



Digital – in the vehicle

Familiarize yourself with the contents of the Operator's Manual directly via the vehicle's multimedia system (menu item "Vehicle"). Start with the quick guide, discover your vehicle's highlights or broaden your knowledge with useful tips.



Vehicle document wallet

Here you can find comprehensive information about operating your vehicle and about services and warranties in printed form.



Digital – on the Internet

You can find the Operator's Manual on the Mercedes-Benz homepage.



Digital – as an App

The Mercedes-Benz Guides App is available free-of-charge in familiar App stores.

Mercedes-AMG GT R Roadster



Mercedes-Benz

Mercedes-AMG GT R Roadster

Operator's Manual

Mercedes-Benz



1905845206

Order no. P190 0614 13 Part no. 190 584 52 06
Edition A2020



Apple® iOS



Android™

Front passenger airbag warning

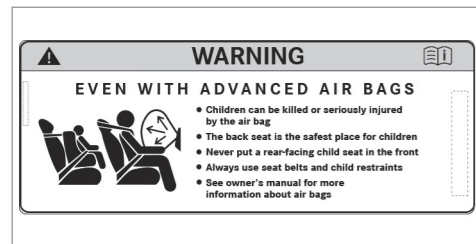

Example

⚠ WARNING Risk of injury or fatal injuries if the front-passenger airbag is enabled

If the front-passenger front airbag is enabled, a child on the front-passenger seat may be struck by the front-passenger airbag during an accident.

NEVER use a rearward-facing child restraint system on a seat with an ENABLED FRONT AIRBAG, DEATH or SERIOUS INJURY to the CHILD can occur.

Observe the chapter "Children in the vehicle".

Publication details

Internet

Further information about Mercedes-Benz vehicles and about Daimler AG can be found on the following websites:

<http://www.mbusa.com> (USA only)

<http://www.mercedes-benz.ca> (Canada only)

Documentation team

©Daimler AG: not to be reprinted, translated or otherwise reproduced, in whole or in part, without written permission from Daimler AG.

Vehicle manufacturer

Daimler AG

Mercedesstrasse 137

70327 Stuttgart

Germany

As at 10.07.18

Welcome to the world of Mercedes-AMG

Before you first drive off, read this Operator's Manual carefully and familiarize yourself with your vehicle. For your own safety and a longer operating lifespan of the vehicle, follow the instructions and warning notices in this Operator's Manual. Disregarding them may lead to damage to the vehicle or injury to people.

Damage to the vehicle resulting from the disregard of the instructions is not covered by the Mercedes-Benz Limited Warranty.

The equipment or model designation of your vehicle may vary according to:

- Model
- Order
- National version
- Availability

Mercedes-AMG reserves the right to introduce changes in the following areas:

- Design
- Equipment
- Technical features

The equipment in your vehicle may therefore differ from that shown in the descriptions and illustrations.

The following are integral parts of the vehicle:

- Digital Operator's Manual
- Printed Operator's Manual
- Maintenance booklet
- Equipment-dependent supplements

Keep these documents in the vehicle at all times. If you sell the vehicle, always pass all of the documents on to the new owner.

Mercedes-Benz USA, LLC

Mercedes-Benz Canada, Inc.

A Daimler Company

1905845206



Symbols	5	Problems with your vehicle	25	Seats and stowing	77
At a glance	6	Reporting safety defects	25	Notes on the correct driver's seat position	77
Cockpit	6	Limited Warranty	26	Seats	77
Warning and indicator lamps	10	QR code for rescue card	26	Steering wheel	84
Overhead control panel	12	Data storage	26	Easy entry and exit feature	86
Door control panel and seat adjustment	14	Copyright	29	Operating the memory function	87
Emergencies and breakdowns	16	Occupant safety	31	Stowage areas	88
Digital Operator's Manual	18	Restraint system	31	Cup holder	90
Calling up the Digital Operator's Manual	18	Seat belts	33	Ashtray and cigarette lighter	91
General notes	19	Airbags	38	Sockets	92
Protecting the environment	19	PRE-SAFE® system	45	Installing/removing the floor mats	93
Genuine Mercedes-Benz parts	19	Safely transporting children in the vehicle	46	Light and visibility	95
Operator's Manual	20	Notes on pets in the vehicle	52	Exterior lighting	95
Service and vehicle operation	21	Opening and closing	54	Interior lighting	99
Operating safety	22	SmartKey	54	Windshield wiper and windshield washer system	100
Declaration of conformity for wireless vehicle components	23	Doors	59	Mirrors	101
Diagnostics connection	23	Trunk	63	Operating the sun visors	104
Qualified specialist workshop	24	Soft top	66	Climate control	105
Correct use of the vehicle	25	Side windows	71	Overview of climate control systems	105
		Anti-theft protection	75	Operating the climate control system	105

Driving and parking	109	Voice Control System	183	Breakdown assistance	312
Driving	109	Notes on operating safety	183	Emergency	312
Race track operation	117	Operation	184	Flat tire	312
DYNAMIC SELECT switch	121	Using the Voice Control System effec-		Battery (vehicle)	318
Automatic transmission	123	tively	185	Tow starting or towing away	324
Refueling	127	Essential voice commands	186	Electrical fuses	328
Parking	130				
Driving and driving safety systems	138				
Vehicle towing instructions	168				
Instrument Display and on-board computer	169	Multimedia system	197	Wheels and tires	330
Instrument Display overview	169	Overview and operation	197	Notes on noise or unusual handling char-	
Overview of the buttons on the steering		System settings	206	acteristics	330
wheel	170	AMG TRACK PACE	216	Notes on regularly inspecting wheels and	
Operating the on-board computer	170	Navigation	221	tires	330
Setting the design	172	Telephone	245	Notes on snow chains	331
Setting the area for additional values	172	Online and Internet functions	267	Tire pressure	331
Overview of displays on the multifunc-		Media	273	Loading the vehicle	338
tion display	173	Radio	285	Tire labeling	342
Adjusting the instrument lighting	173	Sound	292	Definition of terms for tires and loading	347
Menus and submenus	173			Changing a wheel	350
		Maintenance and care	295	Technical data	360
		ASSYST PLUS service interval display	295	Notes on technical data	360
		Engine compartment	296	Vehicle identification plate, VIN and	
		Cleaning and care	302	engine number	360
				Operating fluids	362

4 Contents

Vehicle data 368

Display messages and warning/indicator lamps 371

Display messages 371

Warning and indicator lamps 416

Index 432

In this Operator's Manual, you will find the following symbols:

 **DANGER** Danger due to not observing the warning notices

Warning notices draw your attention to hazards that may endanger your health or life, or the health or life of others.

 Observe the warning notices.

 **ENVIRONMENTAL NOTE** Environmental damage due to failure to observe environmental notes

Environmental notes include information on environmentally responsible behavior or environmentally responsible disposal.

 Observe environmental notes.

 **NOTE** Damage to property due to failure to observe notes on material damage

Notes on material damage inform you of risks which may lead to your vehicle being damaged.

 Observe notes on material damage.

 Useful instructions or further information that could be helpful to you.

 Instruction

(→ page) Further information on a topic

Display Information on the multifunction display/media display

 Highest menu level, which is to be selected in the multimedia system

 Corresponding submenus, which are to be selected in the multimedia system

* Marks a cause

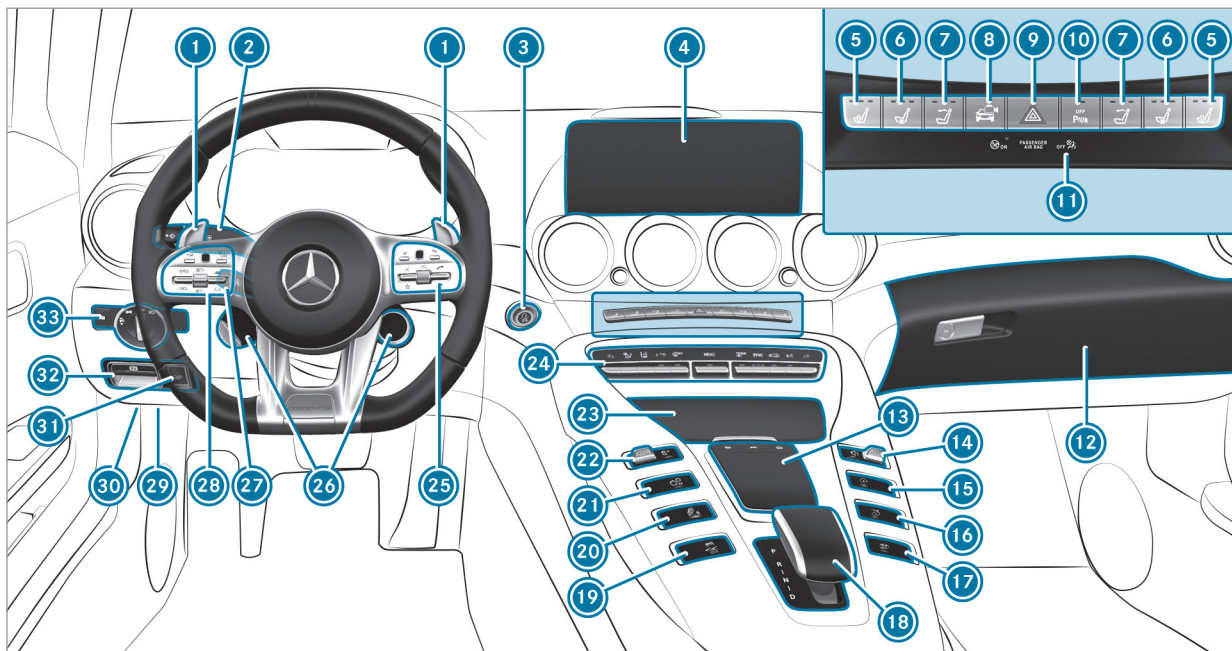

Left-hand drive vehicles

① Steering wheel paddle shifters	→	126	⑩ Extends and retracts active aerodynamics profile	→	156
② Combination switch	→	96	⑪ AMG Performance exhaust system	→	116
③ Start/stop button	→	110	⑫ AMG E-SELECT selector lever	→	123
④ Media display	→	197	⑬ Activates/deactivates ESP®	→	140
⑤ Switches the seat heating on/off	→	82	⑭ AMG adaptive sport suspension system	→	157
⑥ Switches the seat ventilation on/off	→	83	⑮ Manual gearshifting	→	126
⑦ Switches AIRSCARF on/off	→	83	⑯ DYNAMIC SELECT switch	→	121
⑧ Front camera	→	161	⑰ Stowage compartment	→	89
⑨ Hazard warning lamps	→	97	⑱ Climate control systems	→	105
⑩ Parking Assist PARKTRONIC	→	158	⑲ Control panel for the multimedia system (steering wheel)	→	170
⑪ PASSENGER AIR BAG indicator lamp	→	43	⑳ AMG steering-wheel buttons	→	155
⑫ Glove box	→	90	㉑ Adjusts the steering wheel	→	85
⑬ Touchpad	→	197	㉒ Control panel for the on-board computer	→	170
⑭ Control knob for volume and switching sound on/off	→	197	Operates cruise control	→	145
Switches the multimedia system on/off	→	197	Operates Active Distance Assist DISTRONIC	→	148
⑮ ECO start/stop function	→	115			

8 At a glance - Cockpit

29 Diagnostics connection → 23

30 Opens the hood → 296

31 Opens the trunk lid → 63

32 Electric parking brake → 136







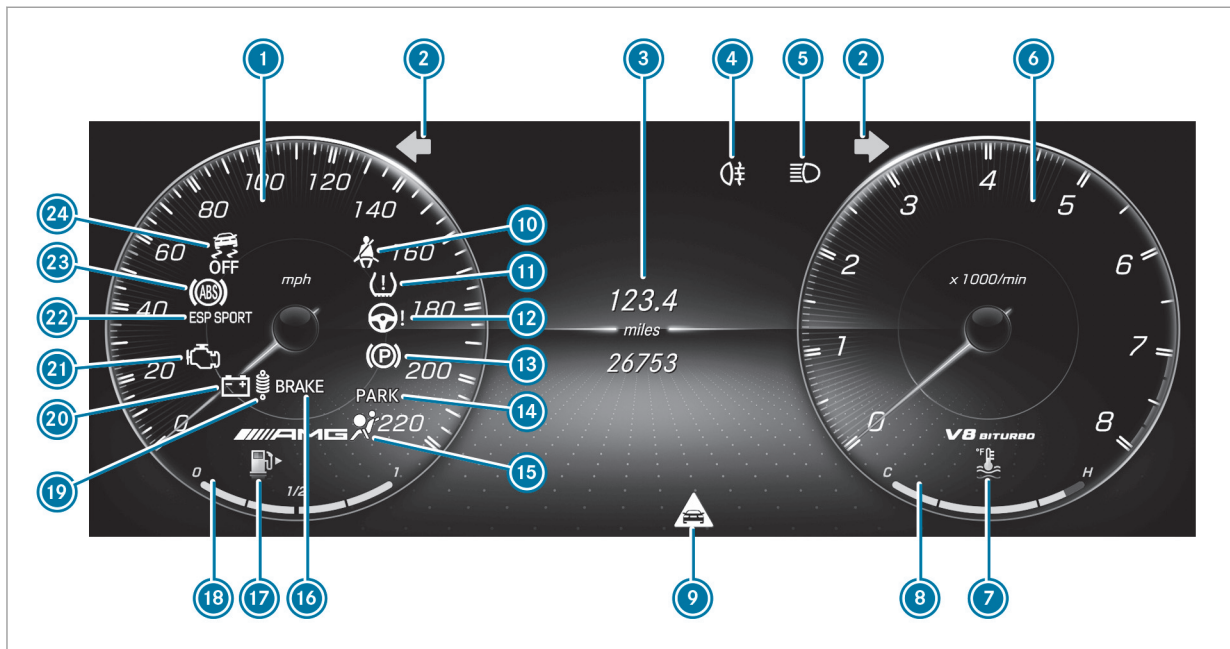

















33 Light switch → 95



10 At a glance - Warning and indicator lamps





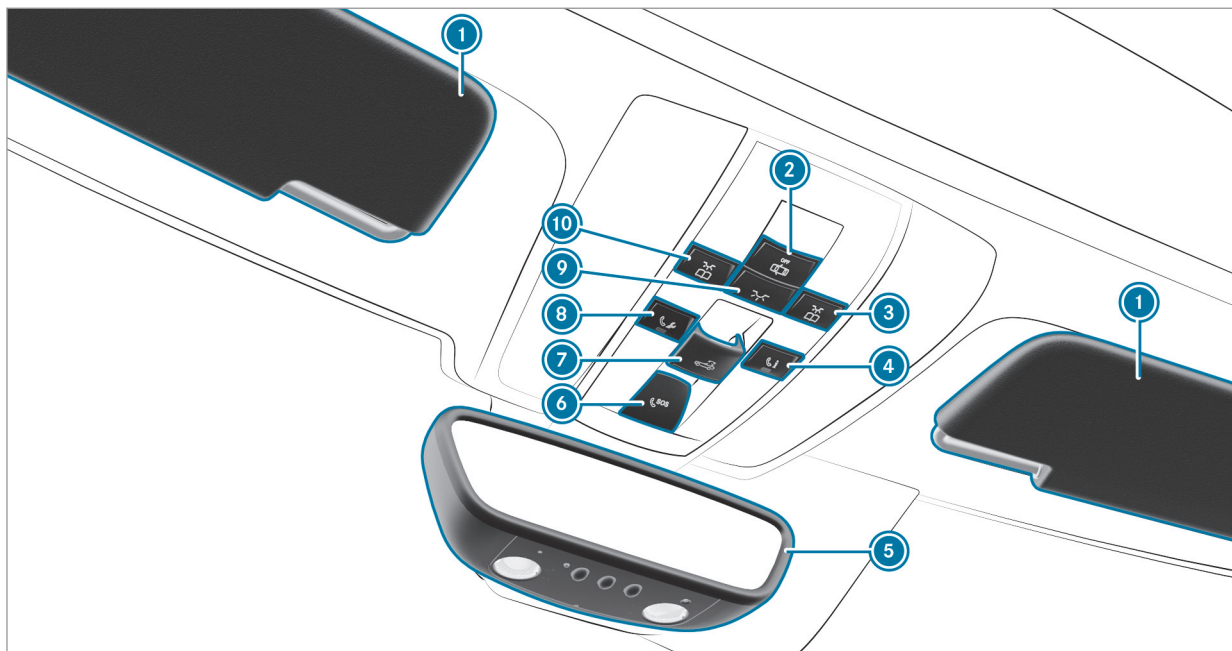

Instrument Display

①	Speedometer	→	169		
②	  Turn signal lights	→	96		
③	Multifunction display	→	173		
④	 Rear fog light	→	96		
⑤	 High beam	→	96		
	 Low beam	→	95		
	 Parking lights	→	95		
⑥	Tachometer	→	169		
⑦	 Coolant too hot/cold	→	426		
⑧	Coolant temperature display	→	169		
⑨	 Distance warning	→	425		
⑩	 Seat belt not fastened	→	424		
⑪	 Tire pressure monitor	→	429		
⑫	 Electric power steering malfunction	→	430		
⑬	 Electric parking brake (yellow)	→	417		
⑭	Electric parking brake applied (red)	→	417		
				 USA only	
				 Canada only	
⑮	 Restraint system	→	417		
⑯	Brakes (red)	→	417		
				 USA only	
				 Canada only	
⑰	 Fuel reserve with fuel filler cap location indicator	→	426		
⑱	Fuel level indicator				
⑲	 AMG adaptive sport suspension system	→	425		
⑳	 Electrical malfunction	→	426		
㉑	 Check Engine	→	426		
㉒	 ESP SPORT	→	417		
㉓	 ABS malfunction	→	417		
㉔	 ESP® OFF	→	417		

12 At a glance - Overhead control panel





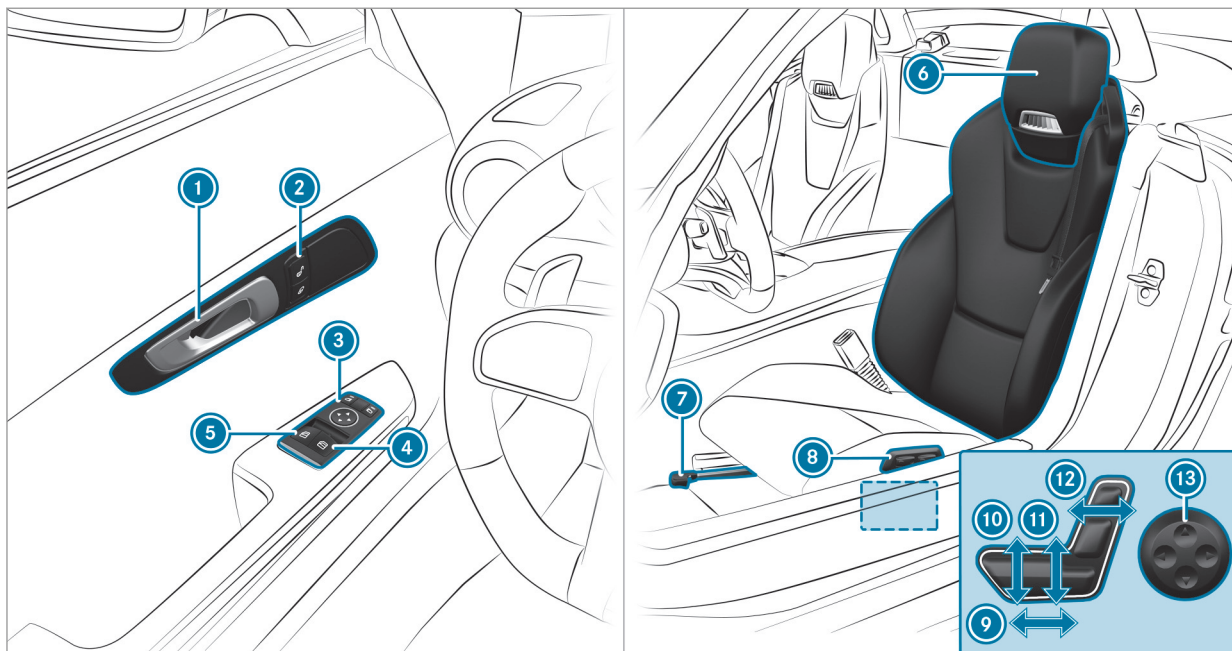

① Sun visors	→	104
②  Switches automatic light control on/off	→	99
③  Switches the right-hand reading lamp on/off	→	99
④ MB Info call button (Mercedes me connect)	→	261
⑤ Inside rearview mirror	→	102
⑥ SOS emergency call system (Mercedes-Benz emergency call system)	→	264

⑦ Opens and closes the soft top	→	66
⑧ Breakdown assistance call button (Mercedes me connect)	→	261
⑨  Switches the interior lighting on/off	→	99
⑩  Switches the left-hand reading lamp on/off	→	99

14 At a glance – Door control panel and seat adjustment



①	Opens the door	→	59	⑧	Operates the memory function	→	87
②	  Locks/unlocks the vehicle	→	59	⑨	Sets the seat fore-and-aft position	→	79
③	Operates the outside mirrors	→	101	⑩	Adjusts the seat cushion inclination	→	79
④	 Opens/closes the right side window	→	71	⑪	Adjusts the seat height	→	79
⑤	 Opens/closes the left side window	→	71	⑫	Adjusts the seat backrest inclination	→	79
⑥	Adjusts the head restraints	→	81	⑬	Adjusts the 4-way lumbar support	→	80
⑦	Adjusts the front seat mechanically	→	77				

16 At a glance - Emergencies and breakdowns

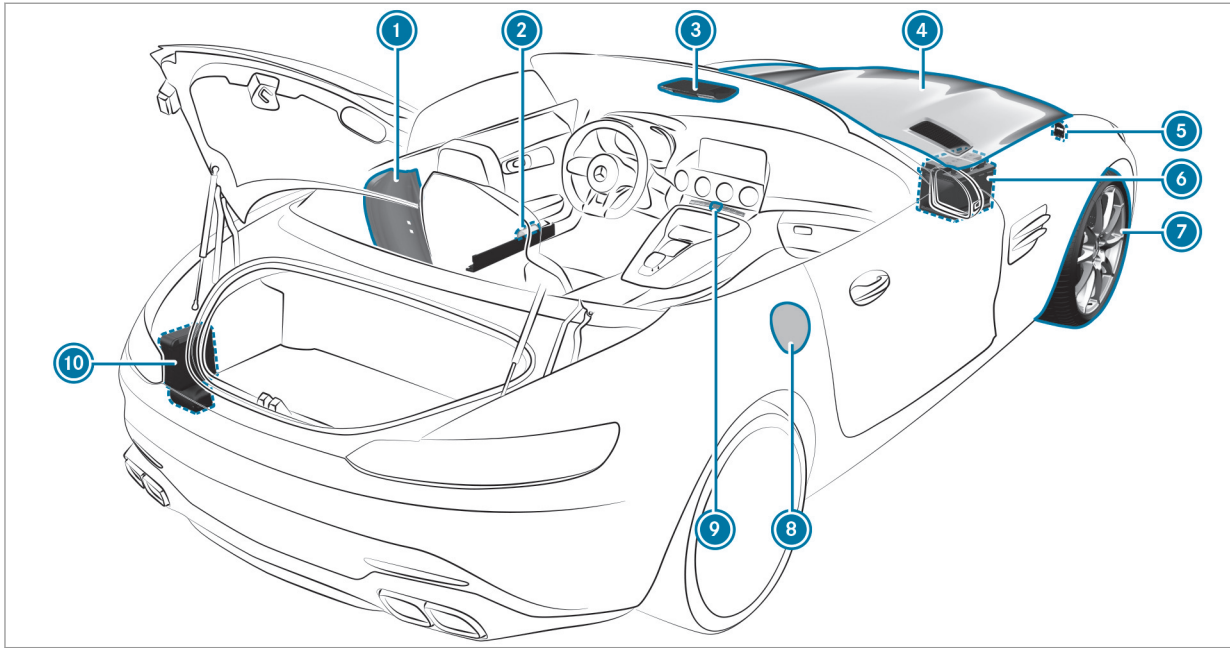

① QR code for accessing the rescue card	→	26
② Safety vests	→	312
③ Buttons for the SOS emergency call system and breakdown assistance	→	264
④ Checking and adding operating fluids	→	362
⑤ Tow-starting and towing away	→	324
⑥ Starting assistance	→	322

⑦ Flat tire	→	312
⑧ Fuel filler flap with instruction labels for tire pressure, fuel type and QR code for accessing the rescue card	→	127
⑨ Hazard warning lamps	→	97
⑩ TIREFIT kit	→	314

Calling up the Digital Operator's Manual

Multimedia system:

→ Vehicle → ⓘ Operator's Manual

▶ Select a menu item.

In addition, you can also call up the Operator's Manual within a main function (e.g. via [Media Info](#)).

The Digital Operator's Manual describes the function and operation of the vehicle and the multimedia system.

For safety reasons, the Digital Operator's Manual is deactivated while driving.



The Digital Operator's Manual contains the following menu items:

- **Search:** allows you to search precisely for keywords.
- **Quick start:** provides you with important information so that you can start using your vehicle immediately.
- **Tips:** provides tips on how to use your vehicle in certain situations.
- **Messages:** provides you with further information about the messages in the instrument cluster.
- **Bookmarks:** provides you with a list of all the bookmarks you have stored yourself.

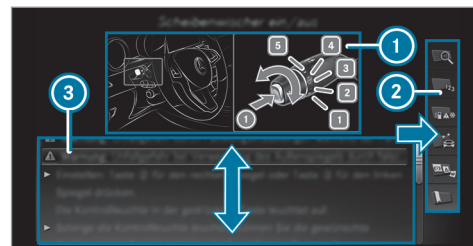

- ① Picture
- ② Menu
- ③ Navigation window

Some sections of the Digital Operator's Manual, such as warnings, can be made visible by highlighting and pressing them.

- ① The Operator's Manual can also be found in the Mercedes-Benz Guides app in all common app stores.

Protecting the environment

 **ENVIRONMENTAL NOTE** Environmental damage due to operating conditions and personal driving style

The pollutant emission of your vehicle is directly related to the way you operate your vehicle.

Help to protect the environment by operating your vehicle in an environmentally responsible manner. Please observe the following recommendations on operating conditions and personal driving style.

Operating conditions:

- ▶ Make sure that the tire pressure is correct.
- ▶ Do not carry any unnecessary weight (e.g. roof luggage racks once you no longer need them).
- ▶ Adhere to the service intervals. A regularly serviced vehicle will contribute to environmental protection.

- ▶ Always have maintenance work carried out at a qualified specialist workshop.

Personal driving style:

- ▶ Do not depress the accelerator pedal when starting the engine.
- ▶ Do not warm up the engine while the vehicle is stationary.
- ▶ Drive carefully and maintain a suitable distance from the vehicle in front.
- ▶ Avoid frequent, sudden acceleration and braking.
- ▶ Change gear in good time and use each gear only up to $\frac{2}{3}$ of its maximum engine speed.
- ▶ Switch off the engine in stationary traffic, e.g. by using the ECO start/stop function.
- ▶ Drive fuel-efficiently. Observe the ECO display for a fuel-efficient driving style.

Environmental issues and recommendations:

It is recommended that you re-use or recycle materials instead of just disposing of them.

The relevant environmental guidelines and regulations serve to protect the environment and must be strictly observed.

Genuine Mercedes-Benz parts

 **ENVIRONMENTAL NOTE** Environmental damage caused by not using recycled/reconditioned components

Daimler AG offers recycled/reconditioned components and parts with the same quality as new parts. The same entitlement from the Limited Warranty is valid as for new parts.

- ▶ Use recycled/reconditioned components and parts from Daimler AG.

! **NOTE** Impairment of the operating efficiency of the restraint systems from installing accessory parts or from repairs or welding

Airbags and Emergency Tensioning Devices, as well as control units and sensors for the restraint systems, may be installed in the following areas of your vehicle:

- Doors
- Door pillars
- Door sills
- Seats
- Cockpit
- Instrument cluster
- Center console
- Lateral roof frame

- ▶ Do not install accessory parts such as audio systems in these areas.
- ▶ Do not carry out repairs or welding.

▶ Have aftermarket installation of accessories carried out at a qualified specialist workshop.

You could jeopardize the operating safety of your vehicle if you use parts, tires and wheels as well as accessories relevant to safety which have not been approved by Mercedes-Benz. Safety-relevant systems, e.g. the brake system, may malfunction. Only use Mercedes-Benz Genuine Parts or parts of equal quality. Only use tires, wheels and accessories that have been specifically approved for your vehicle model.

Mercedes-Benz Genuine Parts are subject to strict quality control. Each part has been specially developed, manufactured or selected for Mercedes-Benz vehicles and fine-tuned for them. Therefore, only Mercedes-Benz Genuine Parts should be used.

More than 300,000 different Mercedes-Benz Genuine Parts are available for Mercedes-Benz models.

All authorized Mercedes-Benz Centers maintain a supply of Mercedes-Benz Genuine Parts for

necessary service and repair work. In addition, strategically located parts delivery centers provide for quick and reliable parts service.

Always specify the vehicle identification number (VIN) (→ page 360) when ordering Mercedes-Benz Genuine Parts.

Operator's Manual

This Operator's Manual describes all models and all standard and optional equipment available for your vehicle at the time of this Operator's Manual going to press. Country-specific differences are possible. Note that your vehicle may not be equipped with all features described. This is also the case for systems and functions relevant to safety. Therefore, the equipment on your vehicle may differ from that in the descriptions and illustrations.

The original purchase agreement for your vehicle contains a list of all of the systems in your vehicle.

Should you have any questions concerning equipment and operation, please consult an authorized Mercedes-Benz Center.

The Operator's Manual and Maintenance Booklet are important documents and should be kept in the vehicle.

Service and vehicle operation

Vehicle operation outside the USA or Canada

When you are abroad with your vehicle, observe the following points:

- service points or replacement parts may not be available immediately.
- unleaded fuel may not be available for vehicles with a catalytic converter. Leaded fuel may cause damage to the catalytic converter.
- the fuel may have an extremely low octane number. Unsuitable fuel can cause engine damage.

Some Mercedes-Benz models are available in Europe through our European Delivery Program. For more information, please consult an authorized Mercedes-Benz service center, or write to one of the following address:

in the USA:

Mercedes-Benz USA, LLC
European Delivery Department
One Mercedes-Benz Drive
Sandy Springs, GA 30328

in Canada:

Mercedes-Benz Canada, Inc.
European Delivery Department
98 Vanderhoof Avenue
Toronto, Ontario M4G 4C9

Maintenance

Your customer advisor confirms the service in the service report.

Roadside Assistance

The Mercedes-Benz Roadside Assistance Program offers technical help in the case of a breakdown. Your calls to the toll-free Roadside Assistance Hotline are answered by our agents 24 hours a day, 365 days a year.

1-800-FOR-MERCEdes (1-800-367-6372) (USA)

1-800-387-0100 (Canada)

You can find further information in the Mercedes-Benz Roadside Assistance Program brochure (USA) or the "Roadside Assistance" section in the maintenance and warranty information booklet (Canada). You will find both in the vehicle document wallet.

Change of address or change of ownership

In the event of a change of address, please send us the "Notification of address change" in the Service and Guarantee booklet or simply call the Mercedes-Benz Customer Assistance Center (USA) on the hotline number 1-800-FOR-MERCEdes (1-800-367-6372) or Customer Service (Canada) on 1-800-387-0100. We can then reach you in a timely fashion, if necessary.

If you sell your Mercedes, please leave all literature in the vehicle so that it is available to the next owner. If you have purchased a used vehicle, please send us the "Notice of Purchase of Used Car" in the Service and Guarantee booklet or simply call the Mercedes-Benz Customer

Assistance Center (USA) at the hotline number 1-800-FOR-MERcedes (1-800-367-6372) or Customer Service (Canada) at 1-800-387-0100.

Possible danger due to substances hazardous to health

In compliance with Proposition 65 ("Prop65"), the following detachable label has been added to each vehicle sold in California:

	WARNING	
<p>Operating, servicing and maintaining a passenger vehicle, pickup truck, van or off-road motor vehicle can expose you to chemicals including engine exhaust, carbon monoxide, phthalates, and lead, which are known to the State of California to cause cancer and birth defects or other reproductive harm. To minimize exposure, avoid breathing exhaust, do not idle the engine except as necessary, service your vehicle in a well-ventilated area and wear gloves or wash your hands frequently when servicing your vehicle. For more information go to www.P65Warnings.ca.gov/passenger-vehicle</p> <p style="text-align: center;"><small>A 000 817 82 02</small></p>		

Operating safety

⚠ WARNING Risk of accident due to malfunctions or system failures

If you do not have the prescribed service/maintenance work or any required repairs carried out, this could result in malfunctions or system failures.

- ▶ Always have the prescribed service/maintenance work as well any required repairs carried out at a qualified specialist workshop.

⚠ WARNING Risk of accident and injury as a result of incorrect modifications to electronic component parts

Modification to electronic components, their software or wiring could impair their function and/or the function of other networked component parts. In particular, systems relevant to safety could also be affected.

As a result, they may no longer function as intended and/or endanger the operating safety of the vehicle.

- ▶ Never tamper with the wiring and electronic component parts or their software.
- ▶ You should have all work on electrical and electronic components carried out at a qualified specialist workshop.

Observe the "On-board electronics" section in "Technical data".

⚠ WARNING Risk of fire due to flammable materials on hot parts of the exhaust system

Flammable material such as leaves, grass or twigs may ignite if they come into contact with hot parts of the exhaust system.

- ▶ When driving on unpaved roads or off-road, regularly check the vehicle underside.

- ▶ Remove trapped plants or other flammable material.
- ▶ If there is damage, consult a qualified specialist workshop immediately.

! NOTE Damage to the vehicle

In the following situations, in particular, there is a risk of damage to the vehicle:

- The vehicle becomes grounded, e.g. on a high curb or an unpaved road
- The vehicle is driven too fast over an obstacle, e.g. a curb, speed bump or pothole
- A heavy object strikes the underbody or chassis components

In situations such as this, the body, the underbody, chassis components, wheels or tires could be damaged without the damage being visible. Components damaged in this way can unexpectedly fail or, in the case of an accident, may not absorb the loads that arise as intended.

If the underbody paneling is damaged, flammable materials such as leaves, grass or twigs can collect between the underbody and the underbody paneling. These materials may ignite if they come into contact with hot parts on the exhaust system.

- ▶ Have the vehicle checked and repaired immediately at a qualified specialist workshop.
- or
- ▶ If driving safety is impaired while continuing your journey, pull over and stop the vehicle immediately in accordance with the traffic conditions, and contact a qualified specialist workshop.

Declaration of conformity for wireless vehicle components

USA: "The wireless devices of this vehicle comply with Part 15 of the FCC Rules. Operation is subject to the following two conditions: 1) These devices may not cause harmful interference, and 2) These devices must accept any interference

received, including interference that may cause undesired operation. Changes or modifications not expressly approved by the party responsible for compliance could void the user's authority to operate the equipment."

Canada: "The wireless devices of this vehicle comply with the Industry Canada license-exempt RSS standard(s). Operation is subject to the following two conditions: (1) These devices may not cause interference, and (2) These devices must accept any interference, including interference that may cause undesired operation of the device."

Diagnostics connection

The diagnostics connection is only intended for the connection of diagnostic devices at a qualified specialist workshop.

⚠ WARNING Risk of accident due to connecting devices to the diagnostics connection

If you connect equipment to a diagnostics connection in the vehicle, it may affect the operation of vehicle systems.

As a result, the operating safety of the vehicle could be affected.

- ▶ Only connect equipment to a diagnostics connection in the vehicle which is approved for your vehicle by Mercedes-Benz.

⚠ WARNING Risk of accident due to objects in the driver's footwell

Objects in the driver's footwell may impede pedal travel or block a depressed pedal.

This jeopardizes the operating and road safety of the vehicle.

- ▶ Stow all objects in the vehicle securely so that they cannot get into the driver's footwell.

- ▶ Always install the floor mats securely and as prescribed in order to ensure that there is always sufficient room for the pedals.

- ▶ Do not use loose floor mats and do not place floor mats on top of one another.

! NOTE Battery discharging from using devices connected to the diagnostics connection

Using devices at the diagnostics connection drains the battery.

- ▶ Check the charge level of the battery.
- ▶ If the charge level is low, charge the battery, e.g. by driving a considerable distance.

Connecting equipment to the diagnostics connection can lead to emissions monitoring information being reset, for example. This may lead to the vehicle failing to meet the requirements of the next emissions inspection during the main inspection.

Qualified specialist workshop

An authorized Mercedes-Benz Center is a qualified specialist workshop. It has the necessary special skills, tools and qualifications to correctly carry out the work required on your vehicle. This particularly applies to safety-relevant works.

For the following, always have your vehicle checked at an authorized Mercedes-Benz Center:

- safety-relevant works
- service and maintenance work
- repair work
- modifications as well as installations and conversions
- work on electronic components

Mercedes-AMG recommends a Mercedes-Benz service center.

Correct use of the vehicle

If you remove any warning stickers, you or others could fail to recognize certain dangers. Leave warning stickers in position.

Observe the following information in particular when driving your vehicle:

- the safety notes in this manual
- technical data for the vehicle
- traffic rules and regulations
- laws and safety standards pertaining to motor vehicles

Problems with your vehicle

If you should experience a problem with your vehicle, particularly one that you believe may affect its safe operation, we urge you to contact an authorized Mercedes-Benz Center immediately to have the problem diagnosed and rectified. If the problem is not resolved to your satisfaction, please discuss the problem again with an authorized Mercedes-Benz Center or, if nec-

essary, contact us at one of the following addresses:

In the USA:

Mercedes-Benz USA, LLC
Customer Assistance Center
One Mercedes-Benz Drive
Sandy Springs, GA 30328

In Canada:

Mercedes-Benz Canada, Inc.
Customer Relations Department
98 Vanderhoof Avenue
Toronto, Ontario M4G 4C9

Reporting safety defects

USA only:

The following text is published as required of manufacturers under Title 49, Code of U.S. Federal Regulations, Part 575 pursuant to the "National Traffic and Motor Vehicle Safety Act of 1966".

If you believe that your vehicle has a defect which could cause a crash or could cause injury or death, you should immediately inform the National Highway Traffic Safety Administration (NHTSA) in addition to notifying Mercedes-Benz USA, LLC.

If NHTSA receives similar complaints, it may open an investigation, and if it finds that a safety defect exists in a group of vehicles, it may order a recall and remedy campaign. However, NHTSA cannot become involved in individual problems between you, your dealer, or Mercedes-Benz USA, LLC.

To contact NHTSA, you may call the Vehicle Safety Hotline toll-free at 1-888-327-4236 (TTY: 1-800-424-9153) (inside the USA); go to <http://www.safercar.gov>; or write to: Administrator, NHTSA, 400 Seventh Street, SW., Washington, DC 20590, USA.

Further information on vehicle safety can be found at: <http://www.safercar.gov>

Limited Warranty

! **NOTE** Damage to the vehicle arising from violation of these operating instructions.

Damage to the vehicle can arise from violation of these operating instructions.

This damage is not covered either by the Mercedes-Benz implied warranty or by the New- or Used-Vehicle Warranty.

- ▶ Follow the instructions in these operating instructions on proper operation of your vehicle as well as on possible vehicle damage.

QR code for rescue card

The QR code is secured in the fuel filler flap and on the opposite side on the B-pillar. In the event of an accident, rescue services can use the QR code to quickly find the appropriate rescue card for your vehicle. The current rescue card contains the most important information about your

vehicle in a compact form, e.g. the routing of the electric lines.

Further information can be obtained at <http://www.mercedes-benz.de/qr-code>.

Data storage

Electronic control units

Electronic control units are installed in your vehicle. Some of these are necessary for the safe operation of your vehicle, while some assist you when driving (driver assistance systems). In addition, your vehicle provides comfort and entertainment functions, which are also made possible by electronic control units.

Electronic control units contain data memories which can temporarily or permanently store technical information about the vehicle's operating state, component loads, maintenance requirements and technical events or malfunctions.

In general, this information documents the state of a component part, a module, a system or the surroundings such as:

- Operating status of system components (e.g. fill levels, battery status, tire pressure)
- Status messages concerning the vehicle or its individual components (e.g. number of wheel revolutions/speed, longitudinal acceleration, lateral acceleration, display of fastened seat belts)
- Malfunctions or faults in important system components (e.g. lights, brakes)
- Information on events leading to vehicle damage
- System reactions in special driving situations (e.g. airbag deployment, intervention of stability control systems)
- Ambient conditions (e.g. temperature, rain sensor)

In addition to providing the actual control unit function, this data assists the manufacturer in detecting and rectifying malfunctions and optimizing vehicle functions. The majority of this

data is temporary and is only processed in the vehicle itself. Only a small portion of the data is stored in the event or fault memory.

When your vehicle is serviced, technical data from the vehicle can be read out by service network employees (e.g. workshops, manufacturers) or third parties (e.g. breakdown services). Services include repair services, maintenance processes, warranty claims and quality assurance measures, for example. The read out is performed via the legally prescribed port for the diagnostics connection in the vehicle. The respective service network locations or third parties collect, process and use the data. They document technical statuses of the vehicle, assist in finding malfunctions and improving quality and are transmitted to the manufacturer, if necessary. Furthermore, the manufacturer is subject to product liability. For this, the manufacturer requires technical data from vehicles.

Fault memories in the vehicle can be reset by a service outlet as part of repair or maintenance work.

Depending on the selected equipment, you can import data into vehicle convenience and information functions yourself.

This includes, for example:

- Multimedia data such as music, films or photos for playback in an integrated multimedia system
- Address book data for use in connection with an integrated hands-free system or an integrated navigation system
- Entered navigation destinations
- Data about the use of Internet services

This data can be saved locally in the vehicle or it is located on a device which you have connected to the vehicle (e.g. a smartphone, USB flash drive or MP3 player). If this data is stored in the vehicle, you can delete it at any time. This data is sent to third parties only at your request, particularly when you use online services in accordance with the settings that you have selected.

You can store or change convenience settings/individualization in the vehicle at any time.

Depending on the equipment, this includes, for example:

- Settings for the seat and steering wheel positions
- Suspension and climate control settings
- Customizations such as interior lighting

If your vehicle is accordingly equipped, you can connect your smartphone or another mobile end device to the vehicle. You can control this by means of the control elements integrated in the vehicle. Images and audio from the smartphone can be output via the multimedia system. Certain information is simultaneously transferred to your smartphone.

Depending on the type of integration, this can include:

- General vehicle data
- Position data

This allows you to use selected apps on your smartphone, such as navigation or music playback. There is no further interaction between the smartphone and the vehicle; in particular, vehicle data is not directly accessible. Which type of

further data processing occurs is determined by the provider of the specific app used. Which settings you can make, if any, depends on the specific app and the operating system of your smartphone.

Online services

Wireless network connection

If your vehicle has a wireless network connection, it enables data to be exchanged between your vehicle and additional systems. The wireless network connection is enabled via the vehicle's transmission and reception unit or via connected mobile end devices (e.g. smartphones). Online functions can be used via the wireless network connection. This includes online services and applications/apps provided by the manufacturer or other providers.

Manufacturer's services

Regarding online services of the manufacturer, the individual functions are described by the manufacturer in a suitable place (e.g. Operator's Manual, website of the manufacturer) along with the relevant data protection information. Per-

sonal data may be used for the provision of online services. Data is exchanged via a secure connection, e.g. the manufacturer's designated IT systems. Personal data is collected, processed and used via the provision of services exclusively on the basis of legal permissions or with prior consent.

The services and functions (sometimes subject to a fee) can usually be activated or deactivated. In some cases, this also applies to the entire vehicle's data connection. This excludes, in particular, legally prescribed functions and services.

Third party services

If it is possible to use online services from other providers, these services are the responsibility of the provider in question and subject to that provider's data protection conditions and terms of use. The manufacturer has no influence on the content exchanged.

For this reason, please ask the service provider for information about the type, extent and purpose of the collection and use of personal data when services are provided by third parties.

Multimedia system/Mercedes me connect

If the vehicle is equipped with the multimedia system or Mercedes me connect, additional data about the vehicle's operation, the use of the vehicle in certain situations, and the location of the vehicle may be compiled by the multimedia system or Mercedes me connect.

For additional information please refer to the chapter "Multimedia system" and/or the Mercedes me connect Terms and Conditions.

Event data recorders

USA only:

This vehicle is equipped with an event data recorder (EDR). The main purpose of an EDR is to record, in certain crash or near crash-like situations, such as an airbag deployment or hitting a road obstacle, data that will assist in understanding how a vehicle's systems performed. The EDR is designed to record data related to vehicle dynamics and safety systems for a short period of time, typically 30 seconds or less.

The EDR in this vehicle is designed to record such data as:

- How various systems in your vehicle were operating
- Whether or not the driver and front passenger seat belts were buckled/fastened
- How far (if at all) the driver was depressing the accelerator and/or brake pedal and
- How fast the vehicle was traveling

This data can help provide a better understanding of the circumstances in which accidents and injuries occur. NOTE: EDR data is recorded by your vehicle only if a non-trivial crash situation occurs; no data is recorded by the EDR under normal driving conditions and no personal data (e.g. name, gender, age and accident location) is recorded. However, other parties, such as law enforcement, could combine EDR data with the type of personally identifying data routinely acquired during a crash investigation.

Access to the vehicle and/or the EDR is needed to read data that is recorded by the EDR, and special equipment is required. In addition to the vehicle manufacturer, other parties that have the

special equipment, such as law enforcement, can read the information by accessing the vehicle or the EDR.

EDR data may be used in civil and criminal matters as a tool in accident reconstruction, accident claims and vehicle safety. Since the Crash Data Retrieval (CDR) tool that is used to extract data from the EDR is commercially available, Mercedes-Benz USA, LLC ("MBUSA") expressly disclaims any and all liability arising from the extraction of this information by unauthorized Mercedes-Benz personnel.

MBUSA will not share EDR data with others without the consent of the vehicle owner or, if the vehicle is leased, without the consent of the lessee. Exceptions to this representation include responses to subpoenas by law enforcement; by federal, state or local government; in connection with or arising out of litigation involving MBUSA or its subsidiaries and affiliates; or, as required by law.

Warning: the EDR is a component of the Restraint System Module. Tampering with, altering, modifying or removing the EDR component

may result in a malfunction of the Restraint System Module and other systems.

State laws or regulations regarding EDRs that conflict with federal regulation are pre-empted. This means that in the event of such conflict, the federal regulation governs. As of December 2016, 17 states have enacted laws relating to EDRs.

Copyright

Free and open source software

Information on license for free and open-source software used in your vehicle can be found on the data carrier in your vehicle document wallet and with updates on the following website:

<http://www.mercedes-benz.com/opensource>

Registered trademarks

- Bluetooth® is a registered trademark of Bluetooth SIG Inc.
- DTS™ is a registered trademark of DTS, Inc.

30 General notes

- Dolby® and MLP™ are registered trademarks of DOLBY Laboratories.
- BabySmart™, ESP® and PRE-SAFE® are registered trademarks of Daimler AG.
- HomeLink® is a registered trademark of Johnson Controls.
- iPod® and iTunes® are registered trademarks of Apple Inc.
- Burmester® is a registered trademark of Burmester Audiosysteme GmbH.
- Microsoft® and Windows Media® are registered trademarks of Microsoft Corporation.
- SIRIUS® is a registered trademark of Sirius XM Radio Inc.
- HD Radio™ is a registered trademark of iBiquity Digital Corporation.
- Gracernote® is a registered trademark of Gracernote, Inc.
- ZAGATSurvey® and related brands are registered trademarks of ZagatSurvey, LLC.

Restraint system

Protection by the restraint system

The restraint system includes the following components:

- Seat belt system
- Airbags
- Child restraint system

The restraint system can help prevent the vehicle occupants from coming into contact with parts of the vehicle interior in the event of an accident. In the event of an accident, the restraint system can also reduce the forces to which the vehicle occupants are subjected.

A seat belt can only provide the best level of protection if it is worn correctly. Depending on the detected accident situation, Emergency Tensioning Devices and/or airbags supplement the protection offered by a correctly worn seat belt. Emergency Tensioning Devices and/or airbags are not deployed in every accident.

In order for the restraint system to provide the intended level of protection, each vehicle occupant must observe the following information:

- Fasten seat belts correctly.
- Sit in an almost upright seat position with their back against the seat backrest.
- Sit with their feet resting on the floor, if possible.
- Always secure persons under 5 ft (1.50 m) tall in an additional restraint system suitable for Mercedes-Benz vehicles.

However, no system available today can completely eliminate injuries and fatalities in every accident situation. In particular, the seat belt and airbag generally do not protect against objects penetrating the vehicle from the outside. It is also not possible to completely rule out the risk of injury caused by the airbag deploying.

Reduced restraint system protection

▲ WARNING Risk of injury or death from modifications to the restraint system

The restraint system can no longer function correctly after alterations have been made.

The restraint system may then not protect the vehicle occupants as intended by failing in an accident or triggering unexpectedly, for example

- ▶ Never alter the parts of the restraint system.
- ▶ Never tamper with the wiring or any electronic component parts or their software.

If it is necessary to modify the vehicle to accommodate a person with disabilities, contact an authorized Mercedes-Benz Center for details.



USA only: for details, contact our Customer Assistance Center on 1-800-FOR-MERCEDES (1-800-367-6372).

Restraint system functionality

When the ignition is switched on, a self-test is performed, during which the  restraint system warning lamp lights up. It goes out no later than a few seconds after the vehicle is started. The components of the restraint system are then functional.

Malfunctioning restraint system

A malfunction has occurred in the restraint system if:

- The  restraint system warning lamp does not light up when the ignition is switched on
- The  restraint system warning lamp lights up continuously or repeatedly during a journey

⚠ WARNING Risk of injury due to malfunctions in the restraint system

If the restraint system is malfunctioning, restraint system components may be trig-

gered unintentionally or may not deploy as intended during an accident. This may affect the Emergency Tensioning Devices or airbags, for example.

- ▶ Have the restraint system checked and repaired immediately at a qualified specialist workshop.

Function of the restraint system in an accident

How the restraint system works is determined by the severity of the impact detected and the type of accident anticipated:

- Frontal impact
- Rear impact
- Side impact
- Rollover

The activation thresholds for the components of the restraint system are determined based on the evaluation of the sensor values measured at various points in the vehicle. This process is pre-emptive in nature. The triggering/deployment of

the components of the restraint system must take place in good time at the start of the collision.

Factors which can only be seen and measured after a collision has occurred do not play a decisive role in the deployment of an airbag. Nor do they provide an indication of airbag deployment.

The vehicle may be deformed significantly without an airbag being deployed. This is the case if only parts which are relatively easily deformed are affected and the rate of vehicle deceleration is not high. Conversely, an airbag may be deployed even though the vehicle suffers only minor deformation. If very rigid vehicle parts such as longitudinal members are hit, for example, this may result in sufficiently high levels of vehicle deceleration.

The components of the restraint system can be activated or deployed independently of each other:

Component	Detected deployment situation
Emergency Tensioning Devices	Frontal impact, rear impact, side impact, rollover
Driver's airbag, front passenger airbag	Frontal impact
Knee airbag	Frontal impact
Side airbag	Side impact
Head airbag	Side impact, rollover, frontal impact

The front passenger airbag can only be deployed in an accident if the PASSENGER AIR BAG OFF indicator lamp is off. If the front passenger seat is occupied, make sure, both before and during the journey, that the status of the front passenger airbag is correct (→ page 43).

⚠ WARNING Risk of burns from hot air bag components

The air bag parts are hot after an air bag has been deployed.

- ▶ Do not touch the air bag parts.
- ▶ Have a deployed air bag replaced at a qualified specialist workshop as soon as possible.

Mercedes-Benz recommends that you have the vehicle towed to a qualified specialist workshop after an accident. Take this into account, particularly if an Emergency Tensioning Device is triggered or an airbag deployed.

If the Emergency Tensioning Devices are triggered or an airbag is deployed, you will hear a bang, and a small amount of powder may also be released:

- The bang will not generally affect your hearing.
- In general, the powder released is not hazardous to health but may cause short-term

breathing difficulties to persons suffering from asthma or other pulmonary conditions.

Provided it is safe to do so, leave the vehicle immediately or open the window in order to prevent breathing difficulties.

Airbags and pyrotechnic Emergency Tensioning Devices contain perchlorate material, which may require special handling or environmental protection measures. National guidelines regarding waste disposal must be observed. In California, see <http://www.dtsc.ca.gov/HazardousWaste/Perchlorate/index.cfm>.

Seat belts

Protection provided by the seat belt

Always fasten your seat belt correctly before starting a journey. A seat belt can only provide the best level of protection if it is worn correctly.

⚠ WARNING Risk of injury or death due to incorrectly fastened seat belt

If the seat belt is not worn correctly, it cannot perform its intended protective function. In addition, an incorrectly fastened seat belt can also cause injuries, for example, in the event of an accident or when braking or changing direction suddenly.

- ▶ Always ensure that all vehicle occupants have their seat belts fastened correctly and are sitting properly.

Always observe the instructions about the correct driver's seat position and adjusting the seats (→ page 77).

In order for the correctly worn seat belt to provide the intended level of protection, each vehicle occupant must observe the following information:

- The seat belt must not be twisted and must fit tightly and snugly across the body.

- The seat belt must be routed across the center of the shoulder and as low down across the hips as possible.
- The shoulder section of the seat belt should not touch your neck nor be routed under your arm or behind your back.
- Avoid wearing bulky clothing, e.g. a winter coat.
- Push the lap belt down as far as possible across your hips and pull tight with the shoulder section of the belt. Never route the lap belt across your abdomen.

Pregnant women must also take particular care with this.

- Never route the seat belt across sharp, pointed, abrasive or fragile objects.
- Only one person may use each seat belt at any one time. Infants and children must never travel sitting on the lap of a vehicle occupant.
- Never secure objects with a seat belt if the seat belt is being used by one of the vehicle's occupants. Always observe the instruc-

tions for loading the vehicle when securing objects, luggage or loads (→ page 88).

Also ensure that no objects, e.g. a cushion, are ever placed between a person and the seat.

The co-driver seat belt is equipped with a special seatbelt retractor.

Activate or deactivate the special seatbelt retractor of the seat belt (→ page 50).

If children are traveling in the vehicle, be sure to observe the instructions and safety notes on "Children in the vehicle" (→ page 47).

Reduced seat belt protection

⚠ WARNING Risk of injury or death due to incorrect seat position

The seat belt does not offer the intended level of protection if you have not moved the seat backrest to an almost vertical position.

When braking or in the event of an accident, you could slide underneath the seat belt and

sustain abdominal or neck injuries, for example.

- ▶ Adjust the seat properly before beginning your journey.
- ▶ Always ensure that the seat backrest is in an almost vertical position and that the shoulder section of your seat belt is routed across the center of your shoulder.

▲ WARNING Risk of injury or death when additional restraint systems are not used for persons with a smaller build

Persons under 5 ft (1.50 m) tall cannot wear the seat belt correctly without a suitable additional restraint system.

If the seat belt is not worn correctly, it cannot perform its intended protective function. In addition, an incorrectly fastened seat belt can also cause injuries, for example, in the event of an accident or when braking or changing direction suddenly.

- ▶ Always secure persons under 5 ft (1.50 m) tall in a suitable restraint system.

▲ WARNING Risk of injury or death due to damaged or modified seat belts

Seat belts cannot provide protection in the following situations:

- The seat belt is damaged, has been modified, is extremely dirty, bleached or dyed
- The seat belt buckle is damaged or extremely dirty
- Modifications have been made to the Emergency Tensioning Device, seat belt anchorage or seat belt retractor

Seat belts may sustain non-visible damage in an accident, e.g. due to glass splinters.

Modified or damaged seat belts could tear or fail in the event of an accident, for example.

Modified Emergency Tensioning Devices may be deployed unintentionally or not function as intended.

- ▶ Never modify the seat belts, Emergency Tensioning Devices, seat belt anchorages or seat belt retractors.
- ▶ Make sure that the seat belts are not damaged, are not worn and are clean.
- ▶ Always have the seat belts checked immediately after an accident at a qualified specialist workshop.

Only use seat belts which have been approved for your vehicle by Mercedes-Benz.

Vehicles with AMG Performance seats

The AMG Performance seat is designed for the standard three-point seat belt. If you install a different multipoint seat belt, e.g. sport or racing seat belts, the restraint system cannot provide the intended level of protection.

▲ WARNING Risk of injury or fatal injury due to modified seat belt systems

If you feed seat belts through the opening in the seat backrest, the seat backrest may be damaged or may even break in the event of an accident.

- ▶ Only use the standard three-point seat belt.
- ▶ Never modify the seat belt system.

All vehicles

⚠ WARNING Risk of injury or death from deployed pyrotechnic Emergency Tensioning Devices

Pyrotechnic Emergency Tensioning Devices that have been deployed are no longer operational and are unable to perform their intended protective function.

- ▶ Therefore, have deployed pyrotechnic Emergency Tensioning Devices immediately replaced at a qualified specialist workshop.

Mercedes-Benz recommends that you have the vehicle towed to a qualified specialist workshop after an accident.

! **NOTE** Damage caused by trapping the seat belt

If an unused seat belt is not fully retracted, it may become trapped in the door or in the seat mechanism.

- ▶ Always ensure that an unused seat belt is fully retracted.

Fastening seat belts

If the seat belt is pulled quickly or sharply, the seat belt retractor locks. The seat belt strap cannot be pulled out any further.

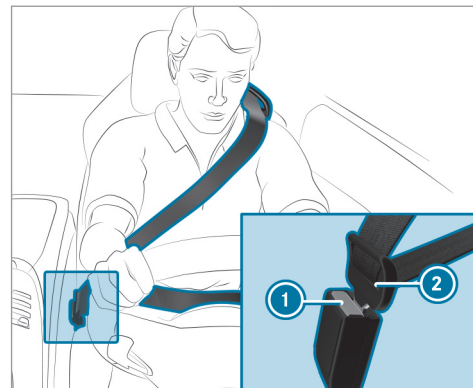

- ▶ Always engage seat belt tongue ② of the seat belt into seat belt buckle ① of the corresponding seat.

Vehicles with automatic front passenger air-bag shutoff:

! **NOTE** Deployment of the Emergency Tensioning Device and side air bag when the front passenger seat is unoccupied

If the seat belt tongue is engaged in the seat belt buckle of the unoccupied front passenger seat, the Emergency Tensioning Device and the side air bag may also deploy in the event of an accident along with other systems.

- ▶ Only one person should use each seat belt at any one time.

Vehicles without automatic front passenger airbag shutoff:

! **NOTE** Deployment of the Emergency Tensioning Device when the front-passenger seat is unoccupied

If the seat belt tongue is engaged in the seat belt buckle of the unoccupied front-passenger seat, the Emergency Tensioning Device may also deploy in the event of an accident along with other systems.

- ▶ Only one person should use each seat belt at any one time.

Seat belt adjustment function

Vehicles with PRE-SAFE®: If the seat belt is not pulled tightly across your body, the seat belt adjustment may automatically apply a certain tightening force. Do not hold the seat belt tightly while it is adjusting.

You can activate and deactivate the seat belt adjustment function using the multimedia system (→ page 37).

Releasing seat belts

- ▶ Press the release button in the seat belt buckle and guide the seat belt back with the seat belt tongue.

Activating/deactivating seat belt adjustment via the multimedia system

Multimedia system:

↳ Vehicle ▶  Vehicle Settings
 ▶▶ Belt Adjustment

- ▶ Activate or deactivate the function.

Seat belt warning function for the driver and front passenger

The  seat belt warning lamp in the Instrument Display is a reminder that all vehicle occupants must wear their seat belts correctly.

The  seat belt warning lamp lights up for six seconds every time the vehicle is started.

In addition, a warning tone may sound.

When the driver's and front passenger's doors are closed and the driver and front passenger have fastened their seat belts, the seat belt warning goes out.

In the following cases, the seat belt warning lights up during a journey if:

- The vehicle speed exceeds 15 mph (25 km/h) and the driver's or front passenger seat belt is not fastened.
- The driver or front passenger unfastens their seat belt while the vehicle is in motion.

Airbags

Overview of airbags

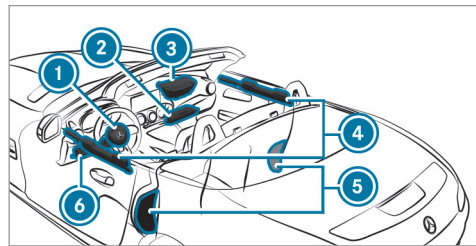

- ① Driver's airbag
- ② Front passenger knee airbag

- ③ Front passenger airbag
- ④ Head airbag
- ⑤ Side airbag
- ⑥ Driver's knee bag

The installation location of an airbag can be recognized by the AIRBAG marking.

When enabled, an airbag can provide additional protection for the respective vehicle occupant.

Potential protection from each airbag:

AIRBAG	Potential protection for:
Knee airbag	Thigh, knee and lower leg
Driver's airbag, front passenger airbag	Head and ribcage
Head airbag	Head
Side airbag	Ribcage

⚠ WARNING Risk of injury or fatal injuries if the front-passenger airbag is enabled

If the front-passenger front airbag is enabled, a child on the front-passenger seat may be struck by the front-passenger airbag during an accident.

NEVER use a rearward-facing child restraint system on a seat with an ENABLED FRONT AIRBAG, DEATH or SERIOUS INJURY to the CHILD can occur.

When installing a child restraint system on the front passenger seat, observe the vehicle-specific information (→ page 51). Also, always observe the notes on rearward-facing or forward-facing child restraint systems on the front passenger seat.

Vehicles with automatic front passenger airbag shutoff:

The front passenger airbag can only be deployed in an accident if the PASSENGER AIR BAG OFF indicator lamp is off. If the front passenger seat is occupied, make sure, both before and during

the journey, that the status of the front passenger airbag is correct (→ page 43).

! **NOTE** Important points to remember if the front passenger seat is unoccupied

In an accident, the components of the restraint system may deploy unnecessarily on the front passenger side if:

- There are heavy objects on the front passenger seat.
- The seat belt tongue is engaged in the seat belt buckle of the front passenger seat and the front passenger seat is unoccupied.

- ▶ Stow objects in a suitable place.
- ▶ Only one person should use each seat belt at any one time.

Depending on the detected accident situation, the head airbag on the front passenger side may deploy. The airbag is deployed regardless of whether the front passenger seat is occupied.

Protection by the airbags

Depending on the accident situation, an airbag may supplement the protection offered by a correctly fastened seat belt.

! **WARNING** Risk of injury or death due to incorrect seat position

If you deviate from the correct seat position, the airbag cannot perform its intended protective function and deployment may even cause further injuries.

In order to avoid risks, each vehicle occupant must always make sure of the following:

- Fasten seat belts correctly. Pregnant women must take particular care to ensure that the lap belt never lies across the abdomen.
- Adopt the correct seat position and keep as far away as possible from the airbags.
- Observe the following information.

- ▶ Always make sure that there are no objects between the airbag and vehicle occupant.

To avoid the risks resulting from the deployment of an airbag, each vehicle occupant must observe the following information in particular:

- Before starting your journey, adjust your seat correctly; the driver's seat and front passenger seat should be moved as far back as possible.

When doing so, always observe the information on the correct driver's seat position (→ page 77).

- Only hold the steering wheel by the steering wheel rim. This allows the airbag to be fully deployed.
- Always lean against the seat backrest when the vehicle is in motion. Do not lean forwards or against the door or side window. You may otherwise be in the deployment area of the airbags.
- Always keep your feet on the floor. Do not put your feet on the cockpit, for example.

Your feet may otherwise be in the deployment area of the airbag.

- If children are traveling in the vehicle, observe the additional notes (→ page 47).
- Always stow and secure objects correctly.

Objects in the vehicle interior may prevent an airbag from functioning correctly. Each vehicle occupant must always make sure of the following in particular:

- There are no people, animals or objects between the vehicle occupants and an airbag.
- There are no objects between the seat, door and door pillar (B-pillar).
- There are no hard objects, e.g. coat hangers, hanging on the grab handles or coat hooks.
- There are no accessory parts, such as mobile navigation devices, mobile phones or cup holders, attached to the vehicle within the deployment area of an airbag, e.g. on the cockpit, on the door, on the side window or on the side wall trim.

In addition, no connecting cables, tensioning straps or retaining straps must be routed or attached to the vehicle within the deployment area of an airbag. Always comply with the accessory manufacturer's installation instructions and, in particular, the notes on suitable places for installation.

- There are no heavy, sharp-edged or fragile objects in the pockets of your clothing. Store such objects in a suitable place.

Limited protection provided by airbags

⚠ WARNING Risk of injury due to modifications to the airbag cover

If you modify the cover of an airbag or affix objects such as stickers to it, the airbag may no longer function correctly.

- ▶ Never modify the cover of an airbag and do not affix objects to it.

The installation location of an airbag is identified by the AIRBAG symbol (→ page 38).

⚠ WARNING Risk of injury or death due to the use of unsuitable seat covers

Unsuitable seat covers can obstruct or prevent the deployment of air bags integrated into the seats.

Consequently, the air bags cannot protect vehicle occupants as they are designed to do. In addition, operation of the automatic front passenger air bag shutoff may be restricted.

- ▶ You should only use seat covers that have been approved for the corresponding seats by Mercedes-Benz.

⚠ WARNING Risk of injury due to malfunctions of the sensors in the door paneling

Sensors to control the airbags are located in the doors. Modifications or work not performed correctly to the doors or door paneling, as well as damaged doors, can lead to the function of the sensors being impaired. The airbags might therefore not function properly any more.

Consequently, the airbags cannot protect vehicle occupants as they are designed to do.

- ▶ Never modify the doors or parts of the doors.
- ▶ Always have work on the doors or door paneling carried out at a qualified specialist workshop.

⚠ WARNING Risk of injury due to deployed airbag

A deployed airbag no longer has a protective function and cannot protect as intended in the event of an accident.

- ▶ Have the vehicle towed to a qualified specialist workshop in order to have the deployed airbag replaced.

Have deployed airbags replaced immediately.

Status of the front passenger front airbag

Function of the automatic front passenger airbag shutoff

The automatic front passenger airbag shutoff is able to detect whether the front passenger seat is occupied by a person or a child restraint system. The front passenger airbag and front passenger knee airbag are enabled or disabled accordingly.

When installing a child restraint system on the front passenger seat, always make sure of the following:

- Ensure that the child restraint system is positioned correctly (→ page 46).
- Always observe the child restraint system manufacturer's installation instructions.
- Never place objects, e.g. cushions, under or behind the child restraint system.
- Fully retract the seat cushion length adjustment.
- The entire base of the child restraint system must always rest on the seat cushion of the front-passenger seat.

- The backrest of the forward-facing child restraint system must lie as flat as possible against the backrest of the front-passenger seat.
- The child restraint system must not touch the roof or be put under strain by the head restraints. Adjust the seat backrest inclination and the head restraint setting accordingly.

⚠ WARNING Risk of injury or death due to objects between the sitting surface and the child restraint system

Objects between the sitting surface and the child restraint system could affect the function of the automatic front passenger airbag shutoff.

This could result in the front passenger airbag not functioning as intended during an accident.

- ▶ Do not place any objects between the sitting surface and the child restraint system.

- ▶ The entire base of the child restraint system must always rest on the sitting surface of the front passenger seat.
- ▶ The backrest of the forward-facing child restraint system must, as far as possible, be resting on the seat backrest of the front passenger seat.
- ▶ Always comply with the child restraint system manufacturer's installation instructions.

A person on the front passenger seat must observe the following information:

- Fasten seat belts correctly (→ page 33).
- Sit in an almost upright seat position with their back against the seat backrest.
- Sit with their feet resting on the floor, if possible.

The front passenger airbag may otherwise be disabled by mistake, for example in the following situations:

- The front passenger transfers their weight by supporting themselves on a vehicle armrest.

- The front passenger sits in such a way that their weight is raised from the sitting surface.

▲ WARNING Risk of injury or death due to deactivated front passenger airbag

If the PASSENGER AIR BAG OFF indicator lamp is lit, the front passenger airbag is disabled. It will not be deployed in the event of an accident and cannot perform its intended protective function.

A person in the front passenger seat could then, for example, come into contact with the vehicle interior, especially if the person is sitting too close to the cockpit.

If the front passenger seat is occupied, always ensure that:

- The classification of the person in the front passenger seat is correct and the front passenger airbag is enabled or disabled in accordance with the person in the front passenger seat.

- The front passenger seat has been moved as far back as possible.
- The person is seated correctly.
- ▶ Ensure, both before and during the journey, that the status of the front passenger airbag is correct.

If the front passenger seat is occupied, the classification of the person or child restraint system on the front passenger seat takes place after the front passenger airbag shutoff self-test. The PASSENGER AIR BAG indicator lamps display the status of the front passenger airbag.

Always observe the notes on the function of the PASSENGER AIR BAG indicator lamps (→ page 43).

Function of the PASSENGER AIR BAG indicator lamps

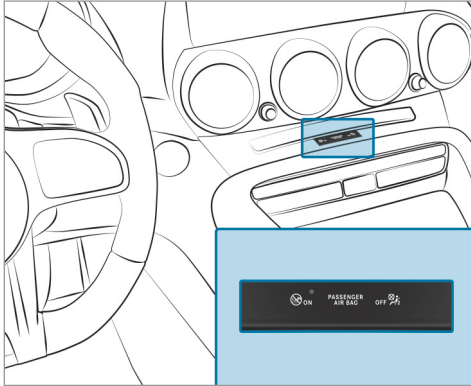

Self-test of automatic front passenger airbag shutoff

When the ignition is switched on, a self-test is performed during which the two PASSENGER AIR BAG ON and OFF indicator lamps light up simultaneously.

The status of the front passenger airbag is displayed after the self-test:

- PASSENGER AIR BAG ON lights up for 60 seconds, subsequently both indicator lamps are off (PASSENGER AIR BAG ON and OFF): the front passenger airbag is able to deploy in the event of an accident.
- PASSENGER AIR BAG OFF lights up continuously: the front passenger airbag is disabled. It will then not be deployed in the event of an accident.

If the PASSENGER AIR BAG ON indicator lamp is off, only the PASSENGER AIR BAG OFF indicator lamp shows the status of the front passenger airbag. The PASSENGER AIR BAG OFF indicator lamp may be lit continuously or be off.

If the PASSENGER AIR BAG OFF indicator lamp and the  restraint system warning lamp light up simultaneously, the front passenger seat may not be used. Also in this case, do not install a child restraint system on the front passenger seat. Have automatic front passenger airbag shutoff checked and repaired immediately at a qualified specialist workshop.

Status display

If the front passenger seat is occupied, ensure, both before and during the journey, that the status of the front passenger airbag is correct for the current situation.

After installing a rearward-facing child restraint system on the front passenger seat: PASSENGER AIR BAG OFF must be lit continuously.

⚠ WARNING Risk of injury or death from using a rearward-facing child restraint system when the front passenger front airbag is enabled

If you secure a child in a rearward-facing child restraint system on the front passenger seat and the PASSENGER AIR BAG OFF indicator lamp is off, the front passenger airbag can deploy in the event of an accident.

The child could be struck by the airbag.

Always ensure that the front passenger airbag is deactivated. The PASSENGER AIR BAG OFF indicator lamp must be lit.

NEVER use a rearward-facing child restraint system on a seat protected by an ENABLED FRONT AIRBAG in front of it, DEATH or SERIOUS INJURY to the CHILD can occur.

When installing a child restraint system on the front passenger seat, observe the vehicle-specific information (→ page 51).

Depending on the child restraint system and the stature of the child, the PASSENGER AIR BAG OFF indicator lamp may be off. In this case, do not install the rearward-facing child restraint system on the front passenger seat.

After installing a forward-facing child restraint system on the front passenger seat:

depending on the child restraint system and the stature of the child, PASSENGER AIR BAG OFF may be lit continuously or be off. Always observe the following information.

⚠ WARNING Risk of injury or fatal injury due to incorrect positioning of the child restraint system

If you secure a child in a forward-facing child restraint system on the front passenger seat and you position the front passenger seat too close to the cockpit, in the event of an accident, the child could:

- come into contact with parts of the vehicle's interior if the PASSENGER AIR BAG OFF indicator lamp is lit, for example.
- be struck by the airbag if the PASSENGER AIR BAG OFF indicator lamp is off.

▶ Always move the front passenger seat as far back as possible. Always make sure that the shoulder belt strap is correctly routed from the seat belt guide on the vehicle to the shoulder belt guide on the child restraint system. The shoulder belt strap must be routed forwards and downwards from the seat belt guide.

▶ Always observe the child restraint system manufacturer's installation instructions.

When installing a child restraint system on the front passenger seat, observe the vehicle-specific information (→ page 51).

If a person is sitting on the front passenger seat: PASSENGER AIR BAG OFF may be lit continuously or be off, depending on the person's stature.

A person on the front passenger seat must always observe the following information:

- If the front passenger seat is occupied by an adult or a person with a stature corresponding to that of an adult, the PASSENGER AIR BAG OFF indicator lamp must be off. This indicates that the front passenger airbag is enabled.

If the PASSENGER AIR BAG OFF indicator lamp is lit continuously, an adult or person with a build corresponding to that of an adult should not use the front passenger seat.

- If the front passenger seat is occupied by a person of smaller stature (e.g. a teenager or small adult), the PASSENGER AIR BAG OFF indicator lamp either lights up continuously or remains off, depending on the result of the classification.
 - If the PASSENGER AIR BAG OFF indicator lamp is off: move the front passenger seat as far back as possible.
 - If the PASSENGER AIR BAG OFF indicator lamp is lit continuously: the person of smaller stature should not use the front passenger seat.

⚠ WARNING Risk of injury or death when the PASSENGER AIR BAG OFF indicator lamp is lit

If the PASSENGER AIR BAG OFF indicator lamp remains lit after the system self-test, the front passenger air bag is deactivated. It will not be deployed in the event of an accident. In this case, the front passenger air bag cannot perform its intended protective func-

tion, e.g. when a person is seated in the front passenger seat.

That person could, for example, come into contact with the vehicle interior, especially if the person is sitting too close to the cockpit.

If the front passenger seat is occupied, always ensure that:

- The classification of the person in the front passenger seat is correct and the front passenger air bag is enabled or deactivated in accordance with the person in the front passenger seat.
- The person is seated properly with a correctly fastened seat belt.
- The front passenger seat has been moved as far back as possible.

Be sure to also observe the following further related subjects:

- Child restraint system on the front passenger seat (→ page 51).

PRE-SAFE® system

PRE-SAFE® (anticipatory occupant protection)

PRE-SAFE® is able to detect certain critical driving situations and implement pre-emptive measures to protect the vehicle occupants.

PRE-SAFE® can implement the following measures independently of each other:

- Tightening the seat belts on the driver's seat and front passenger seat.
- Closing the side windows.
- **Vehicles with memory function:** Moving the front passenger seat to a more favorable seat position.
- PRE-SAFE® Sound: provided that the multimedia system is switched on, generates a brief noise signal to stimulate the innate protective mechanism of a person's hearing.

! **NOTE** Damage caused by objects in the footwell or behind the seat

The automatic adjustment of the seat position may result in damage to the seat and/or the object.

▶ Stow objects in a suitable place.

Reversing the PRE-SAFE® system measures

If an accident did not occur, the pre-emptive measures that were taken are reversed.

You will need to perform certain settings yourself.

▶ If the seat belt pre-tensioning is not reduced, move the seat backrest back slightly. The locking mechanism releases.

Safely transporting children in the vehicle

Always observe when children are traveling in the vehicle

i Also strictly observe the safety notes for the specific situation. In this way you can recog-

nize potential risks and avoid dangers if children are traveling in the vehicle (→ page 47).

Be diligent

Bear in mind that neglecting to secure a child in the child restraint system may have serious consequences. Always be diligent in securing a child carefully before every journey.

To improve protection for children younger than 12 years old or under 5 ft (1.50 m) in height, Mercedes-Benz recommends you observe the following information:

- Always secure the child in a child restraint system suitable for this Mercedes-Benz vehicle.
- The child restraint system must be appropriate to the age, weight and size of the child.
- The vehicle seat must be suitable for installing a child restraint system.

Generic term "child restraint system"

The generic term child restraint system is used in this Operator's Manual. A child restraint system is, for example:

- a baby car seat
- a rearward-facing child seat
- a forward-facing child seat
- a child booster seat with a backrest and seat belt guide

The child restraint system must be appropriate to the age, weight and size of the child.

Observing laws and legal requirements

Always observe the legal requirements when using a child restraint system in the vehicle.

Observing standards for child restraint systems

All child restraint systems must meet the following standards:

- U.S. Federal Motor Vehicle Safety Standards 213 and 225

- Canadian Motor Vehicle Safety Standards 213 and 210.2

Confirmation that the child restraint system complies with the standards can be found on an instruction label on the child restraint system. This confirmation can also be found in the installation instructions that are included with the child restraint system.

Detecting risks, avoiding danger

Securing systems for child restraint systems in the vehicle

Only use the following securing systems for child restraint systems:

- the vehicle's seat belt system

A booster seat may be necessary to achieve proper seat belt positioning for children over 40 lbs (18 kg) in weight or until they reach a height where a three-point seat belt can be installed properly without a booster seat.

Mercedes-Benz recommends a suitable child booster seat with a backrest and seat belt guide.

Advantage of a rearward-facing child restraint system

It is preferable to transport a baby or a small child in a suitable rearward-facing child restraint system. In this case, the child sits in the opposite direction to the direction of travel and faces backwards.

Babies and small children have comparatively weak neck muscles in relation to the size and weight of their head. The risk of injury to the cervical spine during an accident can be reduced in a rearward-facing child restraint system.

Always secure a child restraint system correctly

⚠ WARNING Risk of injury or death caused by incorrect installation of the child restraint system

If the child restraint system is incorrectly installed on a suitable seating position, it cannot perform its intended protective function.

The child cannot be restrained in the event of an accident, heavy braking or a sudden change of direction.

- ▶ Always comply with the manufacturer's installation instructions for the child restraint system and its correct use.
- ▶ Make sure that the entire base of the child restraint system always rests on the sitting surface of the seat.
- ▶ Never place objects under or behind the child restraint system, e.g. cushions.
- ▶ Always use child restraint systems with the original cover designed for them.
- ▶ Always replace damaged covers with genuine covers.

⚠ WARNING Risk of injury or death from unsecured child restraint systems in the vehicle

If the child restraint system is not correctly installed or secured, it could release in the

event of an accident, sudden braking or a sudden change in direction.

The child restraint system could be flung around and hit vehicle occupants.

- ▶ Always install child restraint systems correctly, even when not in use.
- ▶ Always comply with the child restraint system manufacturer's installation instructions.

- Always observe the child restraint system manufacturer's installation and operating instructions as well as the vehicle-specific information:
 - Secure the child restraint system with the seat belt on the front passenger seat (→ page 52). Observe the specific instructions for the rearward-facing and forward-facing child restraint systems (→ page 51).If the front passenger seat is occupied, ensure, both before and during the journey, that the status of the front

passenger airbag is correct for the current situation (→ page 43).

- Observe the warning labels in the vehicle interior and on the child restraint system.

Do not modify the child restraint system

⚠ WARNING Risk of injury due to modifications to the child restraint system

The child restraint system may no longer function as it is supposed to if you make modifications or attach objects to it, e.g. toys or unsuitable accessories. This poses an increased risk of injury!

Never modify the child restraint system. Only attach accessories which the manufacturer of the child restraint system has authorized especially for this child restraint system.

Only use child restraint systems which are in proper working condition

⚠ WARNING Risk of injury or death caused by the use of damaged child restraint systems

Child restraint systems or their retaining systems that have been subjected to a load in an accident may then not be able to perform their intended protective function.

The child cannot be restrained in the event of an accident, heavy braking or a sudden change of direction.

- ▶ Always replace child restraint systems immediately that have been damaged or involved in an accident.
- ▶ Have the securing systems for the child restraint systems checked at a qualified specialist workshop before installing a child restraint system again.

Avoid direct sunlight

▲ WARNING Risk of burns when the child seat is exposed to direct sunlight

If the child restraint system is exposed to direct sunlight or heat, parts could heat up. Children could suffer burns from these parts, particularly on metallic parts of the child restraint system.

- ▶ Always make sure that the child restraint system is not exposed to direct sunlight.
- ▶ Protect it with a blanket, for example.
- ▶ If the child restraint system has been exposed to direct sunlight, allow it to cool before securing a child into it.
- ▶ Never leave children unattended in the vehicle.

Observe when stopping or parking

▲ WARNING Risk of accident and injury due to children left unattended in the vehicle

If children are left unattended in the vehicle, they could:

- Open doors, thereby endangering other persons or road users.
- Get out and be struck by oncoming traffic.
- Operate vehicle equipment and become trapped, for example.

In addition, the children could also set the vehicle in motion, for example by:

- Releasing the parking brake.
 - Changing the transmission position.
 - Starting the vehicle.
- ▶ Never leave children unattended in the vehicle.

- ▶ When leaving the vehicle, always take the key with you and lock the vehicle.
- ▶ Keep the vehicle key out of reach of children.

▲ WARNING Risk of fatal injury due to exposure to extreme heat or cold in the vehicle

If people – particularly children – are exposed to extreme temperatures over an extended period of time, there is a risk of serious or even fatal injury.

- ▶ Never leave anyone – particularly children – unattended in the vehicle.
- ▶ Never leave animals in the vehicle unattended.

Overview of suitable seats in the vehicle for installing a child restraint system

Securing systems for child restraint systems

Vehicle seat		
Front passenger seat	Securing system: <ul style="list-style-type: none"> Vehicle seat belt . 	Be sure to observe: <ul style="list-style-type: none"> If the front passenger seat is occupied, ensure, both before and during the journey, that the status of the front passenger airbag is correct for the current situation (→ page 43). Notes on automatic front passenger airbag shut-off (→ page 41).

Activating/deactivating the seat belt's child special seat belt retractor

⚠ WARNING Risk of injury or death if a seat belt is unfastened while the vehicle is in motion

If the seat belt is released while the vehicle is in motion, the child restraint system is no longer correctly secured. The child seat safety feature is deactivated and the seat belt is drawn in a bit by the inertia reel.

It is therefore not possible to engage the seat belt again.

- ▶ Pull over and stop the vehicle safely as soon as possible, paying attention to road and traffic conditions.
- ▶ Activate the child seat safety feature again and correctly secure the child restraint system.

When enabled, the special seat belt retractor ensures that the seat belt of the front passenger seat does not slacken once the child restraint system is secured.

The seat belt on the front passenger side is equipped with a special seat belt retractor.

- ▶ **To install a child restraint system:** when installing a child restraint system, always observe the manufacturer's installation and operating instructions as well as the information in this Operator's Manual.

- ▶ Pull the seat belt smoothly from the seat belt outlet.
- ▶ Engage the seat belt tongue in the seat belt buckle.
- ▶ **To activate the special seat belt retractor:** pull the seat belt out fully and let the inertia reel retract it again. When the special seat belt retractor is activated, you should hear a ratcheting sound.
- ▶ Push the child restraint system down until the seat belt sits tightly.
- ▶ **To deactivate the special seat belt retractor:** press the release button of the seat belt buckle.
- ▶ Hold the seat belt tongue and guide back to the seat belt outlet.

Securing the child restraint system with the seat belt

Notes on rearward-facing and forward-facing child restraint systems on the front passenger seat

⚠ WARNING Risk of injury or death from using a rearward-facing child restraint system when the front passenger front airbag is enabled

If you secure a child in a rearward-facing child restraint system on the front passenger seat and the PASSENGER AIR BAG OFF indicator lamp is off, the front passenger airbag can deploy in the event of an accident.

The child could be struck by the airbag.

Always ensure that the front passenger airbag is deactivated. The PASSENGER AIR BAG OFF indicator lamp must be lit.

NEVER use a rearward-facing child restraint system on a seat protected by an ENABLED FRONT AIRBAG in front of it, DEATH or SERIOUS INJURY to the CHILD can occur.

Observe the specific instructions for the rearward-facing and forward-facing child restraint systems (→ page 52).

Always observe the status of the front passenger airbag on the PASSENGER AIR BAG OFF indicator lamp:

- When using a rearward-facing child restraint system on the front passenger seat, the front passenger airbag must always be disabled. This is only the case if the PASSENGER AIR BAG OFF indicator lamp is lit continuously (→ page 43).
- If the PASSENGER AIR BAG OFF indicator lamp is off, the front passenger airbag is enabled. The front passenger airbag may deploy during an accident.

Securing the child restraint system with the seat belt on the front passenger seat

When installing a belt-secured child restraint system on the front passenger seat, always observe the following:

- ✔ Observe the child restraint system manufacturer's installation and operating instructions.
- ✔ The backrest of the forward-facing child restraint system must lie as flat as possible against the backrest of the front-passenger seat.
- ✔ For certain child restraint systems in weight category II or III, there may be restrictions on the maximum size setting, e.g. due to possible contact with the roof.
- ✔ The child restraint system must not be tensioned between the roof and the seat cushion and/or be installed facing the wrong direction.
- ✔ The child restraint system must not be put under strain by the head restraints. Adjust the head restraints accordingly.

- ✔ Never place objects under or behind the child restraint system, e.g. cushions.

The seat belt on the front passenger side is equipped with a special seat belt retractor.

When enabled, the special seat belt retractor function ensures that the seat belt does not slacken once the child restraint system is secured (→ page 50).

- ▶ Set the front passenger seat as far back as possible and move the seat into the highest position if possible.
- ▶ Set the seat backrest to the most vertical position possible.
- ▶ Install the child restraint system. The entire base of the child restraint system must always rest on the seat cushion of the front-passenger seat.
- ▶ Always make sure that the shoulder belt strap is correctly routed from the seat belt

outlet of the vehicle to the shoulder belt guide on the child restraint system. The shoulder belt strap must be routed forwards and downwards from the seat belt outlet.

- ▶ If necessary, adjust the front passenger seat accordingly.

Notes on pets in the vehicle

⚠ WARNING Risk of accident and injury due to animals left unsecured or unattended in the vehicle

If you leave animals in the vehicle unattended or unsecured, they could possibly press down buttons or switches.

Thereby an animal may:

- activate vehicle equipment and become trapped, for example
- switch systems on or off and endanger other road users

Unsecured animals may be thrown around in the vehicle in the event of an accident or sudden steering and braking maneuver and injure vehicle occupants in the process.

- ▶ Never leave animals in the vehicle unattended.
- ▶ Always correctly secure animals while driving, for example using a suitable animal carrier.

SmartKey

Overview of SmartKey functions

⚠ WARNING Risk of accident and injury due to children left unattended in the vehicle

If children are left unattended in the vehicle, they could:

- Open doors, thereby endangering other persons or road users.
- Get out and be struck by oncoming traffic.
- Operate vehicle equipment and become trapped, for example.

In addition, the children could also set the vehicle in motion, for example by:

- Releasing the parking brake.
- Changing the transmission position.
- Starting the vehicle.

▶ Never leave children unattended in the vehicle.

- ▶ When leaving the vehicle, always take the key with you and lock the vehicle.
- ▶ Keep the vehicle key out of reach of children.

⚠ NOTE Damage to the key caused by magnetic fields

- ▶ Keep the key away from strong magnetic fields.

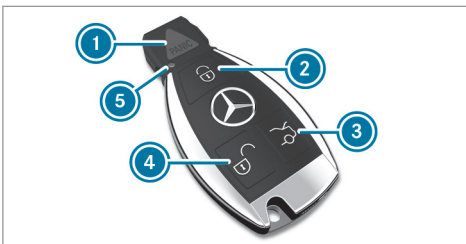

- ① Panic alarm
- ② Locks
- ③ Opens the trunk lid



- ④ Unlocks
- ⑤ Battery check lamp
- ⓘ The SmartKey may vary from the one shown in the diagram, depending on the vehicle equipment.

The SmartKey locks and unlocks the following components:

- the doors
- the trunk lid
- the fuel filler flap

If the vehicle is not opened within approximately 40 seconds after unlocking, it locks again. Anti-theft protection is armed again.

Do not keep the SmartKey together with electronic devices or metal objects. This can affect the SmartKey's functionality.

- ⓘ If battery check lamp ⑤ does not light up after pressing the  or  button, the battery has been discharged.

Change the SmartKey battery (→ page 56).

Activating/deactivating the acoustic locking verification signal

Multimedia system:

↳ Vehicle ▶▶  Vehicle Settings

▶▶ Acoustic Lock

▶ Activate or deactivate the function.

Activating/deactivating the panic alarm

Requirements:

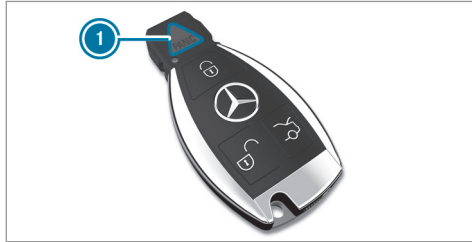

- The ignition is switched off.
- i The panic alarm function is only available in certain countries.



- ▶ **To activate:** press button 1 for approximately one second. A visual and audible alarm is triggered.
 - ▶ **To deactivate:** briefly press button 1 again.
- or
- ▶ Press the start/stop button on the cockpit (the SmartKey is inside the vehicle).

Changing the unlocking settings

Possible unlocking functions of the SmartKey:

- Central unlocking
- Unlocking the driver's door and fuel filler flap
- ▶ **To switch between settings:** press the  and  buttons simultaneously for approximately six seconds until the battery check lamp flashes twice.

Options if the unlocking function for the driver's door and fuel filler flap has been selected:

- Pressing the  button a second time centrally unlocks the vehicle
- **Vehicles with KEYLESS-GO:** if you touch the inner surface of the door handle on the

driver's door, only the driver's door and fuel filler flap are unlocked.

Deactivating the SmartKey functions

If you do not use the vehicle or a SmartKey for an extended period of time, you can reduce the energy consumption of the respective SmartKey. To do so, deactivate the SmartKey functions.

- ▶ **To deactivate:** press the  button on the SmartKey twice in quick succession. The battery check lamp of the SmartKey flashes twice briefly and lights up once.
- ▶ **To activate:** press any button on the SmartKey.
- i When the vehicle is started with the SmartKey in the marked space of the center console, the SmartKey functions are automatically activated (→ page 111).

Removing/inserting the emergency key

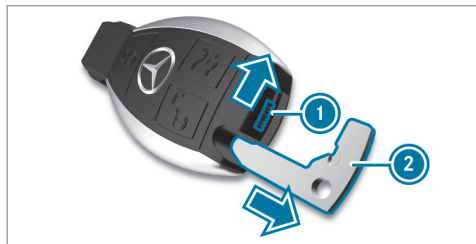

- ▶ **To remove:** push release catch ① in the direction of the arrow and simultaneously pull emergency key ② completely out of the SmartKey.
- ▶ **To insert:** push emergency key ② fully into the SmartKey until it engages. Release catch ① must then be back in the basic position.

Replacing the SmartKey battery

⚠ DANGER Serious damage to health caused by swallowing batteries

Batteries contain toxic and corrosive substances. Swallowing batteries may cause serious damage to health.

There is a risk of fatal injury.

- ▶ Keep batteries out of the reach of children.
- ▶ If batteries are swallowed, seek medical attention immediately.

🔥 ENVIRONMENTAL NOTE Environmental damage caused by improper disposal of batteries



Batteries contain pollutants. It is illegal to dispose of them with the household rubbish.



Dispose of batteries in an environmentally responsible manner. Take discharged batteries to a qualified specialist workshop or to a collection point for used batteries.

Requirements

- You require a CR 2025 3 V cell battery.

Mercedes-Benz recommends that you have the battery replaced at a qualified specialist workshop.

- ▶ Remove the emergency key (→ page 56).

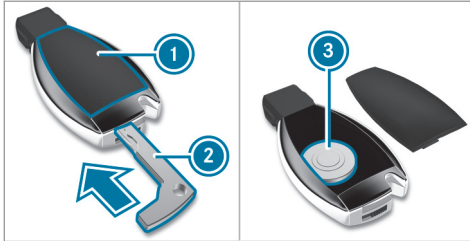

- ▶ Insert the front tabs of battery compartment cover ① into the housing and then press to close it.
- ▶ Insert emergency key ② into the SmartKey.

- ▶ Press emergency key ② into the opening in the SmartKey in the direction of the arrow until battery compartment cover ① opens. When doing so, do not hold battery compartment cover ① shut.
- ▶ Remove battery compartment cover ①.
- ▶ Repeatedly tap the SmartKey against your palm until battery ③ falls out of the SmartKey.
- ▶ Insert the new battery with the positive pole facing upwards. Use a lint-free cloth to do so.
- ▶ Make sure that the surface of the battery is free of lint, grease and other impurities.

Problems with the SmartKey

Problem	Possible causes/consequences and ► Solutions
You can no longer lock or unlock the vehicle.	<p>Possible causes are:</p> <ul style="list-style-type: none">• The SmartKey battery is discharged or nearly discharged.• There is interference from a powerful radio signal source.• The SmartKey is defective. <p>► Check the battery using the battery check lamp and replace if necessary (→ page 56).</p> <p>► Use the emergency key to lock or unlock (→ page 56).</p> <p>► Have the SmartKey checked at a qualified specialist workshop.</p>
You have lost a SmartKey.	<p>► Have the SmartKey deactivated at a qualified specialist workshop.</p> <p>► If necessary, have the mechanical lock changed as well.</p>

Doors

Unlocking and opening doors from the inside

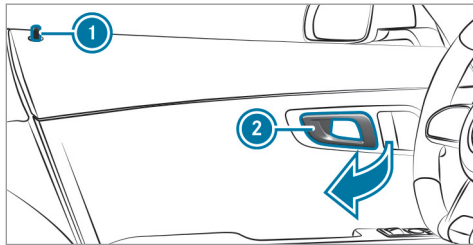

- ▶ Pull door handle (2).
Locking pin (1) pops up when the door is unlocked.

Centrally locking and unlocking the vehicle from the inside

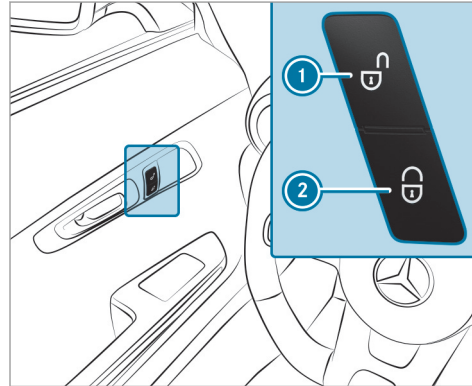

- ▶ **To unlock:** press button (1).
- ▶ **To lock:** press button (2).

This does not lock or unlock the fuel filler flap.

The vehicle is not unlocked:

- If you have locked the vehicle using the SmartKey.
- If you have locked the vehicle using KEY-LESS-GO.

Locking/unlocking the vehicle with KEY-LESS-GO

Requirements:

- The SmartKey is outside the vehicle.
- The distance between the SmartKey and the vehicle does not exceed 3 ft (1 m).
- The driver's door and the door at which the door handle is used are closed.

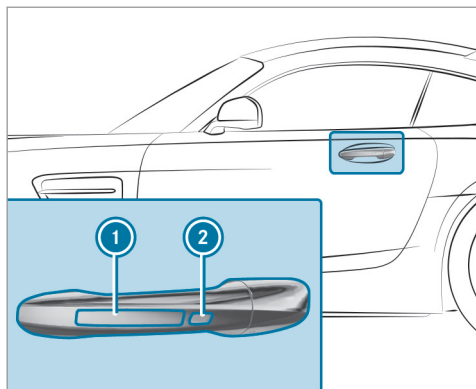

If you open the trunk lid from outside, the trunk lid is automatically unlocked.

- ▶ **To unlock the vehicle:** touch the inner surface of the door handle.
 - ▶ **To lock the vehicle:** touch sensor surface ① or ②.
 - ▶ **Convenience closing:** touch recessed sensor surface ② until the closing process has been completed.
- ① Further information on convenience closing (→ page 73).

Problems with KEYLESS-GO

Problem	Possible causes/consequences and ► Solutions
You can no longer lock or unlock the vehicle using KEYLESS-GO.	<p>Possible causes are:</p> <ul style="list-style-type: none">• The key functions have been deactivated (→ page 55).• The SmartKey battery is discharged or nearly discharged.• There is interference from a powerful radio signal source.• The SmartKey is faulty. <p>► Activate the SmartKey functions (→ page 55).</p> <p>► Check the battery using the battery check lamp and replace if necessary (→ page 56).</p> <p>► Use the emergency key to unlock or lock the vehicle (→ page 56).</p> <p>► Have the vehicle and SmartKey checked at a qualified specialist workshop.</p>

Activating/deactivating the automatic locking feature

The vehicle is locked automatically when the ignition is switched on and the wheels are turning faster than walking pace.

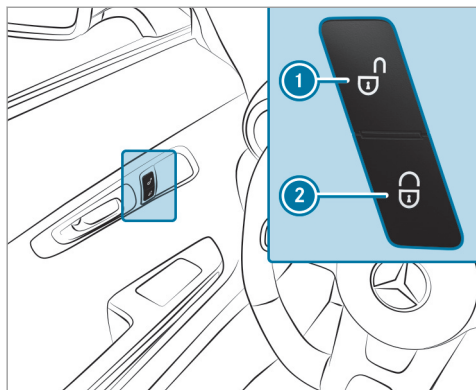

- ▶ **To activate:** press and hold button ② for approximately five seconds until an acoustic signal sounds.
- ▶ **To deactivate:** press and hold button ① for approximately five seconds until an acoustic signal sounds.

In the following situations, there is a danger of being locked out when the function is activated:

- While the vehicle is being tow started/ pushed.
- If the vehicle is being tested on a roller dynamometer.

Locking/unlocking the driver's door with the emergency key

- ① If you wish to lock the vehicle entirely using the emergency key, first press the button for locking from the inside while the driver's door is open. Then proceed to lock the driver's door using the emergency key.

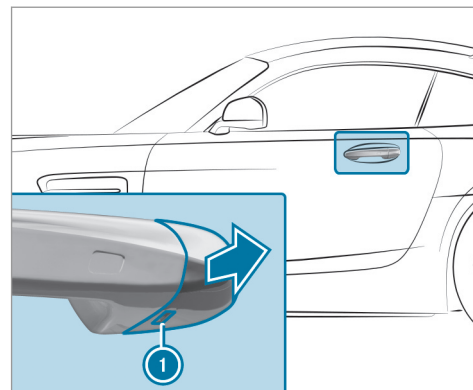

- ▶ Insert the emergency key as far as it will go into opening ① in the cover.
- ▶ Pull and hold the door handle.
- ▶ Pull the cover on the emergency key as straight as possible away from the vehicle until it releases.
- ▶ Release the door handle.

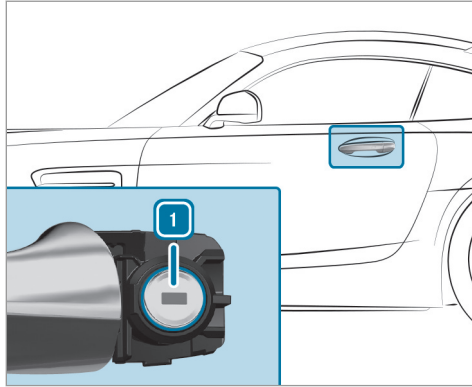

- ▶ **To unlock:** turn the emergency key counter-clockwise to position 1.
- ▶ **To lock:** turn the emergency key clockwise to position 1.
- ▶ Carefully press the cover onto the lock cylinder until it engages and is seated firmly.

Trunk

Opening the trunk lid

⚠ DANGER Risk of exhaust gas poisoning

Combustion engines emit poisonous exhaust gases such as carbon monoxide. Exhaust gases can enter the vehicle interior if the trunk lid is open when the engine is running, especially if the vehicle is in motion.

- ▶ Always switch off the engine before opening the trunk lid.
- ▶ Never drive with the trunk lid open.

⚠ NOTE Damage to the trunk lid by obstacles above the vehicle

The trunk lid swings upwards when it is opened.

- ▶ Therefore, make sure that there is sufficient clearance above the trunk lid.

You have the following options for opening the trunk lid:

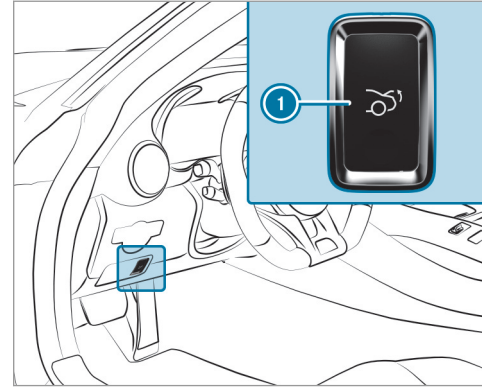

- ▶ Press the remote opening switch for trunk lid 1.
- ▶ Press the  button on the SmartKey. The trunk lid opens slightly.
- ▶ **Vehicles with HANDS-FREE ACCESS:** Make a kicking movement with your foot below the bumper (→ page 64).

Closing the trunk lid

⚠ WARNING Risk of injury from unsecured items in the vehicle

If objects, luggage or loads are not secured or not secured sufficiently, they could slip, tip over or be thrown around and thereby hit vehicle occupants.

There is a risk of injury, particularly in the event of sudden braking or a sudden change in direction.

- ▶ Always stow objects in such a way that they cannot be thrown around.
- ▶ Before the journey, secure objects, luggage or loads against slipping or tipping over.

Comply with the loading guidelines when you are loading the vehicle.

You have the following options for closing the trunk lid:

- ▶ Pull the trunk lid downwards using the handle recess and push it closed.

HANDS-FREE ACCESS function

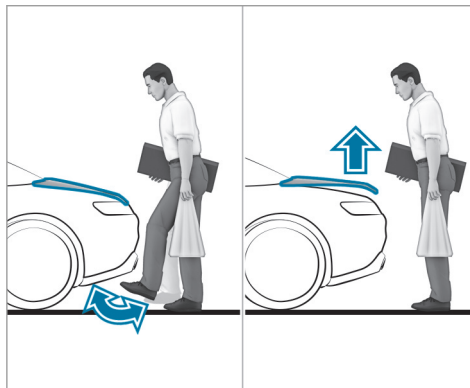

With HANDS-FREE ACCESS you can open the trunk lid by performing a kicking movement under the bumper.

Observe the notes when opening the trunk lid (→ page 63).

⚠ WARNING Risk of burns caused by a hot exhaust system

The vehicle exhaust system can become very hot. If you use HANDS-FREE ACCESS, you could burn yourself by touching the exhaust system.

- ▶ Always ensure that you only make a kicking movement within the detection range of the sensors.

! NOTE Damage to the vehicle caused by unintentionally opening the trunk lid

- When using an automatic car wash
- When using a high pressure cleaner
- ▶ Deactivate KEYLESS-GO or make sure that the SmartKey located is at least 10 ft (3 m) away from the vehicle in such situations.

When making the kicking movement, make sure that your feet are firmly on the ground, otherwise you could lose your balance, e.g. on ice.

Observe the following notes:

- The SmartKey is behind the vehicle.
- Stand at least 12 in (30 cm) away from the vehicle while performing the kicking movement.
- Do not come into contact with the bumper while making the kicking movement.
- Do not carry out the kicking movement too slowly.
- The kicking movement must be towards the vehicle and back again.

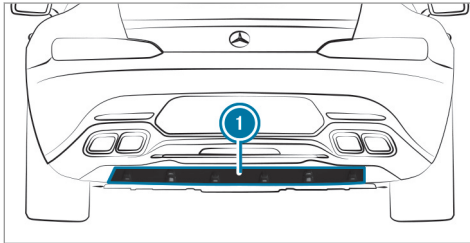

① Detection range of the sensors

If several consecutive kicking movements are not successful, wait ten seconds.

System limits

The system may be impaired or may not function in the following cases:

- The area around the sensor is dirty, e.g. due to road salt or snow.
- The kicking movement is made using a prosthetic leg.

The trunk lid could be opened unintentionally, in the following situations:

- If a person's arms or legs are moving in the sensor detection range, e.g. when polishing the vehicle or picking up objects.
- If objects are moved or placed behind the vehicle, e.g. tensioning straps or luggage.
- If clamping straps, tarps or other coverings are pulled over the bumper.
- If a protective mat with a length reaching over the trunk sill down into the detection range of the sensors is used.
- If the protective mat is not secured correctly.

Deactivate the key functions (→ page 55) or do not carry the SmartKey about your person in such situations.

Switching separate trunk locking on/off

If you centrally unlock the vehicle while separate locking is activated, the trunk will remain locked.

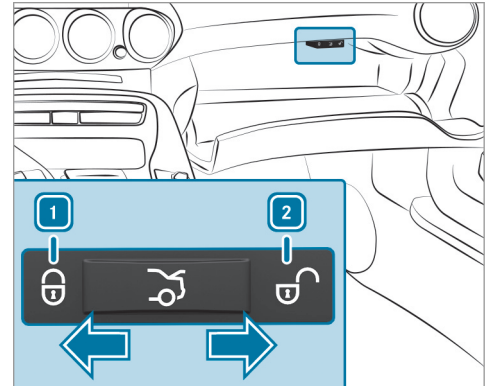

▶ **To switch on:** slide the switch to position **1**.

▶ **To switch off:** slide the switch to position **2**.

ⓘ If an accident has been detected, the trunk will unlock even if separate locking is switched on.

Unlocking the trunk from inside with the emergency release

Requirements:

- The 12 V vehicle battery is connected and charged.

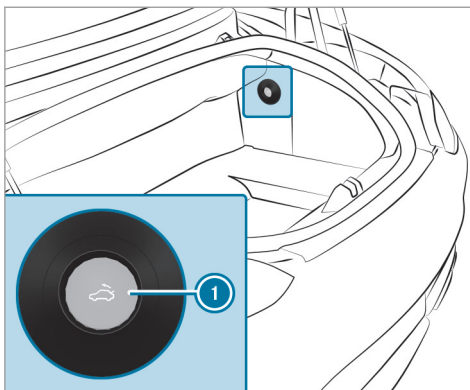

▶ Press emergency release button **1** briefly. The trunk lid unlocks and opens.

Soft top

Opening and closing the soft top using the soft-top switch

⚠ **WARNING** Risk of becoming trapped due to the soft top lowering unexpectedly

If you do not fully open/close the soft top, the soft-top hydraulics depressurize after a short time.

This causes the soft top to lower unexpectedly and may cause you or others to be trapped.

▶ Always fully open or close the soft top.

⚠ **WARNING** Risk of becoming trapped when opening/closing the soft top .

When opening or closing the soft top, there is a risk that parts of the body could become trapped by moving parts such as the roof mechanism, the trunk lid, or the side windows.

- ▶ When opening or closing, make sure that no body parts are in the vicinity of moving components.
- ▶ Release the button if somebody becomes trapped.

! **NOTE** Possible damage to the soft top when opening or closing

The soft top can be damaged when opening or closing.

- ▶ Make sure there is sufficient clearance above it.
- ▶ If the soft top is dirty, wet or frozen, do not open the soft top.
- ▶ If the outside temperature is below 15 °F (-10 °C), do not open the soft top.

! **NOTE** Damage to the soft top caused by heavy objects

Heavy objects placed on the soft-top compartment cover can damage the soft top or soft-top compartment cover.

- ▶ Do not place heavy objects on the soft-top compartment cover.
- ▶ Do not sit on the soft-top compartment cover.

For safety reasons, Mercedes-Benz recommends opening or closing the soft top when the vehicle is stationary.

To open or close the soft top while you are driving, do not exceed a maximum speed of 30 mph (50 km/h). To avoid interrupting the closing process while you are slightly exceeding this speed, do not drive at a speed greater than 37 mph (60 km/h).

- ▶ Make sure that the trunk partition is closed.
- ▶ Switch on the ignition.
- ▶ Keep the brake pedal depressed when the vehicle is stationary.

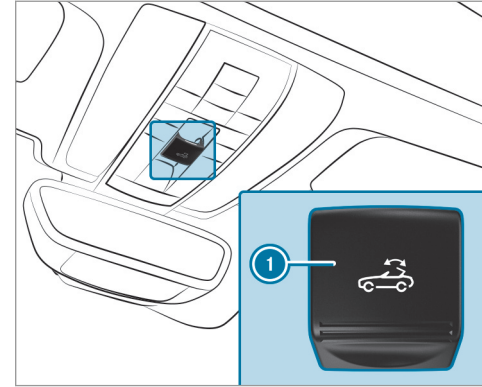

- ▶ **To open:** pull and hold soft-top switch ① until the soft top is fully open. The multifunction display shows the opening process of the soft top.
- ▶ **To close:** press and hold soft-top switch ① until the soft top is fully closed. The multifunction display shows the closing process of the soft top.

⚠ WARNING Risk of accident due to excessive speed during the soft-top opening or closing procedure

If the vehicle speed exceeds 37 mph (60 km/h), the soft top stops during the opening or closing procedure.

This impairs your view to the rear.

- ▶ Reduce the vehicle speed to below 37 mph (60 km/h) or stop the vehicle, paying attention to road and traffic conditions.
- ▶ Operate the soft-top switch again in order to open or close the soft top fully.

The current procedure is stopped at a speed greater than 37 mph (60 km/h). The **Open/Close Convertible Top Completely** message will be shown on the multifunction display.

- ▶ Reduce your speed and press or pull soft-top switch **1** again.

If the soft top does not close fully because of strong headwinds, drive more slowly or stop.

Relocking the soft top

⚠ WARNING Risk of becoming trapped due to the soft top lowering unexpectedly

If you do not fully open/close the soft top, the soft-top hydraulics depressurize after a short time.

This causes the soft top to lower unexpectedly and may cause you or others to be trapped.

- ▶ Always fully open or close the soft top.

If the soft top has not been completely locked, the multifunction display will show the **Open/Close Convertible Top Completely** message. In addition, you will hear a warning tone for up to ten seconds while driving.

- ▶ Pull over and stop the vehicle safely as soon as possible in accordance with the traffic conditions.
- ▶ Make sure that the ignition is switched on.
- ▶ Fully close the soft top using the soft-top switch.

Installing and removing the wind screen

⚠ WARNING Risk of accident and injury due to an incorrectly installed wind screen

If the wind screen is not correctly installed it can come loose during the journey and endanger other road users.

- ▶ Install the wind screen as described.
- ▶ Do not place objects on the installed wind screen.

! **NOTE** The wind screen can be damaged if installed when the soft top is closed

The vehicle interior or the wind screen can be damaged if installed when the soft top closed.

- ▶ To install, open the soft top.

Installing

The folding wind screen is installed between the roll bars to protect against wind when you are driving with the soft top open.

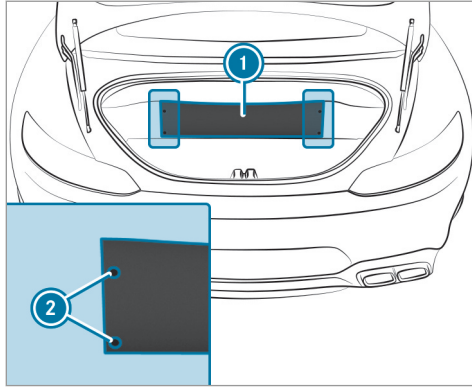

- ▶ Unfasten wind screen bag ① at four press studs ② on the trunk partition.
- ▶ Remove the wind screen from wind screen bag ①.

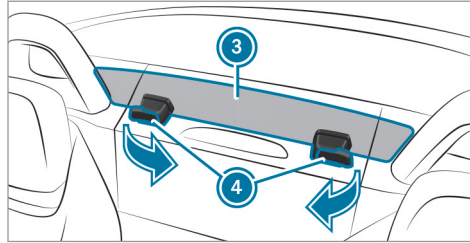

- ▶ Fold two locking levers ④ on wind screen ③ inwards in the direction of the arrow.
- ▶ Insert wind screen ③ in the slots between the roll bars until it locks in position.
- ▶ Fold two locking levers ④ on wind screen ③ outwards.

Removal

- ▶ Fold two locking levers ④ on wind screen ③ inwards in the direction of the arrow.
- ▶ Pull wind screen ③ up and out.
- ▶ Stow wind screen ③ in the wind screen bag and fasten this to the partition in the trunk.

Problems with the soft top

Problem	Possible causes/consequences and ► Solutions
The soft top will not open or close.	The ignition is not switched on. ► Make sure that the ignition is switched on.
	The brake pedal is not depressed with the vehicle stationary. ► Depress the brake pedal.
	The soft top mechanical components or control system are defective. ► Consult a qualified specialist workshop.
	The soft top has been opened and closed several times in a row. The soft top drive has been switched off automatically and will be available again after approximately ten minutes. ► Repeat the opening or closing procedure after approximately ten minutes.
	You are driving at a speed greater than 37 mph (60 km/h). ► Reduce your speed to below 37 mph (60 km/h).

Side windows

Opening and closing the side windows

⚠ WARNING Risk of entrapment when opening a side window

When opening a side window, parts of the body could be drawn in or become trapped between the side window and window frame.

- ▶ When opening, make sure that nobody is touching the side window.
- ▶ If someone is trapped, release the button immediately or pull it in order to close the side window again.

⚠ WARNING Risk of becoming trapped when closing a side window

When closing a side window, body parts could be trapped in the closing area in the process.

- ▶ When closing, make sure that no body parts are in the closing area.

- ▶ If someone is trapped, release the button immediately or press the button in order to reopen the side window.

⚠ WARNING Risk of becoming trapped when children operate the side windows

Children could become trapped if they operate the side windows, particularly when unattended.

- ▶ Never leave children unattended in the vehicle.
- ▶ When leaving the vehicle, always take the SmartKey with you and lock the vehicle.

Requirements:

- The power supply or the ignition is switched on.

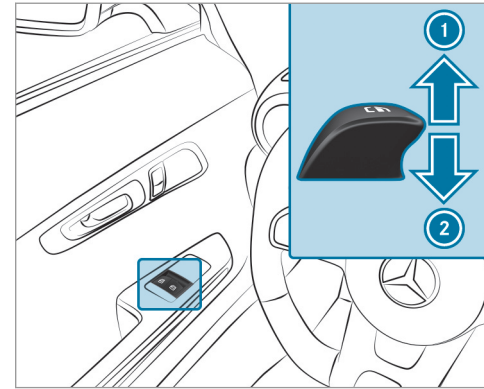

① Closes

② Opens

The buttons on the driver's door take precedence.

- ▶ **To start automatic operation:** press the  button beyond the point of resistance or pull and release it.

- ▶ **To interrupt automatic operation:** press or pull the  button again.

When the vehicle is switched off, the side windows can continue being operated.

Automatic reversing function of the side windows

If an object blocks a side window during the closing process, the side window opens again automatically. The automatic reversing function is only an aid and is not a substitute for your attentiveness.

- ▶ During the closing process, make sure that no body parts are in the closing area.

⚠ WARNING Risk of becoming trapped despite there being reversing protection on the side window

The reversing function does not react:

- To soft, light and thin objects, e.g. fingers
- During resetting

This means that the reverse function cannot prevent someone from becoming trapped in these situations.

- ▶ When closing, make sure that no body parts are in the closing area.
- ▶ If someone becomes trapped, press the  button to open the side window again.

Convenience opening (ventilating the vehicle before starting a journey)

⚠ WARNING Risk of entrapment when opening a side window

When opening a side window, parts of the body could be drawn in or become trapped between the side window and window frame.

- ▶ When opening, make sure that nobody is touching the side window.
- ▶ Release the button immediately if somebody becomes trapped.

⚠ WARNING Risk of becoming trapped when opening/closing the soft top .

When opening or closing the soft top, there is a risk that parts of the body could become trapped by moving parts such as the roof mechanism, the trunk lid, or the side windows.

- ▶ When opening or closing, make sure that no body parts are in the vicinity of moving components.
- ▶ Release the button if somebody becomes trapped.

- ▶ Press and hold the  button on the SmartKey.

The following functions are performed:

- The vehicle is unlocked
- The soft top is opened.
- The seat ventilation of the driver's seat is switched on.

- ▶ **To interrupt convenience opening:** release the  button.

- ▶ **To continue convenience opening:** press and hold the  button again.

Convenience closing (closing the vehicle from outside)

- ▲ **WARNING** Risk of entrapment caused by inadvertent convenience closing

When the convenience closing feature is operating, parts of the body could become trapped in the closing area of the side windows.

- ▶ Observe the complete closing procedure when using convenience closing.
- ▶ When closing, make sure that no body parts are in the closing area.

- ▲ **WARNING** Risk of becoming trapped when opening/closing the soft top .

When opening or closing the soft top, there is a risk that parts of the body could become

trapped by moving parts such as the roof mechanism, the trunk lid, or the side windows.

- ▶ When opening or closing, make sure that no body parts are in the vicinity of moving components.
- ▶ Release the button if somebody becomes trapped.

- ▶ Press and hold the  button on the SmartKey.

The following functions are performed:

- The vehicle is locked.
- The soft top is closed.

The side windows are closed when the soft top is closed.

- ▶ **To interrupt convenience closing:** release the  button.

- ① Convenience closing can also be operated with KEYLESS-GO (→ page 59).

Problems with the side windows

- ▲ **WARNING** Risk of becoming trapped or fatally injured if reversing protection is not activated

If you close a side window again immediately after it has been blocked, the side window will close with increased or maximum force. The reversing feature will then not be active.

Parts of the body could become trapped in the closing area in the process.

- ▶ Make sure that no parts of the body are in the closing area.
- ▶ To stop the closing process, release the button or press the button again to re-open the side window.

Problem	Possible causes/consequences and ► Solutions
A side window cannot be closed and you cannot see the cause.	<ul style="list-style-type: none">► Check to see whether any objects are in the window guide.► Adjust the side windows. <p>Adjusting the side windows</p> <p>If a side window is obstructed during closing and reopens again immediately:</p> <ul style="list-style-type: none">► Immediately after this, pull the corresponding button again until the side window has closed, and hold the button for at least one more second (re-adjustment). The side window is closed without the automatic reversing function. <p>If the side window is obstructed again and reopens again immediately:</p> <ul style="list-style-type: none">► Immediately after this, pull the corresponding button again until the side window has closed, and hold the button for at least one more second (follow-up adjustment). The side window is closed without the automatic reversing function.
The side windows cannot be opened or closed using the convenience opening feature.	<p>The SmartKey battery is discharged or nearly discharged.</p> <ul style="list-style-type: none">► Check the battery using the battery check lamp and replace if necessary (→ page 56).

Anti-theft protection

Function of the immobilizer

The immobilizer prevents your vehicle from being started without the correct SmartKey.

The immobilizer is automatically activated when the ignition is switched off and deactivated when the ignition is switched on.

When leaving the vehicle, always take the SmartKey with you and lock the vehicle. Anyone can start the engine if a valid SmartKey has been left inside the vehicle.

- i In the event the engine cannot be started (yet the vehicle's battery is charged), the system is not operational. Contact an authorized Mercedes-Benz Center or call 1-800-FOR-MERCEdes (in the USA) or 1-800-387-0100 (in Canada).

ATA (anti-theft alarm system)

Function of the ATA system

If the ATA system is armed, a visual and audible alarm is triggered in the following situations:

- when a door is opened
- when the trunk lid is opened
- when the hood is opened

The ATA system is armed automatically after approximately ten seconds in the following situations:

- after locking the vehicle with the SmartKey
- after locking the vehicle using KEYLESS-GO

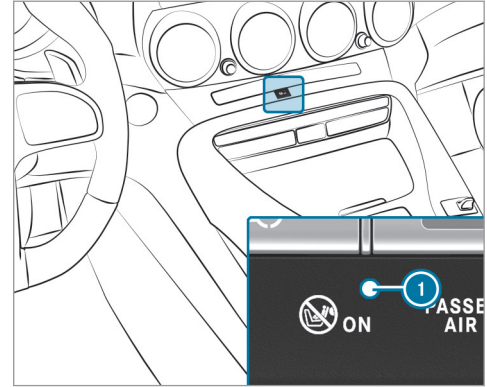

Indicator lamp ❶ flashes when the ATA system is armed.

The ATA system is deactivated automatically in the following situations:

- after unlocking the vehicle with the SmartKey
- after unlocking the vehicle using KEYLESS-GO

- after starting the vehicle with the SmartKey (→ page 111)
- ① When the Mercedes-Benz emergency call system is active and the alarm stays on for more than 30 seconds, a message is automatically sent to the Customer Assistance Center (→ page 266).
- ① In the case of severe battery discharging, the anti-theft alarm system is automatically deactivated to facilitate the next engine start.

Deactivating the ATA

▶ Press the ,  or  button on the SmartKey.

or

▶ Start the vehicle with the SmartKey (→ page 111).

Deactivating the alarm using KEYLESS-GO:

▶ Grasp the outside door handle with the SmartKey outside the vehicle.

Notes on the correct driver's seat position

⚠ WARNING Risk of injury from adjusting the vehicle settings while the vehicle is in motion

You could lose control of the vehicle in the following situations:

- if you adjust the driver's seat, the head restraint, the steering wheel or the mirror while the vehicle is in motion
 - if you fasten your seat belt while the vehicle is in motion
- ▶ Before starting the engine: adjust the driver's seat, the head restraint, the steering wheel or the mirror and fasten your seat belt.

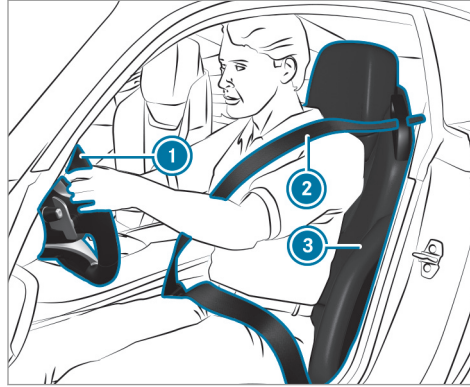

Ensure the following when adjusting steering wheel ①, seat belt ② and driver's seat ③:

- you are sitting as far away from the driver's airbag as possible
- you are sitting in an upright position
- your thighs are slightly supported by the seat cushion

- your legs are not fully extended and you can depress the pedals properly
- the back of your head is supported at eye level by the center of the head restraint
- you can hold the steering wheel with your arms slightly bent
- you can move your legs freely
- you can see all the displays on the instrument cluster clearly
- you have a good overview of the traffic conditions
- your seat belt sits snugly against your body and passes across the center of your shoulder and across your hips in the pelvic area

Seats**Adjusting the front seat mechanically**

⚠ WARNING Risk of becoming trapped if the seats are adjusted by children

Children could become trapped if they adjust the seats, particularly when unattended.

- ▶ When leaving the vehicle, always take the SmartKey with you and lock the vehicle.
- ▶ Never leave children unattended in the vehicle.

⚠ WARNING Risk of becoming trapped when adjusting the seats

When you adjust a seat, you or other vehicle occupants could become trapped, e.g. on the seat guide rail.

- ▶ When adjusting a seat, make sure that no one has any body parts in the sweep of the seat.

Observe the safety notes on "Airbags" and "Children in the vehicle".

⚠ WARNING Risk of accident due to the driver's seat not being engaged

If the driver's seat is not engaged, it could move unexpectedly while the vehicle is in motion.

This could cause you to lose control of the vehicle.

- ▶ Always make sure that the driver's seat is engaged before starting the vehicle.

⚠ WARNING Risk of injury from adjusting the vehicle settings while the vehicle is in motion

You could lose control of the vehicle in the following situations:

- if you adjust the driver's seat, the head restraint, the steering wheel or the mirror while the vehicle is in motion
- if you fasten your seat belt while the vehicle is in motion
- ▶ Before starting the engine: adjust the driver's seat, the head restraint, the steering wheel or the mirror and fasten your seat belt.

⚠ WARNING Risk of becoming trapped if the seat height is adjusted carelessly

If you adjust the seat height carelessly, you or other vehicle occupants could be trapped and thereby injured.

Children in particular could accidentally press the electrical seat adjustment buttons and become trapped.

- ▶ While moving the seats, make sure that hands or other body parts do not get under the lever assembly of the seat adjustment system.

⚠ WARNING Risk of injury due to head restraints which are not installed or are adjusted incorrectly

If head restraints are not installed or are adjusted incorrectly, the head restraints cannot provide protection as intended.

There is an increased risk of injury in the head and neck area, e.g. in the event of an accident or when braking.

- ▶ Always drive with the head restraints installed.
- ▶ Before driving off, make sure for every vehicle occupant that the center of the head restraint supports the back of the head at about eye level.

⚠ WARNING Risk of injury or death due to incorrect seat position

The seat belt does not offer the intended level of protection if you have not moved the seat backrest to an almost vertical position.

When braking or in the event of an accident, you could slide underneath the seat belt and sustain abdominal or neck injuries, for example.

- ▶ Adjust the seat properly before beginning your journey.
- ▶ Always ensure that the seat backrest is in an almost vertical position and that the shoulder section of your seat belt is routed across the center of your shoulder.

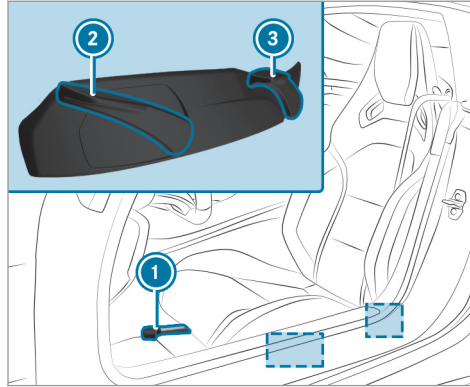

- ▶ **To adjust the seat fore-and-aft position:** lift lever ① and slide the seat into the desired position.
- ▶ Make sure that the seat is engaged.
- ▶ **To adjust the seat height:** push or pull lever ② until the desired position has been reached.

- ▶ **To adjust the seat backrest inclination:** lift lever ③ and set the seat to the desired angle.
- ▶ Ensure that the seat backrest is engaged.

Adjusting the front seat electrically

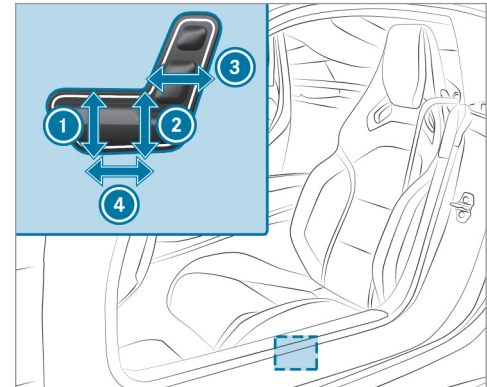

- ① Seat cushion inclination
- ② Seat height

- ③ Seat backrest inclination
- ④ Seat fore-and-aft position
- ▶ Save the settings with the memory function (→ page 87).

Adjusting the 4-way lumbar support

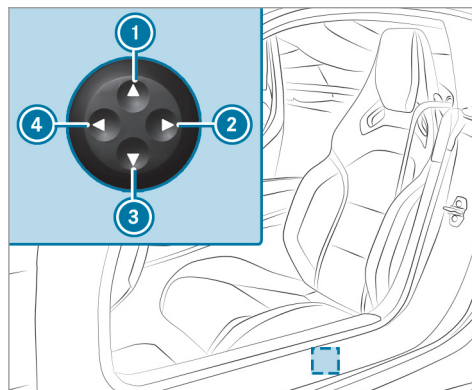

- ① Raise
- ② Soften
- ③ Lower
- ④ Harden

▶ Using buttons ① to ④, adjust the contour of the backrest individually to suit your back.

Adjusting the AMG Performance seat

To adjust the contour of the seat and for improved lateral support, you can adjust the front seats individually.

On the front passenger seat, you can adjust only the seat side bolsters of the seat backrest.

The AMG Performance seat is designed for the standard three-point seat belt. If you install a different multipoint seat belt, e.g. a sport or racing seat belt, the restraint system cannot provide the intended level of protection.

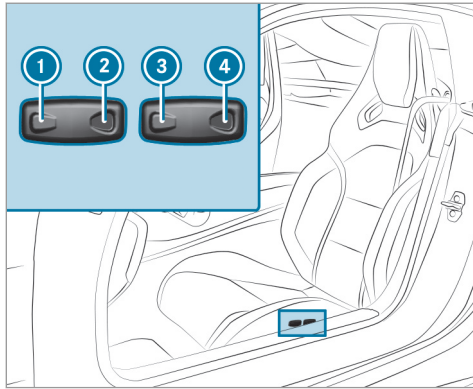

- ▶ **To adjust the seat side bolsters of the seat cushion:** press button ① (narrower) or ② (wider).
- ▶ **To adjust the seat side bolsters of the seat backrest:** press button ③ (narrower) or ④ (wider).

Head restraints

Adjusting the head restraints

⚠ WARNING Risk of injury from adjusting the vehicle settings while the vehicle is in motion

You could lose control of the vehicle in the following situations:

- if you adjust the driver's seat, the head restraint, the steering wheel or the mirror while the vehicle is in motion
- if you fasten your seat belt while the vehicle is in motion
- ▶ Before starting the engine: adjust the driver's seat, the head restraint, the steering wheel or the mirror and fasten your seat belt.

⚠ WARNING Risk of injury due to head restraints which are not installed or are adjusted incorrectly

If head restraints are not installed or are adjusted incorrectly, the head restraints cannot provide protection as intended.

There is an increased risk of injury in the head and neck area, e.g. in the event of an accident or when braking.

- ▶ Always drive with the head restraints installed.
- ▶ Before driving off, make sure for every vehicle occupant that the center of the head restraint supports the back of the head at about eye level.

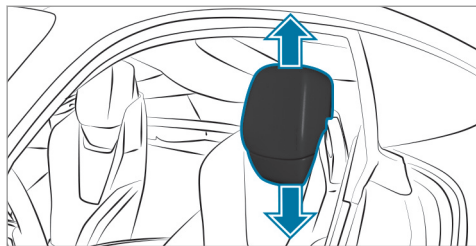

- ▶ **To raise:** pull the head restraint up.
- ▶ **To lower:** push the head restraint down.

Switching the seat heating on/off

⚠ WARNING Risk of burns due to repeatedly switching on the seat heating

Repeatedly switching on the seat heating can cause the seat cushion and seat backrest padding to become very hot.

The health of persons with limited temperature sensitivity or a limited ability to react to

high temperatures may be affected or they may even suffer burn-like injuries.

- ▶ Do not repeatedly switch on the seat heating.

To protect against overheating, the seat heating may be temporarily deactivated after it is switched on repeatedly.

! NOTE Damage to the seats caused by objects or documents when the seat heating is switched on

When the seat heating is switched on, overheating may occur due to objects or documents placed on the seats, e.g. seat cushions or child seats. This could cause damage to the seat surface.

- ▶ Make sure that no objects or documents are on the seats when the seat heating is switched on.

Requirements:

- The power supply is switched on.

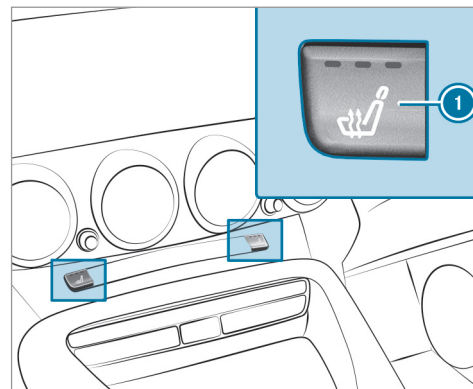

- ▶ **To switch on/increase the level:** press button ① repeatedly until the desired heating level is set. Depending on the heating level, up to three indicator lamps will light up.

- ▶ **To switch off/reduce the level:** press button ❶ repeatedly until the desired heating level is set.
If all indicator lamps are off, the seat heating is switched off.

- ❶ The seat heating will automatically switch down from the three heating levels after 5, 10 and 20 minutes until the seat heating switches off.

Switching the seat ventilation on/off

Requirements:

- The power supply is switched on.

The seat ventilation is available only for vehicles with AMG Performance seats.

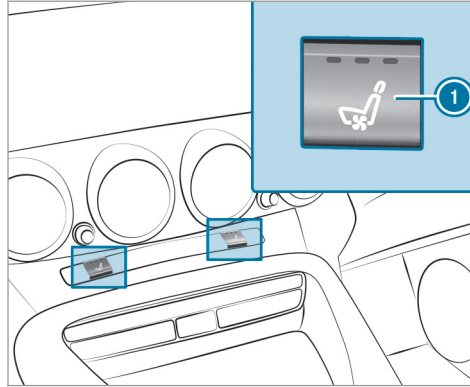

- ▶ **To switch on/increase the level:** press button ❶ repeatedly until the desired ventilation level is set.
Depending on the ventilation level, up to three indicator lamps will light up.

- ▶ **To switch off/reduce the level:** press button ❶ repeatedly until the desired ventilation level is set.
If all indicator lamps are off, the seat ventilation is switched off.

Switching AIRSCARF on/off

- ⚠ **WARNING** Risk of burns caused by the heating output from AIRSCARF being too high

When AIRSCARF is switched on, very hot air can flow from the outlet opening in the head restraints.

This could result in burns in the immediate vicinity of the outlet opening.

- ▶ Turn the heating output down in good time.
- ▶ Maintain a suitable distance from the outlet opening.

Requirements:

- The power supply is switched on.

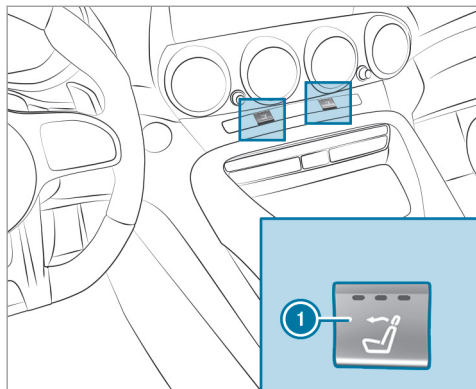

AIRSCARF warms the head and neck area of vehicle occupants with warm air. The warm air flows out of the vents in the head restraints.

- ▶ **To switch on/increase the level:** press button ① repeatedly until the desired heating level is set. Depending on the heating level, up to three indicator lamps will light up.

- ▶ **To switch off/reduce the level:** press button ① repeatedly until the desired heating level is set. If all the indicator lamps are off, AIRSCARF is switched off.
- ① When switching on, the blower will start up only after a preheating phase lasting a few seconds. After switching off, the blower will continue to run for a few seconds to cool down the heating elements.
- ① If the vehicle battery voltage is too low, AIRSCARF may switch off.
- ▶ Adjust the AIRSCARF vent (→ page 108).

Make sure that there are no objects covering the intake grille on the back of the head restraint.

Make sure that objects do not enter the vents in the head restraints.

Steering wheel

Adjusting the steering wheel mechanically

- ⚠ **WARNING** Risk of injury from adjusting the vehicle settings while the vehicle is in motion

You could lose control of the vehicle in the following situations:

- if you adjust the driver's seat, the head restraint, the steering wheel or the mirror while the vehicle is in motion
- if you fasten your seat belt while the vehicle is in motion

- ▶ Before starting the engine: adjust the driver's seat, the head restraint, the steering wheel or the mirror and fasten your seat belt.

- ⚠ **WARNING** Risk of becoming trapped if the seats are adjusted by children

Children could become trapped if they adjust the seats, particularly when unattended.

- ▶ When leaving the vehicle, always take the SmartKey with you and lock the vehicle.
- ▶ Never leave children unattended in the vehicle.

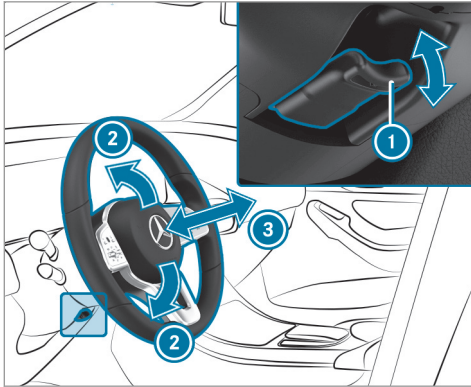

- ▶ Push release lever ① down as far as it will go. The steering column is unlocked.

- ▶ Adjust height ② and distance ③ to the steering wheel.
- ▶ Push release lever ① up as far as it will go. The steering column is locked.
- ▶ Check and make sure that the steering column is locked by moving the steering wheel.

Adjusting the steering wheel electrically

The steering wheel can be adjusted when the power supply is switched off.

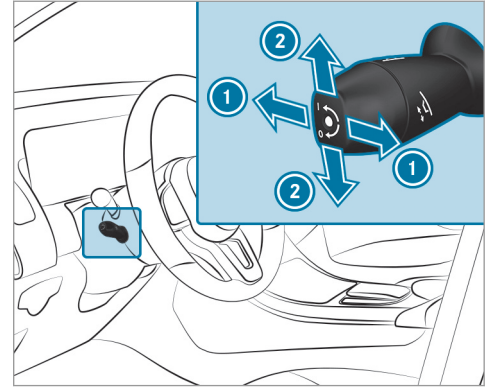

- ① Adjusts the distance to the steering wheel
- ② Adjusts the height
- ▶ Save the settings with the memory function (→ page 87).

Easy entry and exit feature

Using the easy entry and exit feature

⚠ WARNING Risk of accident when driving off while adjusting the easy exit feature

- If you drive off while the easy entry and exit feature is making adjustments, you could lose control of the vehicle.

- ▶ Always wait until the adjustment process is complete before driving off.

⚠ WARNING Risk of becoming trapped while adjusting the easy entry and exit feature

When the easy entry and exit feature adjusts the steering wheel, you and other vehicle occupants – particularly children – could become trapped.

- ▶ During the adjustment process of the easy entry and exit feature, make sure that no one has any body parts in the sweep of the steering wheel.

- ▶ Move the adjustment lever of the steering wheel if there is a risk of becoming trapped by the steering wheel. The adjustment process is stopped.

⚠ WARNING Risk of becoming trapped during activation of the easy entry and exit feature by children

If children activate the easy entry and exit feature, they can become trapped, particularly when unattended.

- ▶ Never leave children unattended in the vehicle.
- ▶ When leaving the vehicle, always take the SmartKey with you and lock the vehicle.

Vehicles with memory function: you can stop the adjustment process by pressing one of the memory function position switches.

If the easy entry and exit feature is active, the steering wheel will move upwards or towards the dashboard when:

- you switch the ignition off.
- you open the driver's door.

i The steering wheel will move upwards and towards the dashboard only if it has not already reached the steering limitation.

The steering wheel will move back to the last drive position when:

- you close the driver's door with the ignition switched on.
- you press the start/stop button once.

The last drive position will be stored when:

- you switch the ignition off.
- you save the setting with the memory function.

If you press one of the memory function position switches, the adjustment process will be stopped.

Setting the easy entry and exit feature

Multimedia system:

↳ Vehicle ▶  Vehicle Settings
 ▶▶ Easy Entry/Exit

▶ Activate or deactivate the function.

Operating the memory function

⚠ WARNING Risk of an accident if the memory function is used while driving

If you use the memory function on the driver's side while driving, you could lose control of the vehicle as a result of the adjustments being made.

▶ Only use the memory function on the driver's side when the vehicle is stationary.

⚠ WARNING Risk of entrapment when setting the seat with the memory function

When the memory function adjusts the seat or steering wheel, you and other vehicle occupants – particularly children – could become trapped.

- ▶ During the setting procedure of the memory function, ensure that no body parts are in the sweep of the seat or the steering wheel.
- ▶ If somebody becomes trapped, immediately release the memory function position button.
The adjustment process is stopped.

⚠ WARNING Risk of entrapment if the memory function is activated by children

Children could become trapped if they activate the memory function, particularly when unattended.

- ▶ Never leave children unattended in the vehicle.

▶ When leaving the vehicle, always take the SmartKey with you and lock the vehicle.

The memory function can be used when the ignition is switched off.

Storing

Seat adjustments for up to three people can be stored and called up using the memory function.

The following systems can be selected:

- Seat and backrest
- Driver's side: steering wheel
- Driver's side: outside mirrors on the driver's and front passenger sides

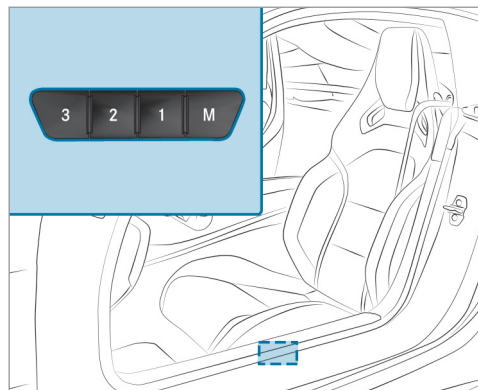

- ▶ Set the seat, the steering wheel and the outside mirrors to the desired position.
- ▶ Press memory button M together with one of preset position buttons 1, 2 or 3. An acoustic signal sounds. The settings are stored.
- ▶ **To call up:** press and hold the relevant preset position button 1, 2 or 3 until the front

seat, steering wheel and outside mirrors are in the stored position.

Stowage areas

Notes on loading the vehicle

⚠ DANGER Risk of exhaust gas poisoning

Combustion engines emit poisonous exhaust gases such as carbon monoxide. Exhaust gases can enter the vehicle interior if the trunk lid is open when the engine is running, especially if the vehicle is in motion.

- ▶ Always switch off the engine before opening the trunk lid.
- ▶ Never drive with the trunk lid open.

⚠ WARNING Risk of injury from unsecured items in the vehicle

If objects, luggage or loads are not secured or not secured sufficiently, they could slip, tip over or be thrown around and thereby hit vehicle occupants.

There is a risk of injury, particularly in the event of sudden braking or a sudden change in direction.

- ▶ Always stow objects in such a way that they cannot be thrown around.
- ▶ Before the journey, secure objects, luggage or loads against slipping or tipping over.

⚠ WARNING Risk of injury due to objects being stowed incorrectly

If you do not adequately stow objects in the vehicle interior, they could slip or be tossed around and thereby strike vehicle occupants. In addition, cup holders, open stowage spaces and mobile phone brackets cannot always restrain the objects they contain in the event of an accident.

There is a risk of injury, particularly in the event of sudden braking or a sudden change in direction.

- ▶ Always stow objects in such a way that they cannot be tossed about in these or similar situations.
- ▶ Always make sure that objects do not project from stowage spaces, parcel nets or stowage nets.
- ▶ Close the lockable stowage spaces before starting a journey.
- ▶ Always stow and secure objects that are heavy, hard, pointed, sharp-edged, fragile or too large in the trunk.

⚠ WARNING Risk of burning from the tailpipe or tailpipe trim

The tailpipe and tailpipe trim can become very hot. If you come into contact with these car parts, you could burn yourself.

- ▶ Always be particularly careful when in the vicinity of the tailpipe and tailpipe trims and supervise children very closely when in this area.
- ▶ Before any contact, allow the car parts to cool down.

The driving characteristics of your vehicle are dependent on the distribution of the load within the vehicle. You should bear the following in mind when loading the vehicle:

- never exceed the permissible gross mass or the gross axle weight rating for the vehicle (including occupants). The values are specified on the vehicle identification plate on the vehicle's B-pillar.
- position heavy loads as far forwards as possible and as low down in the trunk as possible.
- the load must not protrude above the upper edge of the seat backrests.
- always place the load behind unoccupied seats if possible.
- secure the load with sufficiently tear-resistant and wear-resistant tie downs. Pad sharp edges for protection.

Stowage spaces in the vehicle interior

Overview of the front stowage compartments

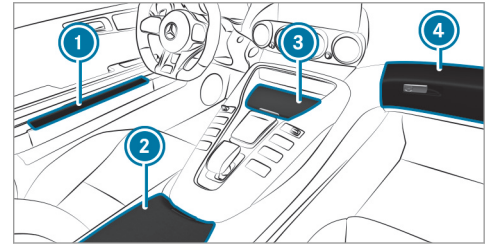

- ① Stowage compartment in the doors
- ② Stowage compartment beneath the armrest with multimedia connection unit with an SD card slot, two USB connections and the ignition lock
Depending on the equipment, there is a 12 V socket in the stowage compartment
- ③ Stowage compartment in the front center console with a USB connection
- ④ Glove box

Locking/unlocking the glove box

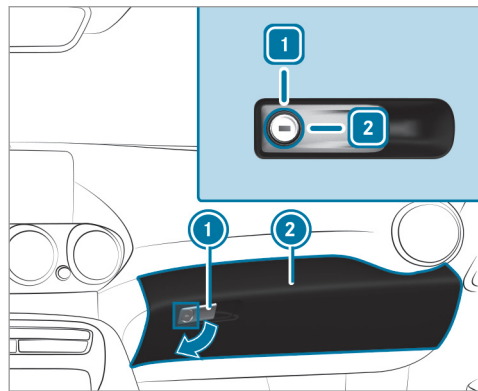

- ▶ Turn the emergency key a quarter turn clockwise **2** (to lock) or counter-clockwise **1** (to unlock).

Cup holder

Installing the cup holder in or removing it from the center console

- ⚠ **WARNING** - Risk of accident or injury when using the cup holder while the vehicle is moving

The cup holder cannot secure containers while the vehicle is moving.

If you use a cup holder while the vehicle is moving, the container may be flung around and liquids may be spilled. The vehicle occupants may come into contact with the liquid and if it is hot, they could be scalded. You could be distracted from traffic conditions and you may lose control of the vehicle.

- ▶ Only use the cup holder when the vehicle is stationary.
- ▶ Only use the cup holder for containers of the right size.
- ▶ Close the container, particularly if the liquid is hot.

- ⚠ **WARNING** Risk of injury due to objects being stowed incorrectly

If you do not adequately stow objects in the vehicle interior, they could slip or be tossed around and thereby strike vehicle occupants. In addition, cup holders, open stowage spaces and mobile phone brackets cannot always restrain the objects they contain in the event of an accident.

There is a risk of injury, particularly in the event of sudden braking or a sudden change in direction.

- ▶ Always stow objects in such a way that they cannot be tossed about in these or similar situations.
- ▶ Always make sure that objects do not project from stowage spaces, parcel nets or stowage nets.
- ▶ Close the lockable stowage spaces before starting a journey.
- ▶ Always stow and secure objects that are heavy, hard, pointed, sharp-edged, fragile or too large in the trunk.

Observe the notes on loading the vehicle.

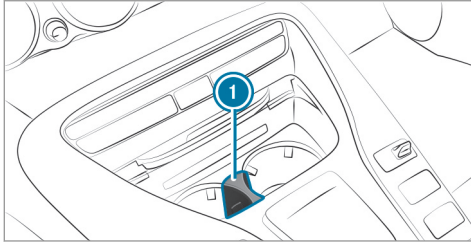

The divider in cup holder ① can be removed, e.g. to enable use with smaller drinks cans.

- ▶ **To remove:** pull the divider up and remove it.
- ▶ **To install:** re-insert the divider and push it down until it engages.

Ashtray and cigarette lighter

Using the ashtray

! **NOTE** Damage to the stowage compartment under the ashtray due to intense heat

The stowage compartment under the ashtray is not heat resistant and could be damaged if you rest a lit cigarette on it.

- ▶ Make sure that the ashtray is fully engaged.

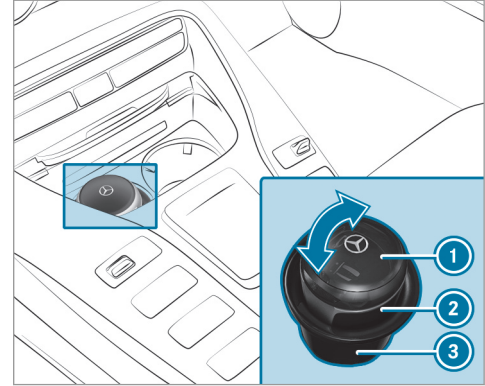

- ▶ Insert holder ③ into the cup holder on the left or right-hand side.
- ▶ **To open:** fold lid ① upwards.
- ▶ **To close:** press lid ① downwards.
- ▶ **To remove:** pull ashtray ② up and out of holder ③.
- ▶ **To insert:** place ashtray ② into holder ③.

- ① Remove holder ③ to be able to use the entire cup holder. Store holder ③ and ash-tray ② in a suitable place. Comply with the loading guidelines (→ page 88).

Using the cigarette lighter in the front center console

⚠ WARNING - Risk of fire and injury from hot cigarette lighter

You can burn yourself if you touch the hot heating element or the socket of the cigarette lighter.

In addition, flammable materials may ignite if:

- you drop the hot cigarette lighter
 - a child holds the hot cigarette lighter to objects, for example
- ▶ Always hold the cigarette lighter by the knob.
 - ▶ Always make sure that the cigarette lighter is out of reach of children.

▶ Never leave children unattended in the vehicle.

Requirements:

- The ignition is switched on.

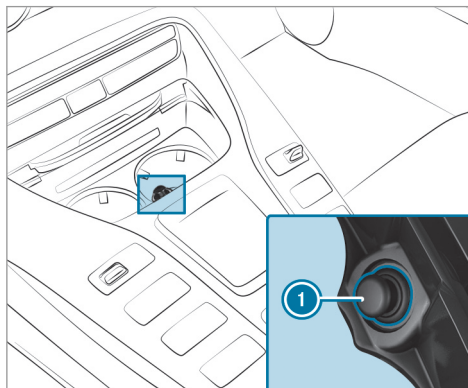

- ▶ Press in cigarette lighter ①. The cigarette lighter will pop out automatically when the heating element is red-hot.

Sockets

Using the 12 V socket under the armrest

Requirements:

- Only connect devices up to a maximum of 180 watts (15 A).

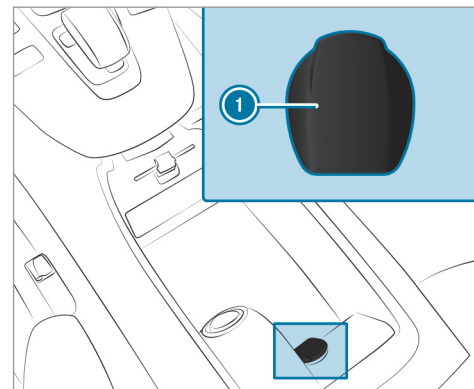

- ▶ Lift up socket cap ①.
- ▶ Insert the plug of the device.

The 12 V socket is only available on vehicles with an ashtray and a cigarette lighter in the stowage compartment under the armrest.

Using the 12 V socket in the trunk

Requirements:

- Only connect devices up to a maximum of 180 W (15 A).

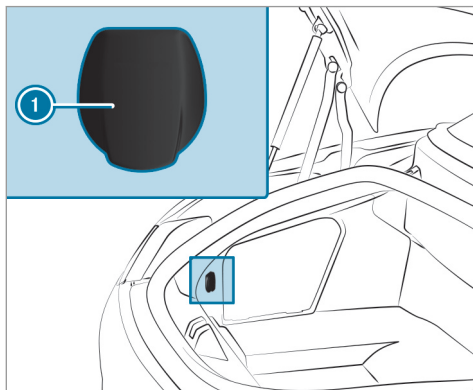

- ▶ Lift up cap ① of the socket and insert the plug of the device.

Installing/removing the floor mats

⚠ WARNING Risk of accident due to objects in the driver's footwell

Objects in the driver's footwell may impede pedal travel or block a depressed pedal.

This jeopardizes the operating and road safety of the vehicle.

- ▶ Stow all objects in the vehicle securely so that they cannot get into the driver's footwell.
- ▶ Always install the floor mats securely and as prescribed in order to ensure that there is always sufficient room for the pedals.
- ▶ Do not use loose floor mats and do not place floor mats on top of one another.

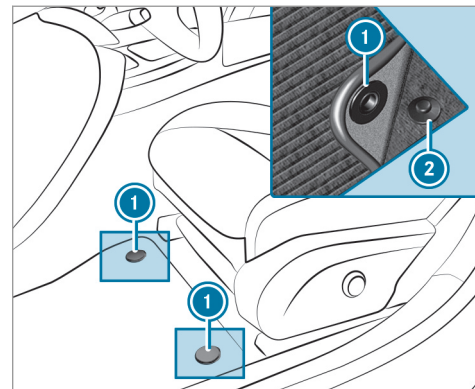

- ▶ **To install:** slide the corresponding seat backwards and lay the floor mat in the footwell.
- ▶ Press press-studs ① onto holders ②.
- ▶ Adjust the corresponding seat.
- ▶ **To remove:** slide the corresponding seat backwards and pull the floor mat off holders ②.

94 Seats and stowing

- ▶ Remove the floor mat.

Exterior lighting

Information about lighting systems and your responsibility

The various lighting systems of the vehicle are only aids. The driver of the vehicle is responsible for correct vehicle illumination in accordance with the prevailing light and visibility conditions, legal requirements and traffic situation.

Light switch

Operating the light switch

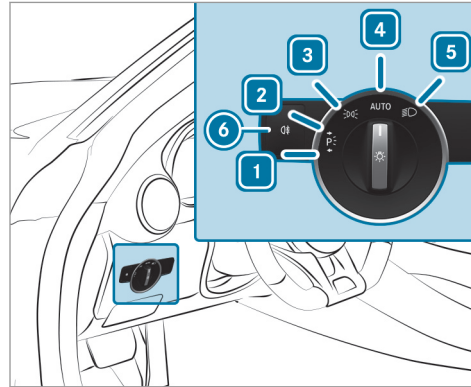

- 1 Left standing light
- 2 Right standing light
- 3 Parking lights and license plate lamp
- 4 **AUTO** Automatic driving lights (preferred light switch position)

- 5 Low beam/high beam
- 6 Switches the rear fog light on or off

When low beam is activated, the indicator lamp for the parking lights is deactivated and replaced by the low beam indicator lamp.

- ▶ Always park your vehicle safely using sufficient lighting, in accordance with the relevant legal stipulations.

! **NOTE** Battery discharging by operating the standing lights

Operating the standing lights over a period of hours puts a strain on the battery.

- ▶ Where possible, switch on the right or left parking light.

In the case of severe battery discharging, the standing lights or parking lights are automatically switched off to facilitate the next engine start.

The exterior lighting (except standing and parking lights) switches off automatically when the driver's door is opened.

- Observe the notes on surround lighting (→ page 99).

Automatic driving lights function

The parking lights, low beam and daytime running lamps are switched on automatically depending on the ignition status and the ambient light.

⚠ WARNING Risk of accident when the low beam is switched off in poor visibility

When the light switch is set to **AUTO**, the low beam may not be switched on automatically if there is fog, snow or other causes of poor visibility such as spray.

- ▶ In such cases, turn the light switch to .

The automatic driving lights are only an aid. You are responsible for vehicle lighting.

Switching the rear fog lights on or off

Requirements:

- The light switch is in the  or **AUTO** position.

- ▶ Press the  button.

Please observe the country-specific laws on the use of rear fog lamps.



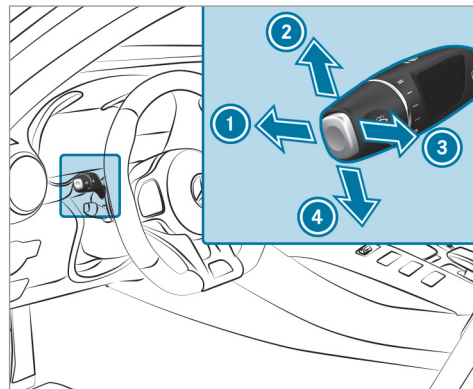

Operating the combination switch for the lights



- ① High-beam headlamps
- ② Turn signal indicator, right
- ③ High-beam flasher
- ④ Turn signal indicator, left

- ▶ Use the combination switch to activate the desired function.



High-beam headlamps



- ▶ **To switch on:** turn the light switch to the  or **AUTO** position.
- ▶ Press the combination switch beyond the point of resistance in the direction of arrow . When the high beam is activated, the  indicator lamp for low beam is deactivated and replaced by the  indicator lamp for the high beam.
- ▶ **To switch off:** move the combination switch back to its starting position.

High-beam flasher

- ▶ Pull the combination switch in the direction of arrow .

Turn signal lights

- ▶ **To indicate briefly:** press the combination switch briefly to the point of resistance in the direction of arrow  or . The corresponding turn signal indicator will flash three times.

- ▶ **To indicate permanently:** press the combination switch beyond the point of resistance in the direction of arrow  or .

Activating/deactivating the hazard warning lamps

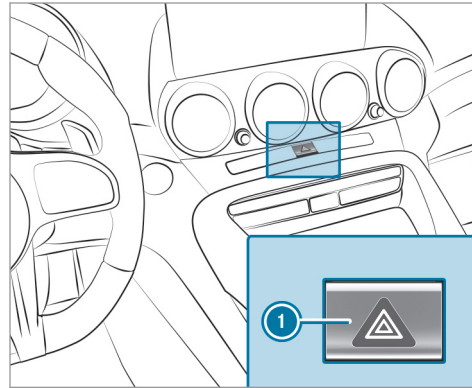

- ▶ Press button .

The hazard warning lamps will switch on automatically if:

- the airbag has been deployed.

Adaptive Highbeam Assist

Adaptive Highbeam Assist function

⚠ WARNING Risk of accident despite Adaptive Highbeam Assist

Adaptive Highbeam Assist does not recognize the following road users:

- Road users without lights, e.g. pedestrians
- Road users with poor lighting, e.g. cyclists
- Road users whose lighting is obstructed, e.g. by a barrier

On very rare occasions, Adaptive Highbeam Assist may fail to recognize other road users with their own lighting, or may recognize them too late.

In these or similar situations, the automatic high beam is not deactivated or is activated despite the presence of other road users.

- ▶ Always observe the traffic carefully and switch off the high beam in good time.

Adaptive Highbeam Assist cannot take into account road, weather or traffic conditions.

Detection may be restricted in the following cases:

- In poor visibility, e.g. fog, heavy rain or snow
- If there is dirt on the sensors or the sensors are obscured

Adaptive Highbeam Assist is only an aid. You are responsible for adjusting the vehicle's lighting to the prevailing light, visibility and traffic conditions.

- ⓘ Adaptive Highbeam Assist is available only in vehicles with LED high performance headlamps.

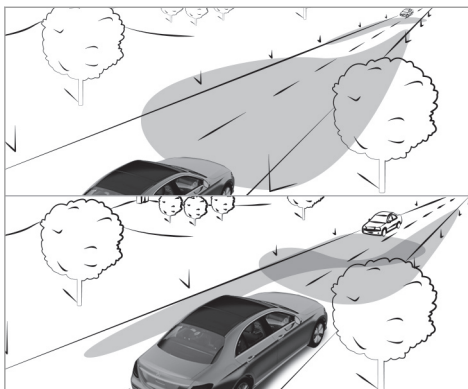

The Adaptive Highbeam Assist automatically switches between the following types of light:

- Low-beam headlamps
- High-beam headlamps

At speeds greater than 19 mph (30 km/h):

- If no other road users are detected, the high beam will be switched on automatically.

The high beam switches off automatically in the following cases:

- At speeds below 16 mph (25 km/h).
- If other road users are detected.
- If street lighting is sufficient.

At speeds greater than approximately 31 mph (50 km/h):

- The headlamp range of the low beam is regulated automatically based on the distance to other road users.

The system's optical sensor is located behind the windshield near the overhead control panel.

Switching Adaptive Highbeam Assist on/off

- ▶ **To switch on:** turn the light switch to the **AUTO** position.
- ▶ Switch on the high beam using the combination switch. When the high beam is switched on automatically in the dark, the  indicator lamp on the multifunction display comes on.
- ▶ **To switch off:** switch off the high beam using the combination switch.

Setting the exterior lighting switch-off delay time

Multimedia system:

- Vehicle ➤  Light Settings
- Ext. Light Switch Off
- ▶ Set the switch-off delay time.

Setting the surround lighting

Multimedia system:





- Vehicle ➤  Light Settings
- Locator Lighting
- ▶ Activate or deactivate the function.

If the surround lighting is switched on, the exterior lighting remains lit for 40 seconds after the vehicle is unlocked. When you start the vehicle, the surround lighting is deactivated and the automatic driving lights are activated.

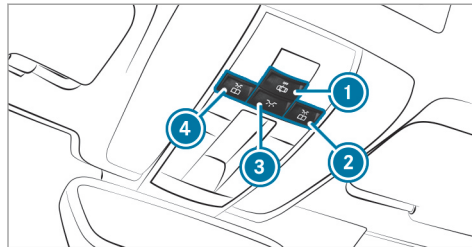
Interior lighting

Adjusting the interior lighting



- ①  Automatic interior lighting control
- ②  Right reading lamp
- ③  Interior lighting
- ④  Left reading lamp

▶ **To switch on or off:** press button ① - ④ accordingly.

Setting the interior lighting switch-off delay time

Multimedia system:

- Vehicle ➤  Light Settings
- Int. Light Switch Off
- ▶ Set the switch-off delay time.

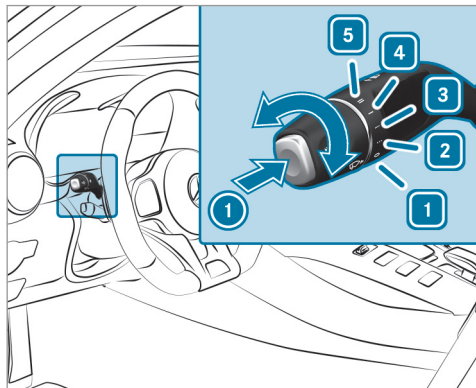

Windshield wiper and windshield washer system

Switching the windshield wipers on/off



- 1 0 Windshield wipers off
- 2 ... Intermittent wiping, normal
- 3 ... Intermittent wiping, frequent

- 4 — Continuous wiping, slow
- 5 == Continuous wiping, fast

- ▶ Turn the combination switch to the correct position 1 - 5.
- ▶ **Single wipe/washing:** push the button on the combination switch in the direction of arrow 1.
 -  Single wipe
 -  Wipes with washer fluid

Changing the windshield wiper blades

⚠ WARNING Risk of becoming trapped if the windshield wipers are switched on while wiper blades are being replaced

If the windshield wipers begin to move while you are changing the wiper blades, you can be trapped by the wiper arm.

- ▶ Always switch off the windshield wipers and the ignition before changing the wiper blades.

Moving the wiper arms to the change position

- ▶ Switch the ignition on and switch off again immediately.
- ▶ Within around 15 seconds, press the  button on the combination switch for approximately three seconds (→ page 100). The wiper arms will move into the change position.

Removing the wiper blades

- ▶ Fold the wiper arms away from the windshield.

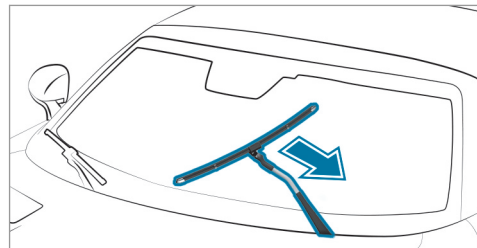

- ▶ Set the wiper blade at an angle.
- ▶ Pull the wiper blade out of the holder on the wiper arm in the direction of the arrow.

Installing the wiper blades

- ▶ Push the new wiper blade into the holder on the wiper arm against the direction of the arrow.
- ▶ Turn the wiper blade parallel to the wiper arm.
- ▶ Fold the wiper arm onto the windshield.

Mirrors

Operating the outside mirrors

⚠ WARNING Risk of injury from adjusting the vehicle settings while the vehicle is in motion

You could lose control of the vehicle in the following situations:

- if you adjust the driver's seat, the head restraint, the steering wheel or the mirror while the vehicle is in motion
 - if you fasten your seat belt while the vehicle is in motion
- ▶ Before starting the engine: adjust the driver's seat, the head restraint, the steering wheel or the mirror and fasten your seat belt.

⚠ WARNING Risk of accident due to misjudgment of distances when using the passenger mirror

The outside mirror on the front-passenger side reflects objects on a smaller scale. The objects in view are in fact closer than they appear.

As a result, you may misjudge the distance between you and the road user driving behind you, for example, when changing lanes.

- ▶ Therefore, always look over your shoulder in order to ensure that you are aware of the actual distance between you and the road users driving behind you.

Folding the outside mirrors in/out

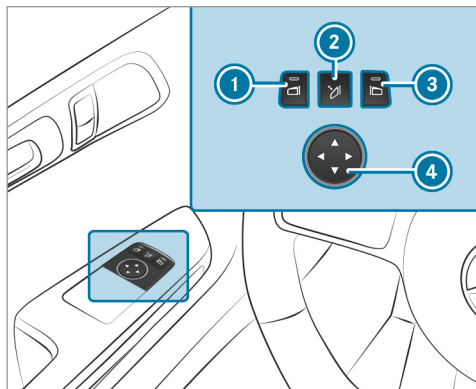

- ▶ Briefly press button ②.

Resetting the outside mirrors

- ① If the battery has been disconnected or completely discharged, the outside mirrors must be reset. Only then will the automatic mirror folding function work properly.
- ▶ Briefly press button ②.

Adjusting the outside mirrors

- ▶ Press button ① or ③ to select the outside mirror to be adjusted.
- ▶ Press button ④ to adjust the position of the mirror glass.

Engaging the outside mirrors

- ▶ **Vehicles without electrically folding outside mirrors:** manually move the outside mirror into the correct position.
- ▶ **Vehicles with electrically folding outside mirrors:** press and hold button ②. You will hear a click and the mirror will audibly engage in position. The outside mirror will now be set to the correct position.

Automatic anti-glare mirrors function

⚠ WARNING Risk of acid burns and poisoning due to the anti-glare mirror electrolyte

Electrolyte may escape if the glass in an automatic anti-glare mirror breaks.

The electrolyte is hazardous to health and causes irritation. It must not come into contact with your skin, eyes, respiratory organs or clothing or be swallowed.

- ▶ If you come into contact with electrolyte, observe the following:
 - Immediately rinse the electrolyte from your skin with water and seek medical attention.
 - If electrolyte comes into contact with your eyes, immediately rinse them thoroughly with clean water and seek medical attention.
 - If the electrolyte is swallowed, immediately rinse your mouth out thoroughly. Do not induce vomiting. Seek medical attention immediately.
 - Immediately change out of clothing which has been contaminated with electrolyte.
 - If an allergic reaction occurs, seek medical attention immediately.

The inside rearview mirror and the outside mirror on the driver's side will automatically go into anti-glare mode if light from a headlamp hits the sensor on the inside rearview mirror.

System limits

The system will not go into anti-glare mode if:

- The engine is switched off.
- Reverse gear is engaged.
- The interior lighting is switched on.

Front-passenger outside mirror parking position function

The parking position makes parking easier.

In the following situations, the front-passenger outside mirror will swivel downwards in the direction of the rear wheel on the front passenger's side:

- The parking position is stored (→ page 103)
- The front-passenger mirror is selected
- Reverse gear is engaged

The front-passenger outside mirror will move back to its original position in the following situations:

- You shift the transmission to another transmission position
- You are traveling at speeds greater than 9 mph (15 km/h)
- You press the button for the outside mirror on the driver's side

Storing the parking position of the front-passenger outside mirror using reverse gear

Storing

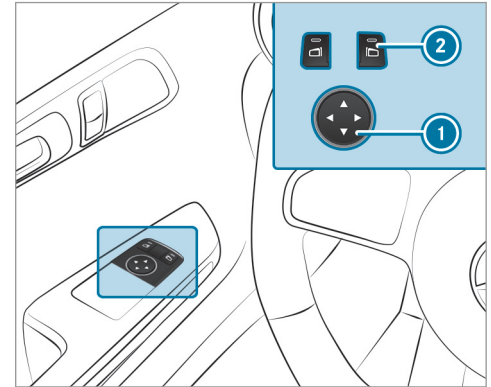

- ▶ Select the front-passenger outside mirror using button ②.
- ▶ Engage reverse gear.
- ▶ Move the front-passenger outside mirror into the desired parking position using button ①.

Calling up

- ▶ Select the front-passenger outside mirror using button ②.
- ▶ Engage reverse gear.
The front-passenger outside mirror will move to the stored parking position.

Activating/deactivating the automatic mirror folding function

Multimedia system:

↳ Vehicle ▶▶  Vehicle Settings

▶▶ Autom. Mirror Folding

- ▶ Activate or deactivate the function.

Operating the sun visors

Using the single sun visor

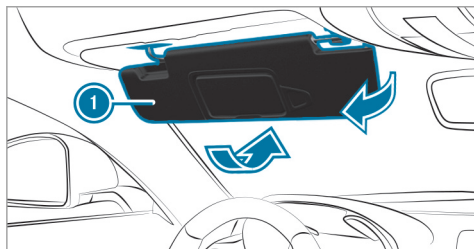

- ▶ **Glare from the front:** fold sun visor ① down.
- ▶ **Glare from the side:** swing sun visor ① to the side.

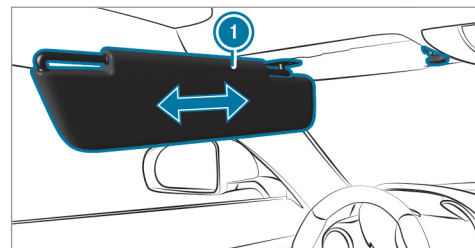

- ▶ Vehicles with an extendable sun visor: slide sun visor ① horizontally as required.

Overview of climate control systems





Notes on climate control

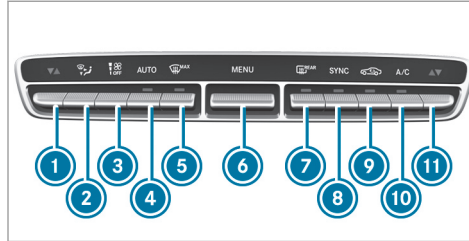

An interior air filter in combination with the pre-filter in the engine compartment must always be used so that the air conditioning system, pollution level monitoring and the air filtration work correctly. Make sure that the filter is installed correctly and the filter housing in the engine compartment is closed correctly using the cap and always tightly sealed when in operation. Use filters recommended and approved by Mercedes-Benz. Always have service work carried out at a qualified specialist workshop.

Overview of the control panel for 3-zone automatic climate control

The indicator lamps in the **AUTO**, **MAX**, **REAR**, , **A/C** and **SYNC** buttons indicate that the corresponding function is activated.





- ①  Sets the temperature on the driver's side
- ②  Sets the air distribution
- ③  Sets the airflow
Switches climate control on/off
- ④ **AUTO** Sets climate control to automatic mode (→ page 106)
- ⑤  Defrosts the windshield
- ⑥ **MENU** Calls up the air conditioning menu
- ⑦  Switches the rear window heater on or off
- ⑧ **SYNC** Activates or deactivates synchronization (→ page 106)

- ⑨  Switches air-recirculation mode on/off (→ page 107)
- ⑩ **A/C** Switches the A/C function on/off (→ page 105)
- ⑪  Sets the front passenger side temperature

Operating the climate control system

Switching climate control on/off

- ▶ **To switch on:** set the airflow to level 1 or higher using the  button.
 - ▶ **To switch off:** set the airflow to level 0 using the  button.
- ⓘ If climate control is switched off, the windows may fog up more quickly. Switch off climate control only briefly.

Switching the A/C function on or off via the control panel

The A/C function heats, cools and dehumidifies the vehicle's interior air.



- ▶ Press the  button.

Switch off the A/C function only briefly otherwise the windows may fog up more quickly.

Condensation may drip from the underside of the vehicle when cooling mode is active. This is not a sign that there is a malfunction.

Setting climate control to automatic mode

In automatic mode, the set temperature is controlled and maintained at a constant level by the air supply.

- ▶ Press the  button.
- ▶ **To switch to manual mode:** press the  or  button.

Climate style

Climate style function

In automatic mode, you can select the following climate style settings for the driver's and front passenger areas:

- **FOCUS:** high airflow, slightly cooler setting



- **MEDIUM:** medium airflow, standard setting
- **DIFFUSE:** low airflow, slightly warmer and draft-free setting

Adjusting the climate mode settings

Multimedia system:







- ▶  Vehicle ▶  Climate Control
- ▶▶ Climate Mode

- ▶ Select **FOCUS**, **MEDIUM** or **DIFFUSE**.

 To feel the effect of the climate style, the  function must be active (→ page 106).

Overview of the air distribution settings

The symbols on the display indicate which vents the airflow is being directed through:

-  defroster vents
-  Center and side air vents
-  Footwell vents
-  Center, side and footwell vents
-  Defroster and footwell vents
-  All vents

-  Defroster, middle and side air vents

Activating/deactivating the climate control synchronization function via the control panel



Climate control can be set centrally using the synchronization function. The temperature and air distribution setting for the driver side is adopted automatically for the front passenger side.

- ▶ Press the  button.

The synchronization function is deactivated if the settings for one of the other climate zones are changed.

Removing condensation from the windows

Windows fogged up on the inside

- ▶ Press the  button.
- ▶ Press the  button.
- ▶ If the windows continue to fog up: press the  button.

Windows fogged up on the outside

- ▶ Switch on the windshield wipers.
- ▶ Press the **AUTO** button.

Switching air-recirculation mode on/off

- ▶ Press the  button.
The interior air will be recirculated.

Air-recirculation mode automatically switches to fresh air mode after some time.

- ⓘ If air-recirculation mode is switched on, the windows may fog up more quickly. Switch on air-recirculation mode only briefly.

Air vents

Setting the air vents

⚠ WARNING - Danger of burns or frostbite due to being too close to the air vents

Very hot or very cold air can flow from the air vents.

This could result in burns or frostbite in the immediate vicinity of the air vents.

- ▶ Make sure that all vehicle occupants always maintain a sufficient distance to the air vents.
- ▶ If necessary, direct the airflow to another area of the vehicle interior.

To guarantee the flow of fresh air through the air vents into the vehicle interior, comply with the following:

- Always keep the vents and the ventilation grille in the vehicle interior free.
- Keep the air inlet free of deposits (→ page 302).

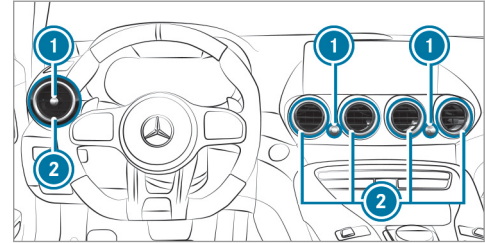

- ▶ **To open or close:** turn controller ① to the left or right.
- ▶ **To adjust the air direction (center air vent):** hold air vent ② by the slats in the center and move it up or down or to the left or right.

To adjust the air direction of side air vent, hold controller ① and move it up or down or to the left or right.

Adjusting the AIRSCARF vents

⚠ WARNING Risk of burns caused by the heating output from AIRSCARF being too high

When AIRSCARF is switched on, very hot air can flow from the outlet opening in the head restraints.

This could result in burns in the immediate vicinity of the outlet opening.

- ▶ Turn the heating output down in good time.
- ▶ Maintain a suitable distance from the outlet opening.

ⓘ NOTE Damage caused to AIRSCARF by the use of protective covers

If a protective cover is placed over the front seat head restraints, the flow of air from the AIRSCARF vent is hindered.

This can cause AIRSCARF to overheat and be damaged.

- ▶ Do not use protective covers on head restraints with AIRSCARF.

Make sure that there are no objects covering the intake grille on the back of the head restraint.

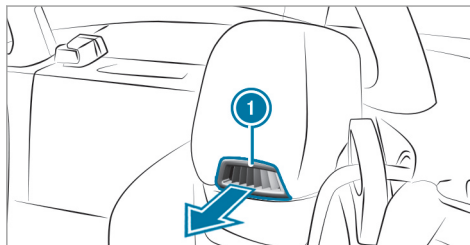

- ▶ You can adjust the blower output of AIRSCARF vents ① using the AIRSCARF button (→ page 83).

Driving

Switching the power supply or ignition on without starting the engine

⚠ WARNING Risk of accident and injury due to children left unattended in the vehicle

If children are left unattended in the vehicle, they could:

- Open doors, thereby endangering other persons or road users.
- Get out and be struck by oncoming traffic.
- Operate vehicle equipment and become trapped, for example.

In addition, the children could also set the vehicle in motion, for example by:

- Releasing the parking brake.
- Changing the transmission position.
- Starting the vehicle.

- ▶ Never leave children unattended in the vehicle.
- ▶ When leaving the vehicle, always take the key with you and lock the vehicle.
- ▶ Keep the vehicle key out of reach of children.

Also observe the "Notes on pets in the vehicle".

Requirements:

- The SmartKey is located in the vehicle and the SmartKey battery is not discharged.
- The brake pedal is not depressed.

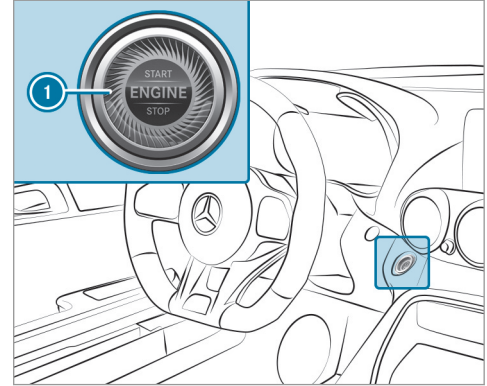

- ▶ **To switch on the power supply:** press button ① once. You can activate the windshield wipers, for example.

The power supply is switched off again if the following conditions are met:

- You open the driver's door.
- You press button ① twice more.

- ▶ **To switch on the ignition:** press button ① twice.
The indicator lamps in the instrument cluster light up.

The ignition is switched off again if one of the following conditions is met:

- You do not start the vehicle within 15 minutes.
 - The transmission is in position **P** or the electric parking brake has been applied.
 - You press button ① once.
- ① You can also switch on the power supply or the ignition with the SmartKey in the ignition lock (→ page 111).

Starting the vehicle

Starting the vehicle with the start/stop button

Requirements

- the SmartKey is located in the vehicle and the SmartKey battery is not discharged.

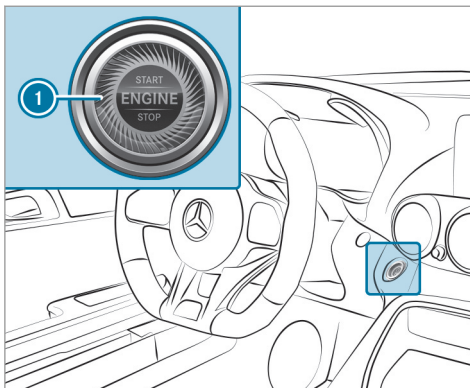

- ▶ Shift the transmission to position **P** or **N**.
- ▶ Depress the brake pedal and press button ① once.
- ▶ If the vehicle does not start: switch off non-essential consumers and press button ① once.
- ▶ If the vehicle still does not start and the **Key Not Detected** display message also appears

in the multifunction display: start the vehicle with the SmartKey (→ page 111).

- ① You can switch off the engine while driving by pressing button ① for about three seconds or by pressing button ① three times within three seconds. Be sure to observe the safety notes under "Driving tips" (→ page 112).

Function of Emotion Start

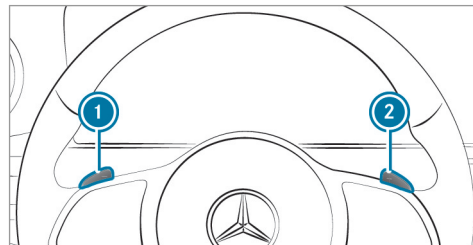

- ▶ Start the vehicle with the start/stop button (→ page 110) and simultaneously pull one of the steering wheel paddle shifters ① or ②.
 - The idle speed is increased briefly when starting the engine.

- The exhaust gas flaps are opened (sporty characteristic) (→ page 116).

Starting the vehicle using the SmartKey

You can also start the vehicle with the SmartKey in the ignition lock. The ignition lock is in the rear stowage space in the center console.

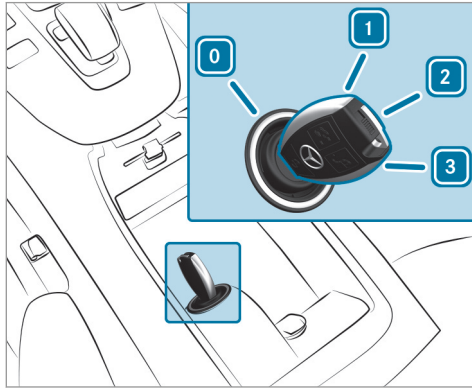

- 0** To remove the SmartKey
- 1** To switch on the power supply

- 2** To switch on the ignition
- 3** To start the engine

- ▶ Shift the transmission to position **P** or **N**.
- ▶ Depress the brake pedal.
- ▶ Insert the SmartKey into the ignition lock and turn to key position **3**.
- ▶ If the vehicle does not start:
 - Switch off consumers that are not required.
 - Remove the SmartKey from the ignition lock.
 - Insert the SmartKey into the ignition lock again after a short waiting period.
 - Turn the SmartKey to key position **2**. The indicator lamps in the instrument cluster light up.
 - Turn the SmartKey to key position **3**.
- i** You can also switch on the power supply or the ignition with the SmartKey. Additionally, turn the SmartKey to key position **1** or **2**.

Breaking-in notes

To preserve the engine during the first 1,000 miles (1,500 km):

- drive at varying road speeds and engine speeds.
- do not drive faster than 85 mph (140 km/h).
- allow the engine to reach a maximum engine speed of 4,500 rpm (4,500 rpm) only briefly.
- drive the vehicle in drive program **C**.
- change gear before the tachometer needle is $\frac{2}{3}$ of the way to the red area of the tachometer.
- do not shift down a gear manually in order to brake.
- avoid overstraining the vehicle, e.g. driving at full throttle.
- do not depress the accelerator pedal past the pressure point (kickdown).
- only increase the engine speed gradually and accelerate the vehicle to full speed after 1,000 miles (1,500 km).

112 Driving and parking

This also applies when the engine or parts of the drivetrain have been replaced.

Please also observe the following breaking-in notes:

- In certain driving and driving safety systems, the sensors adjust automatically while a certain distance is being driven after the vehicle has been delivered or after repairs. Full system effectiveness is not reached until the end of this teach-in process.
- Brakepads, brake discs and tires that are either new or have been replaced only achieve optimum braking effect and grip after several hundred kilometers of driving. Compensate for the reduced braking effect by applying greater force to the brake pedal.

Notes on driving

⚠ WARNING Risk of accident due to objects in the driver's footwell

Objects in the driver's footwell may impede pedal travel or block a depressed pedal.

This jeopardizes the operating and road safety of the vehicle.

- ▶ Stow all objects in the vehicle securely so that they cannot get into the driver's footwell.
- ▶ Always install the floor mats securely and as prescribed in order to ensure that there is always sufficient room for the pedals.
- ▶ Do not use loose floor mats and do not place floor mats on top of one another.

⚠ WARNING Risk of accident due to unsuitable footwear

Operation of the pedals may be restricted due to unsuitable footwear such as:

- Shoes with platform soles
- Shoes with high heels
- Slippers
- ▶ When driving always wear suitable shoes in order to be able to operate the pedals safely.

⚠ WARNING Risk of accident when switching off the ignition when driving

If you switch off the ignition while driving, safety functions are restricted or no longer available. This may affect the power steering system and the brake force boosting, for example.

You will then need to use considerably more force to steer and brake.

- ▶ Do not switch off the ignition while driving.

⚠ DANGER Risk of fatal injuries due to exhaust gases

Combustion engines emit poisonous exhaust gases such as carbon monoxide. Inhaling these exhaust gases is hazardous to health and can lead to poisoning.

- ▶ Never leave the engine running in an enclosed space without sufficient ventilation.

▲ WARNING Risk of skidding and of an accident due to shifting down on slippery road surfaces

If you shift down on slippery road surfaces to increase the engine braking effect, the drive wheels may lose traction.

- ▶ Do not shift down on slippery road surfaces to increase the engine braking effect.

▲ DANGER Risk of fatal injury due to poisonous exhaust gases

If the tailpipe is blocked or sufficient ventilation is not possible, poisonous exhaust gases such as carbon monoxide may enter the vehicle. This is the case if the vehicle gets stuck in snow, for example.

- ▶ Keep the tailpipe and the area around the vehicle free from snow when the engine or the stationary heater are running.

- ▶ Open a window on the windward side of the vehicle to ensure an adequate supply of fresh air.

▲ WARNING Risk of accident and injury due to being under the influence of alcohol and drugs while driving

Driving when under the influence of alcohol and/or drugs is an extremely dangerous combination. Even small quantities of alcohol or drugs may affect your reflexes, perception and judgment.

The probability of a serious or even fatal accident greatly increases if you drive when under the influence of alcohol or drugs.

- ▶ Do not drink alcohol or take drugs while driving, and do not allow anyone to drive who has been drinking alcohol or taking drugs.

▲ WARNING Risk of accident due to the brake system overheating

If you leave your foot on the brake pedal when driving, the brake system may overheat.

This increases the braking distance and the brake system may even fail.

- ▶ Never use the brake pedal as a footrest.
- ▶ Do not depress the brake pedal and the accelerator pedal at the same time while driving.

! NOTE Wearing out the brake linings by continuously depressing the brake pedal

- ▶ Do not depress the brake pedal continuously whilst driving.
- ▶ To use the braking effect of the engine, shift to a lower gear in good time.

! **NOTE** Damage to the drivetrain and engine when pulling away

- ▶ Do not warm up the engine while the vehicle is stationary. Pull away immediately.
- ▶ Avoid high engine speeds and driving at full throttle until the engine has reached its operating temperature.

! **NOTE** Damage to the catalytic converter due to non-combusted fuel

- The engine is not running smoothly and is misfiring.
Non-combusted fuel may get into the catalytic converter.
- ▶ Only depress the accelerator pedal slightly.
 - ▶ Have the cause rectified immediately at a qualified specialist workshop.

! **WARNING** Risk of accident due to incorrect gearshifting

If the engine speed is higher than the idle speed and you engage the transmission position **[D]** or **[R]**, the vehicle may accelerate sharply.

- ▶ If you engage the transmission position **[D]** or **[R]** always depress the brake pedal firmly and do not accelerate at the same time.

Limited braking effect on salt-treated roads:

- Due to salt build-up on the brake discs and brakepads, the braking distance can increase considerably or result in braking only on one side
- Maintain a much greater safe distance to the vehicle in front

To remove the layer of salt:

- Brake occasionally while paying attention to the traffic conditions

- Carefully depress the brake pedal at the end of the journey and when starting the next journey

Function of rear axle steering

Depending on the speed, rear axle steering adapts the track of the rear axle to the position of the front wheels. Together with the steering input of the front wheels, this results in greater mobility and improved stability.

Rear axle steering has the following characteristics:

- Reduced steering effort and turning radius resulting in reduced parking effort
- Improved driving stability, e.g. on bends
- More direct steering resulting in improved control of the vehicle

Information on the AMG ceramic high-performance composite brake system

The brake system is designed for heavy loads. This may lead to noise when braking. This effect can also occur after washing the vehicle.

The noise depends on the following factors:

- Speed
 - Brake force
 - Environmental conditions, e.g. temperature and air humidity
- ⓘ Have the brake system checked at a qualified specialist workshop after it has been subjected to extreme loads.

ECO start/stop function

Operation of the ECO start/stop function

The engine is switched off automatically in the following situations if all vehicle conditions for an automatic engine stop are met:

- You brake the vehicle to a standstill in transmission position **D** or **N**.

If you switch on the HOLD function in transmission position **D** or **N**, the engine will automatically stop in the following situations:

- You stop behind a vehicle that is pulling away.
 - You stop at a stop sign when there is no vehicle in front of you.
 - You turn the steering wheel hard at a low speed.
- ⓘ In transmission position **R**, the engine is not switched off automatically even when the HOLD function is switched on.

The engine is restarted automatically if:

- You release the brake pedal in transmission position **D** when the HOLD function is not active and the vehicle does not start to move.
- You shift from transmission position **P**.
- You release the brake pedal and the vehicle starts to move on a gentle downhill gradient at a speed below 3 mph (5 km/h).
- You depress the accelerator pedal.

- You permanently activate manual gearshifting.
- You pull the left-hand steering wheel paddle shifter.
- An automatic engine start is necessary.

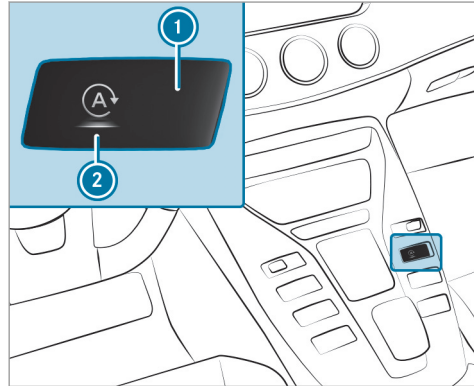

If the engine was switched off by the ECO start/stop function and you leave the vehicle, a warning tone sounds. The **Vehicle Ready to Drive Switch the Ignition Off Before Exiting** display message also appears in the multifunction display. If you do not switch off the ignition, the ignition is automatically switched off after one minute.

Deactivating or activating the ECO start/stop function



► Press display button ①.

The display button indicates current status ② of the ECO start/stop function:

-  OFF (red): deactivated
-  (green): activated
-  (yellow): inactive

AMG Performance exhaust system

Function of the AMG Performance exhaust system

Changing the position of the exhaust gas flaps allows you to select the sound characteristics of the AMG Performance exhaust system:

- Closed exhaust gas flaps: comfort characteristic (balanced)
- Open exhaust gas flaps: sporty characteristic (powerful)

Operating the AMG Performance exhaust system

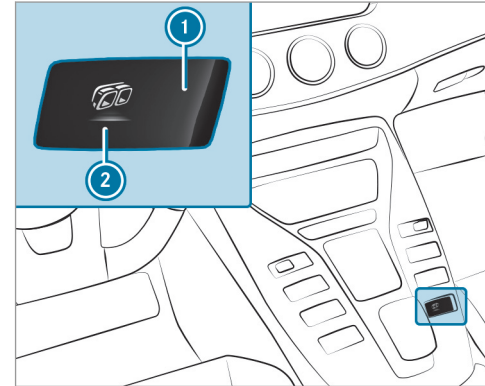

► Press display button ①.

The display button indicates the currently selected sound characteristic ②:

- Button symbol (blue): balanced
- Button symbol (red): powerful

Race track operation

Information on racetrack operation

- i** Racetrack operation is understood as the operation of the vehicle in extreme situations when it is used on race tracks or closed-off tracks.

Your vehicle may be used on both public roads and race tracks. The vehicle operating loads differ depending on use, which require differing maintenance intervals.

When the vehicle is operated on a racetrack, the component parts are subject to higher loads than on the road.

To account for these loads, the following measures in particular are taken as part of the maintenance intervals:

- Checking and replacing individual components
- Overhauling complete assemblies after specific periods of use

Additional checks must always be carried out on the vehicle before and after each use on a racetrack.

! **NOTE** Damage to component parts through a rise in temperature after operation on a racetrack

Switching the vehicle off directly after operation on a racetrack can lead to a continued temperature increase of the component parts as a result of heating while the vehicle is stationary.

The component parts may thereby be permanently damaged in exceptional cases.

- ▶ Do not switch off the vehicle immediately. Carry out cool down laps at low speed with minimal brake application. Assemblies under strain, such as the engine and the braking system, cool down faster this way.
- ▶ Always allow a Track-Check to be carried out at an authorized Mercedes-Benz Center before and after use on the racetrack.

Motorsport equipment, e.g. six-point seat belts, are only intended for use where road traffic regulations do not apply. This also applies to modifications to both the suspension and aerodynamic component parts.

You can obtain further information on servicing your vehicle from an authorized Mercedes-Benz Center.

Notes on the characteristics of individual vehicle assemblies

Due to specific vehicle operating loads in racetrack operation, additional requirements must be observed.

The following vehicle assemblies are affected in particular:

- Brake system
- Wheels and tires
- Suspension
- Aerodynamic components

Brake system

Notes on the brake system

The brake system of your vehicle is designed for heavy loads. Therefore, there may be noise when braking. The loads in the entire brake system which occur when driving on a racetrack are significantly greater than those during normal operation.

The increased brake forces and temperatures when driving on a racetrack inherently lead to increased wear of the brake system.

Check the condition and geometry of the brake cover plate before using the vehicle on a racetrack.

Observe the information on the cooling of components which are subject to loads when operated on a racetrack (→ page 117).

Braking with ABS

Repeated hard braking within the ABS control range causes higher temperatures in the brake system than controlled braking shortly before the ABS control limit.

Brakepad wear

The inner and outer brakepads may also suffer "tapered wear". This could lead to poor pedal feel. Therefore, you must also check the condition of the brakepads before and after use on a racetrack as part of a standard check for wear.

Brake discs

Observe the information on the cooling of components which are subject to strain in racetrack operation (→ page 117).

Depending on the vehicle's equipment, the AMG ceramic high-performance composite braking system is installed in your vehicle. The assessment of wear must therefore be carried out using a special measurement procedure. The brakes are measured using the current condition of the ceramic composite material as a criteria for assessing the wear instead of assessing the residual thickness.

Depending on the type of brake disc, the following are combinations used to measure the wear of the brake discs:

- Carbon-ceramic brake disc:

- Visual assessment of the brake disc for mechanical damage
- Wear measurement using the indicator field method; alternatively using the Proceq Carboteq® measuring device (e.g. in the AMG Performance Center or at AMG Trackdays)
- Gray cast iron brake disc:
 - Visual check
 - Crack test
 - Wear thickness test

The ventilation holes on gray cast iron friction rings of standard brake discs in particular could become blocked by brake dust. Therefore, check the ventilation holes before using the vehicle on a racetrack and clean them if necessary. If necessary, also clean the drilled holes.

Brake fluid

Check the following properties of the brake fluid before each use on a racetrack:

- Boiling point
- Fill level

When driving on a racetrack, make sure that the brake fluid is not more than 12 months old.

Brake caliper, brake hoses and brake lines

Check the following for damage each time before driving the vehicle on a racetrack:

- The dust boots on the brake calipers
- The brake hoses and brake lines

Replace them if necessary.

Brake cooling

Special air deflectors and channels are installed on the front and rear axles so that the brakes are cooled sufficiently. They supply the brake discs with cooling air. Check that they are in perfect condition and correctly installed each time before driving the vehicle on a racetrack. Excessive wear can be caused by driving over curbs, for instance. For this reason, regularly check they are all complete and installed securely.

In addition, check that the air guide plates are seated securely and clean before and after driving the vehicle on a racetrack.

Observe the information on the cooling of components which are subject to loads when driving on a racetrack (→ page 117).

Wheels and tires

Notes on wheels

! **NOTE** Restrictions relating to suspension settings and driving characteristics

Driving with wheels with differing dimensions of the following features could lead to restrictions relating to the suspension settings and driving characteristics of the vehicle:

- Diameter
- Wheel offset
- ▶ Only use the wheels provided by Mercedes-AMG for use on a racetrack.
- ▶ Only use wheels with approved geometry.

Do not use slick tires. Suspension and body components may otherwise be subjected to excessively high loads.

Observe the following notes on changing a wheel:

- Change the wheels after 9,320 miles (15,000 km) on a racetrack at the latest.
- To ensure concentricity and lateral trueness, check the wheel contact surface for damage when changing a wheel. These should also be measured in the event of imbalance.

The wheel bolts are subjected to high wear when used on a racetrack. To ensure the wheels are bolted securely on a permanent basis, replace the wheel bolts in the following situations:

- After approximately 620 miles (1,000 km) on a racetrack.
- After ten bolting procedures at the latest.

Notes on tires

⚠ **WARNING** Risk of accident from damaged tires

Damaged tires can cause tire pressure loss. As a result, you could lose control of your vehicle.

- ▶ Check the tires regularly for signs of damage and replace any damaged tires immediately.

Check the tires for damage and the correct tire tread depth both before and after use on a racetrack. Only then is it safe to drive on a racetrack and on public roads.

As a result of the driving style and at high ambient temperatures, when driving on a racetrack it may be necessary to compensate for the increase in pressure in warm tires by releasing air. Even for warm tires, the specified tire pressure may only be exceeded by max. 0.5 bar.

After the tires have cooled down again, you must readjust the tire pressure in accordance with the specifications in order to drive on public roads.

Suspension

Suspension settings

The factory setting provides a good compromise for driving on public roads and on a racetrack.

Vehicle measurements

Even small changes to the suspension settings alter the driving characteristics of the vehicle. To ensure optimal driving characteristics, the specified values and tolerances of the individual suspension settings must be complied with. The driving characteristics of the vehicle may otherwise be undesirable.

Vehicle measurements are required in the following situations:

- The vehicle height has changed in relation to the optimized setting.
- The vehicle is frequently subjected to very high loads, e.g. when driving over curbs.

Therefore, check the vehicle height at regular intervals and, if necessary, perform vehicle measurements.

Notes on suspension components

Despite regular checks, and regardless of whether the relevant suspension components are in good condition, the following components must be replaced after a certain amount of use on the racetrack:

- Wheel bolts (→ page 119)
- Wheel hubs including the wheel bearings

Aerodynamic components

Active aerodynamics profile

⚠ WARNING Risk of becoming trapped when you retract the active aerodynamics profile manually

When you retract the active aerodynamics profile manually, body parts may become trapped.

- ▶ Ensure that no one is in the movement range of the active aerodynamics profile when you are retracting the active aerodynamics profile.

- ▶ If someone becomes trapped during retraction of the active aerodynamics profile, press the display button again immediately.
The active aerodynamics profile will then extend again.

The active aerodynamics profile influences power output at the front axle. The component is programmed in such a way that it always moves into the ideal position for the speed and driving situation. Do not make any manual interventions.

Observe the additional information on the function of the active aerodynamics profile (→ page 156).

Fixed rear wing

i Only vehicles with the AMG Aerodynamic package are equipped with a fixed rear wing. The vehicle is delivered from the factory with the flat wing position. In order to improve rear axle power output, the rear wing can be moved to the inclined position for racetrack mode.

Observe the information about adjusting the rear wing and the permitted tightening torque (→ page 155).





Notes on engine oil

Check the engine oil level before operating in racetrack mode.



DYNAMIC SELECT switch

Function of the DYNAMIC SELECT switch

Use the DYNAMIC SELECT switch to change between the following drive programs:

-  **(Slippery)**: optimized pulling away and driving characteristics in wintry and slippery road conditions
-  **(Individual)**: individual settings
-  **(Comfort)**: comfortable and economical driving style
-  **(Sport)**: sporty driving style
-  **(Sport Plus)**: particularly sporty driving style



-  **(RACE)**: driving like on a race track

The  **(RACE)** drive program may not be used on normal roads.  **(RACE)** must only be activated and used on dedicated race circuits, not on public roads.

Mercedes-AMG recommends selecting the drive program  when in city traffic or stop-and-go traffic.

Depending on the drive program selected the following vehicle characteristics will change:

- Drive:
 - Engine and transmission management
 - Active Distance Assist DISTRONIC
- AMG Dynamics:
 - The four agility functions Basic, Advanced, Pro and Master are automatically selected depending on the drive program.
 - The steering, shift timing point and stabilization functions are adapted to the selected drive program.

- When ESP® is activated, agility function Pro is selected in drive program  RACE. The Master function is automatically selected when ESP® is deactivated.
- Position of the exhaust gas flaps
- Suspension
- Steering
- Availability of glide mode
- The  (**RACE**) drive program has the following properties:
 - The vehicle exhibits driving characteristics suited for race circuits.
 - All vehicle systems are designed for maximum sportiness.
 - The automatic transmission shifts up later.
 - The chassis has a particularly tight suspension and damping system.
 - Glide mode is not available.
 - The sporty sound characteristic of the exhaust system is activated.



 You can call up vehicle characteristics via the Performance menu in the on-board computer (→ page 174).

You can also change the following vehicle characteristics using the buttons in the center console:

- Position of the exhaust gas flaps
- Suspension

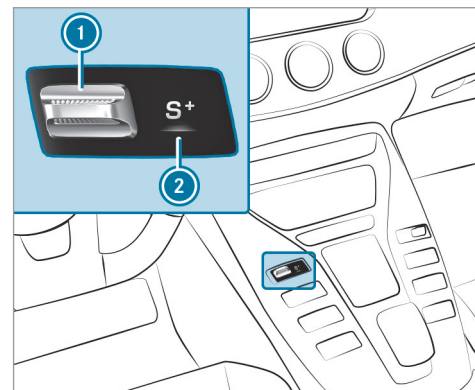
Selecting the drive program



- ▶ Press DYNAMIC SELECT switch  forwards or backwards. The selected drive program appears in display  and in the multifunction display in the instrument cluster.

Configuring drive program I

Multimedia system:

↳ Vehicle »  DYNAMIC SELECT
 » Individual

- ▶ Select the individual setting.

Switching the operation feedback for drive program on/off

Multimedia system:

↳ Vehicle »  DYNAMIC SELECT

- ▶ Switch **Notification for User** on or off . When this function is active, a corresponding message is shown in the media display when a drive program is selected with the DYNAMIC SELECT switch.

Displaying vehicle data

Multimedia system:

↳ Vehicle »  DYNAMIC SELECT

- ▶ Select **Vehicle Data**.
The vehicle data is displayed.

Displaying engine data

Multimedia system:

↳ Vehicle »  DYNAMIC SELECT

- ▶ Select **Engine Data**.
- ⓘ The values for engine output and engine torque may deviate from the nominal values. Items that can influence this are, for example:
 - Sea level
 - Fuel grade
 - Outside temperature

Automatic transmission

E-SELECT selector lever

Function of the E-SELECT selector lever

⚠ WARNING Risk of accident and injury due to children left unattended in the vehicle

If children are left unattended in the vehicle, they could:

- open doors, thereby endangering other persons or road users.
- get out of the vehicle and be hit by oncoming traffic.
- operate vehicle equipment and become trapped, for example.

In addition, children could also set the vehicle in motion, for example, by:

- releasing the parking brake.
- shifting the automatic transmission out of park position **P**.
- starting the engine

- ▶ Never leave children and animals unattended in the vehicle.
- ▶ When leaving the vehicle, always take the SmartKey with you and lock the vehicle.
- ▶ Keep the SmartKey out of the reach of children.

⚠ WARNING Risk of accident due to incorrect gearshifting

If the engine speed is higher than the idle speed and you engage the transmission position **D** or **R**, the vehicle may accelerate sharply.

- ▶ If you engage the transmission position **D** or **R** always depress the brake pedal firmly and do not accelerate at the same time.

Use the E-SELECT selector lever to change the transmission position. The current transmission position is displayed in the multifunction display.

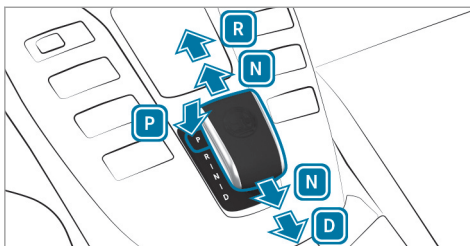

- P** Park position
- R** Reverse gear
- N** Neutral
- D** Drive position

Engaging reverse gear R

- ▶ Depress the brake pedal and push the E-SELECT selector lever upwards past the first point of resistance. The transmission position display shows **R** in the multifunction display.

Engaging neutral N

- ▶ Depress the brake pedal and push the E-SELECT selector lever up or down to the first point of resistance. The transmission position display shows **N** in the multifunction display.

Subsequently releasing the brake pedal will allow you to move the vehicle freely, e.g. to push it or tow it away.

If you want the automatic transmission to remain in neutral **N even if the ignition is switched off:**

- ▶ Start the vehicle.
- ▶ Depress the brake pedal and engage neutral **N**.
- ▶ Release the brake pedal.
- ▶ Switch off the ignition.
- ⓘ If you then exit the vehicle leaving the SmartKey in the vehicle, the automatic transmission remains in neutral **N**.

Engaging park position P

- ▶ Observe the notes on parking the vehicle (→ page 130).
- ▶ Depress the brake pedal until the vehicle is stationary.
- ▶ When the vehicle is stationary, press the **P** button.
Park position is only engaged when the **P** transmission position display is shown in the multifunction display. If no **P** transmission position display appears, secure the vehicle to prevent it from rolling away.

Park position **P** is engaged automatically if one of the following conditions is met:

- You switch off the ignition when the vehicle is stationary and the transmission is in position **D** or **R**.
 - You open the driver's door when the vehicle is stationary or when driving at a very low speed and the transmission is in position **D** or **R**.
- i** To maneuver with an open driver's door, open the driver's door while stationary and

engage transmission position **D** or **R** again.

Engaging drive position D

- ▶ Depress the brake pedal and pull the E-SELECT selector lever back past the first point of resistance.
The transmission position display shows **D** in the multifunction display.

When the automatic transmission is in transmission position **D**, it shifts the gears automatically. This depends on the following factors:

- The selected drive program
- The position of the accelerator pedal
- The driving speed

Notes on the double-clutch function

The double-clutch function is active when changing down in all drive programs. The double-clutch function reduces load change reactions and supports sporty driving. The acoustic perception of the double-clutch function changes depending on the drive program.

Rocking the vehicle free

Rocking the vehicle free can help to free a vehicle that has become trapped in slush or snow.

To rock the vehicle free, move the E-SELECT selector lever upwards and downwards past the point of resistance in order to switch between transmission positions **D** and **R** (→ page 123).

- i** The maximum design speed when switching between **D** and **R** is 6 mph (9 km/h).

Manual gearshifting

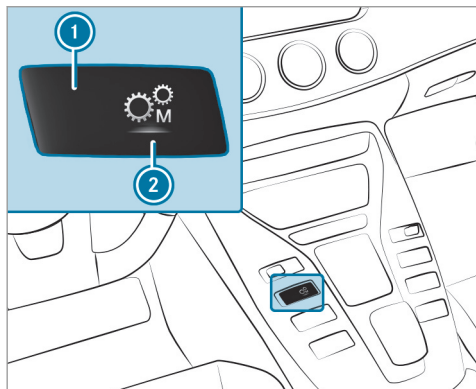

▶ **To activate/deactivate:** press display button ①.

The display button displays the currently selected gear setting ②:

- **M** (red): manual gearshifting
- **D** (blue): automatic transmission

① To permanently shift the gears manually in drive program **[L+]** using the steering wheel paddle shifters, select the **M** (Manual) setting for the transmission.

! **NOTE** Damage to the engine due to shifting up too late

The automatic transmission does not shift up in manual mode even when the engine's limiting speed is reached.

The fuel supply is interrupted in order to prevent the engine from overrevving.

▶ Shift up before the engine speed reaches the red area in the tachometer.

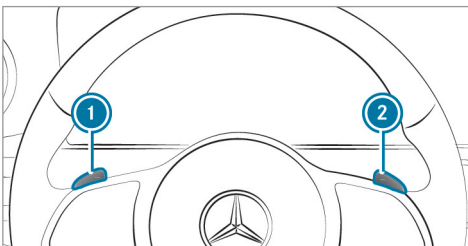

▶ **To shift up:** pull steering wheel paddle shifter ②.

▶ **To shift down:** pull steering wheel paddle shifter ①.

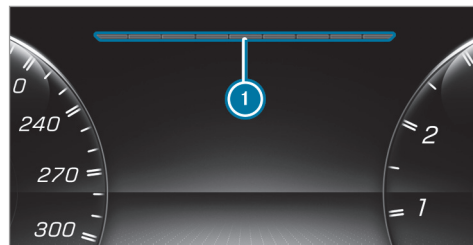

If the engine speed is too high or too low, you cannot change gear using the steering wheel paddle shifters. In this case, segments ① light up red.

Gearshift recommendation

The gearshift recommendation assists you in adopting an economical driving style.

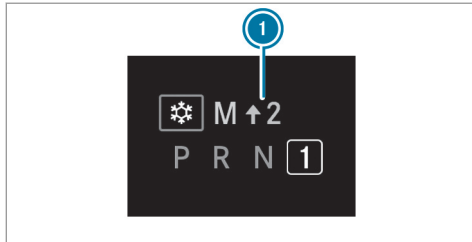

- ▶ If gearshift recommendation message ① is shown on the multifunction display, shift to the recommended gear.
- ① Gearshift recommendation is active only if you have activated manual gearshifting with the button on the center console.

Using kickdown

- ▶ **Maximum acceleration:** depress the accelerator pedal beyond the pressure point.

During kickdown, you cannot change gears using the steering wheel paddle shifters. The automatic transmission shifts up to the next gear

when the maximum engine speed is reached to protect the engine from overrevving.

- ① If you have activated manual gearshifting with the button in the center console, the transmission does not react to the kickdown.

Glide mode function

With an anticipatory driving style, glide mode helps you to reduce fuel consumption.

Glide mode is characterized by the following:

- The combustion engine is switched off. All of the vehicle functions remain active.
- The  symbol will appear on the multifunction display.

Glide mode is activated if the following conditions are met:

- The ECO start/stop function is activated.
- Drive program  is selected with the drive setting "Moderate" or "Reduced".
- The speed is within a suitable range.

- The road's course is suitable, e.g. no steep uphill or downhill inclines or tight bends.
- You are no longer depressing the accelerator or brake pedal.

Glide mode is deactivated again if one of the conditions is no longer met.

Refueling

Refueling the vehicle

⚠ WARNING Risk of fire or explosion from fuel

Fuels are highly flammable.

- ▶ Fire, open flames, smoking and creation of sparks must be avoided.
- ▶ Switch off the ignition and, if available, the stationary heater, before and while refueling the vehicle.

⚠ WARNING Risk of injury from fuels

Fuels are poisonous and hazardous to your health.

- ▶ Do not swallow fuel or let it come into contact with skin, eyes or clothing.
- ▶ Do not inhale fuel vapor.
- ▶ Keep children away from fuel.
- ▶ Keep doors and windows closed during the refueling process.

If you or other people come into contact with fuel, observe the following:

- ▶ Immediately rinse fuel off your skin with soap and water.
- ▶ If fuel comes into contact with your eyes, immediately rinse them thoroughly with clean water. Seek medical attention immediately.
- ▶ If you swallow fuel, seek medical attention immediately. Do not induce vomiting.
- ▶ Change immediately out of clothing that has come into contact with fuel.

⚠ WARNING Risk of fire or explosion from electrostatic charge

Electrostatic charge can create sparks and thereby ignite fuel vapors.

- ▶ Before opening the fuel filler cap or taking hold of the pump nozzle, touch the metallic body of the vehicle. This discharges any electrostatic charge that may have built up.
- ▶ Do not get into the vehicle again during the refueling process. Otherwise, electrostatic charge could build up again.

! NOTE Damage caused by the wrong fuel

Vehicles with a gasoline engine:

Even small amounts of the wrong fuel could result in damage to the fuel system, the engine and the emission control system.

- ▶ The RON requirement is located in the fuel filler flap.

- ▶ Only refuel with low-sulfur unleaded fuel.

This fuel may contain up to 10% ethanol. Your vehicle is suitable for use with E10 fuel.

Never refuel using any of the following fuels:

- Diesel
- Gasoline with more than 10% ethanol by volume, e.g. E15, E85, E100
- Gasoline with more than 3% methanol by volume, e.g. M15, M30, M85, M100
- Gasoline with additives containing metal

If you accidentally refuel with the wrong fuel:

- ▶ Do not switch the ignition on.
- ▶ Consult a qualified specialist workshop.

! **NOTE** Do not use diesel to refuel vehicles with a gasoline engine

If you have accidentally refueled with the wrong fuel:

- Do not switch the ignition on. Otherwise fuel can enter the engine.

Even small amounts of the wrong fuel could result in damage to the fuel system and the engine. The repair costs are high.

- ▶ Consult a qualified specialist workshop.
- ▶ Have the fuel tank and fuel lines drained completely.

! **NOTE** Damage to the fuel system caused by overfilled fuel tanks

- ▶ Only fill the fuel tank until the pump nozzle switches off.

! **NOTE** Fuel may spray out when you remove the fuel pump nozzle

- ▶ Only fill the fuel tank until the pump nozzle switches off.

Requirements

- The vehicle is unlocked (→ page 55).
- ⓘ Do not get into the vehicle again during the refueling process. Otherwise, electrostatic charge could build up again.

Observe the notes on operating fluids (→ page 362).

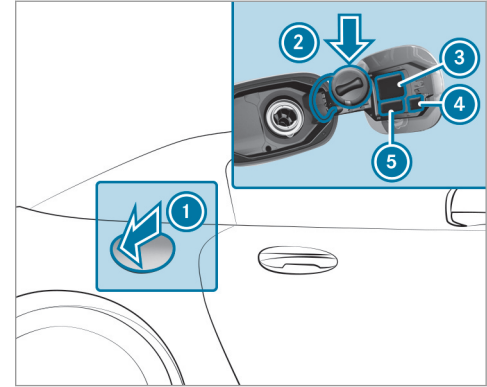

- 1 Fuel filler flap
- 2 Bracket for the fuel filler cap
- 3 Tire pressure table
- 4 QR code for rescue card
- 5 Fuel type

- ▶ Press on the back area of fuel filler flap ①.
- ▶ Turn the fuel filler cap counter-clockwise and remove it.

- ▶ Insert the fuel filler cap into bracket ②.
- ▶ Completely insert the pump nozzle into the tank filler neck, hook in place and refuel.
- ▶ Only fill the fuel tank until the pump nozzle switches off.
- ▶ Replace the cap on the filler neck and turn clockwise until it engages audibly.
- ▶ Close fuel filler flap ①.

Parking

Parking the vehicle

⚠ WARNING Risk of accident and injury caused by an insufficiently secured vehicle rolling away.

If the vehicle is not securely parked sufficiently, it can roll away in an uncontrolled way even at a slight downhill gradient.

- ▶ Ensure that the parked vehicle is always properly secured against rolling away as follows:

- On uphill or downhill gradients, turn the front wheels so that the vehicle rolls towards the curb if it starts moving.
- Apply the parking brake.
- Switch the transmission to position **P**.

⚠ WARNING Risk of fire caused by hot exhaust system parts

Flammable material such as leaves, grass or twigs may ignite if they come into contact with hot parts of the exhaust system or exhaust gas flow.

- ▶ Park the vehicle so that no flammable material can come into contact with hot vehicle components.
- ▶ In particular, do not park on dry grass-land or harvested grain fields.

⚠ WARNING Risk of accident and injury due to children left unattended in the vehicle

If children are left unattended in the vehicle, they could:

- Open doors, thereby endangering other persons or road users.
- Get out and be struck by oncoming traffic.
- Operate vehicle equipment and become trapped, for example.

In addition, the children could also set the vehicle in motion, for example by:

- Releasing the parking brake.
- Changing the transmission position.
- Starting the vehicle.
- ▶ Never leave children unattended in the vehicle.
- ▶ When leaving the vehicle, always take the key with you and lock the vehicle.

- ▶ Keep the vehicle key out of reach of children.

! **NOTE** Damage to the vehicle due to it rolling away

- ▶ Always secure the vehicle against rolling away.

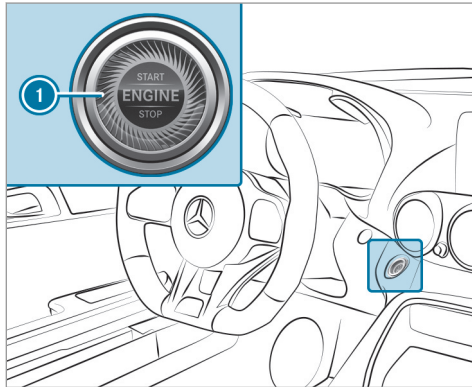

- ▶ Bring the vehicle to a standstill by applying the brake pedal.
- ▶ On uphill or downhill gradients, turn the front wheels so that the vehicle rolls towards the curb if it starts moving.
- ▶ Apply the electric parking brake.
- ▶ Engage transmission position **P** in a stationary vehicle with the brake pedal applied (→ page 125).
- ▶ Switch off the engine and the ignition by pressing button **1**.
- ▶ Release the service brake slowly.
- ▶ Get out of the vehicle and lock it.

Garage door opener

Programming buttons for the garage door opener

! **DANGER** Risk of fatal injuries due to exhaust gases

Combustion engines emit poisonous exhaust gases such as carbon monoxide. Inhaling

these exhaust gases is hazardous to health and can lead to poisoning.

- ▶ Never leave the engine running in an enclosed space without sufficient ventilation.

! **WARNING** Risk of injury when opening or closing a door with the garage door opener

When you operate or program the door with the integrated garage door opener, people in the range of movement of the door may become trapped or struck by the door.

- ▶ When using the integrated garage door opener, always make sure that nobody is within the range of movement of the door.

Only operate the following doors using the garage door opener:

- Doors with a safety stop and reversing feature.

- Doors which conform to the current U.S. safety standards.

Requirements:

- The vehicle has been parked outside the garage and outside the range of movement of the door.
- The engine is switched off.
- The ignition is switched on.

i The garage door opener function is always available when the ignition is switched on.

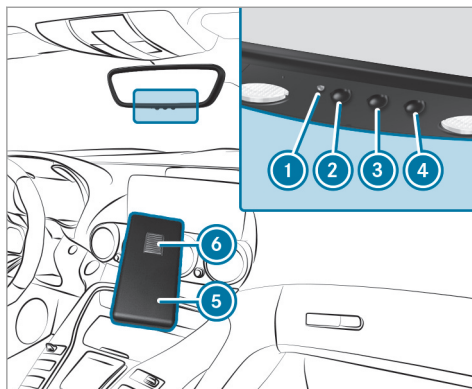

- ▶ Check if the transmission frequency of the remote control has the frequency range of 280 to 868 MHz.

Radio equipment approval number:

- NZLMUAHL5 (USA)
- 4112A-MUAHL5 (Canada)

- ▶ Press and hold button **2**, **3** or **4** that you wish to program.
Indicator lamp **1** flashes yellow.

i It can take up to 20 seconds before the indicator lamp flashes yellow.

- ▶ Release the previously pressed button.
Indicator lamp **1** continues to flash yellow.

- ▶ Point remote control **5** from a distance of 1 in (1 cm) to 3 in (8 cm) towards buttons **2**, **3** or **4**.

- ▶ Press and hold button **6** of remote control **5** until one of the following signals appears:

- Indicator lamp **1** lights up green continuously. Programming is complete.
- Indicator lamp **1** flashes green. Programming was successful. Additionally, synchronization of the rolling code with the door system must also be carried out.

- ▶ If indicator lamp **1** does not light up or flash green: repeat the procedure.

- ▶ Release all of the buttons.

- i** The remote control for the door drive is not included in the scope of delivery of the garage door opener.

Synchronizing the rolling code Requirements:

- The door system uses a rolling code.
- The vehicle must be within range of the garage door or door drive.
- The vehicle as well as persons and objects, are located outside the range of movement of the door.

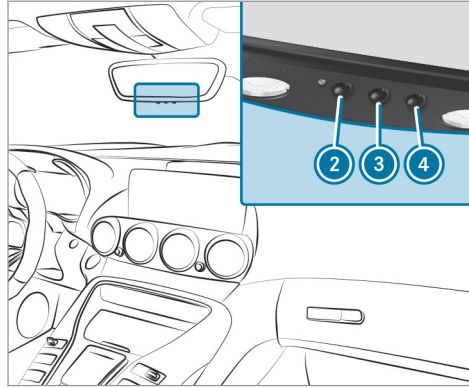

- ▶ Press the programming button on the door drive unit. Initiate the next step within approximately 30 seconds.
- ▶ Press previously programmed button **2**, **3** or **4** repeatedly until the door closes. When the door closes, programming is completed.

- i** Please also read the operating instructions for the door drive.

Troubleshooting when programming the remote control

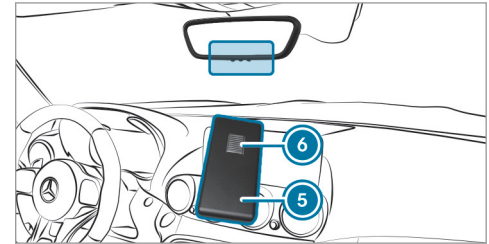

- ▶ Check if the transmitter frequency of remote control **5** is supported.
- ▶ Replace the batteries in remote control **5**.
- ▶ Hold remote control **5** at various angles at a distance between 1 in (1 cm) to 3 in (8 cm) in front of the inside rearview mirror. You should test every position for at least 25 seconds before trying another position.

- ▶ Hold remote control ⑤ at the same angles at various distances in front of the inside rearview mirror. You should test every position for at least 25 seconds before trying another position.
- ▶ Note that some remote controls transmit only for a limited period, press button ⑥ on remote control ⑤ again before transmission ends.
- ▶ Align the antenna line of the door opener unit with the remote control.

① Support and additional information on programming:

- On the toll free HomeLink® Hotline on 1-800-355-3515.
- On the Internet at <http://www.homelink.com/mercedes>.

Opening or closing the door Requirements

- The corresponding button is programmed to operate the door.

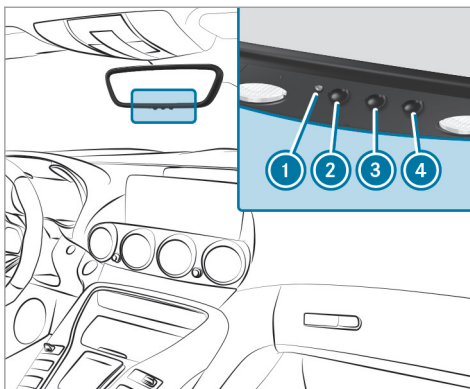

- ▶ Press and hold buttons ②, ③ or ④ until the door opens or closes.
- ▶ If indicator lamp ① flashes yellow after approximately 20 seconds: press and hold the previously pressed button again until the door opens or closes.

Clearing the garage door opener memory

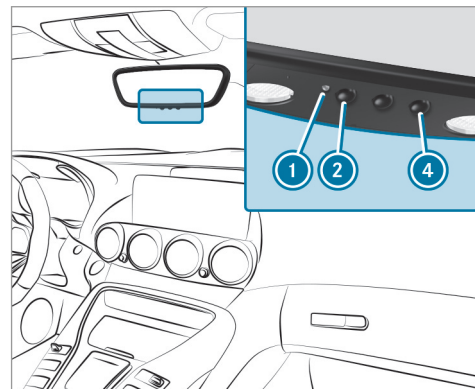

- ▶ Press and hold buttons ② and ④. Indicator lamp ① lights up yellow.
- ▶ If indicator lamp ① flashes green: release buttons ② and ④. The entire memory has been deleted.

Radio equipment approval numbers for the garage door opener

Radio equipment approval numbers



Brazil

Este equipamento opera em caráter secundário, isto é, não tem direito à proteção contra interferência prejudicial, mesmo de estações do mesmo tipo, e não pode causar interferência a sistemas operando em caráter primário.

Para maiores informações acessar www.anatel.gov.br

Radio equipment approval numbers

Country	Radio type approval number
Egypt	TAC.2511151293.WIR
Andorra	CE
Australia	R-NZ
Barbados	MED1578
Chile	2488/DFRS20576/F-74
European Union	CE
Gibraltar	CE
Iceland	CE
Jordan	TRC/LPD/2015/299
Canada	IC: 4112A-MUAHL5
Kuwait	CE
Liechtenstein	CE

Country	Radio type approval number
Mexico	RCPGEMU15-0448
Monaco	CE
New Zealand	R-NZ
Norway	CE
Russian Federation	Not required
Saudi Arabia	TA 10525
Switzerland	CE
South Africa	 TA-2015/1386
Turkey	Not required

Country	Radio type approval number
United Arab Emirates	ER41849/15 Dealer No: DA35176/14
United States	FCC ID: NZLNUAHL5

Further information on the declaration of conformity for wireless vehicle components (→ page 23).

Electric parking brake

Electric parking brake function (applying automatically)

⚠ WARNING Risk of accident and injury due to children left unattended in the vehicle

If children are left unattended in the vehicle, they could:

- Open doors, thereby endangering other persons or road users.
- Get out and be struck by oncoming traffic.
- Operate vehicle equipment and become trapped, for example.

In addition, the children could also set the vehicle in motion, for example by:

- Releasing the parking brake.
- Changing the transmission position.
- Starting the vehicle.

- ▶ Never leave children unattended in the vehicle.
- ▶ When leaving the vehicle, always take the key with you and lock the vehicle.
- ▶ Keep the vehicle key out of reach of children.

The electric parking brake is applied if the transmission is in position **P** and one of the following conditions is fulfilled:

- The engine is switched off.
- The seat belt tongue is not inserted in the seat belt buckle of the driver's seat and the driver's door is opened.

i To prevent application: pull the handle of the electric parking brake.

In the following situations, the electric parking brake is also applied:

- Active Distance Assist DISTRONIC is bringing the vehicle to a standstill.
- The HOLD function is keeping the vehicle stationary.

- Active Parking Assist is keeping the vehicle stationary.

This is the case if one of the following conditions is also fulfilled:

- The engine is switched off.
- The seat belt tongue is not inserted in the seat belt buckle of the driver's seat and the driver's door is opened.
- There is a system malfunction.
- The power supply is insufficient.
- The vehicle is stationary for a lengthy period.

When the electric parking brake is applied, the red **PARK** (USA) or **(P)** (Canada) indicator lamp appears in the instrument cluster.

The electric parking brake is not automatically applied if the engine is switched off by the ECO start/stop function.

Electric parking brake function (releasing automatically)

The electric parking brake is released when the following conditions are fulfilled:

- The driver's door is closed.
- The engine is running.
- The transmission is in position **D** or **R** and you depress the accelerator pedal or you shift from transmission position **P** to **D** or **R** when on level ground with the driver's door closed.
- If the transmission is in position **R**, the trunk lid must be closed.
- The seat belt tongue is inserted into the seat belt buckle of the driver's seat.

If the seat belt tongue is not inserted into the seat belt buckle of the driver's seat, the following conditions must be fulfilled:



- You shift from transmission position **P**.
- You have previously driven at speeds greater than 2 mph (3 km/h).

When the electric parking brake is released, the red **PARK** (USA) or **(P)** (Canada) indicator lamp in the instrument cluster goes out.

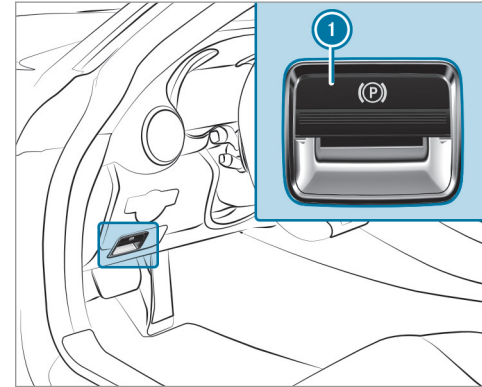

Applying/releasing the electric parking brake manually

Applying





- ▶ Push handle ①.
The red  (USA) or  (Canada) indicator lamp appears in the instrument cluster.
- ① The electric parking brake is only securely applied if the indicator lamp is lit continuously.

Releasing

- ▶ Switch on the ignition.
- ▶ Pull handle ①.
The red  (USA) or  (Canada) indicator lamp in the instrument cluster goes out.

Emergency braking

- ▶ Press and hold handle ①.
As long as the vehicle is driving, the **Please Release Parking Brake** message is displayed. When the vehicle has been braked to a standstill, the electric parking brake is applied. The red  (USA) or  (Canada) indicator lamp appears in the instrument cluster.

Notes on parking the vehicle for an extended period

If you leave the vehicle parked for longer than six weeks, it may suffer disuse damage.

The 12 V battery may also be impaired or damaged by heavy discharging.

- ① Further information can be obtained at a qualified specialist workshop.

Driving and driving safety systems

Driving systems and your responsibility

Your vehicle is equipped with driving systems which assist you in driving, parking and maneuvering the vehicle. The driving systems are aids and do not relieve you of your responsibility pertaining to road traffic law. Pay attention to the traffic conditions at all times and intervene when necessary. Be aware of the limitations regarding the safe use of these systems.

Information on radar and ultrasonic sensors

Some driving and driving safety systems use radar or ultrasonic sensors to monitor the area in front of, behind or next to the vehicle (depending on the vehicle's equipment).

Depending on the vehicle's equipment, the radar sensors are integrated behind the bumpers and/or behind the Mercedes star. The ultrasonic sensors are located in the front and rear bumpers. Keep these parts free of dirt, ice and slush (→ page 307). The sensors must not be covered, for example by cycle racks, overhanging loads, stickers, foil or foils to protect against stone chipping. Additional license plate brackets can likewise impair the function of the ultrasonic sensors. In the event of damage to the bumpers or radiator grill, or following a collision impacting the bumpers or radiator grill, have the function of the sensors checked at a qualified specialist workshop. If the sensors are damaged, some driving systems and driving safety systems may no longer function properly.

Overview of driving systems and driving safety systems

In this section, you will find information about the following driving systems and driving safety systems:

- ABS (**A**nti-**l**ock **B**raking **S**ystem) (→ page 139)
- Active Distance Assist DISTRONIC (→ page 147)
- AMG adaptive sport suspension system (→ page 157)
- Active Brake Assist (→ page 142)
- Lane Keeping Assist (→ page 167)
- ATTENTION ASSIST (→ page 163)
- BAS (**B**rake **A**ssist **S**ystem) (→ page 139)
- Hill Start Assist (→ page 151)
- EBD (**E**lectronic **B**rake**f**orce **D**istribution) (→ page 142)
- ESP® (**E**lectronic **S**tability **P**rogram) (→ page 140)
- HOLD function (→ page 151)
- Parking Assist PARKTRONIC (→ page 158)
- Front and rear view camera (→ page 161)
- RACE START (→ page 152)
- Cruise control (→ page 145)
- Blind Spot Assist (→ page 166)
- Traffic Sign Assist (→ page 164)

Function of ABS

The Anti-lock Brake System (ABS) regulates the brake pressure in critical driving situations:

- During braking, e.g. at full brake application or insufficient tire traction, the wheels are prevented from locking.
- Vehicle steerability while braking is ensured.

If ABS intervenes when braking, you will feel a pulsing in the brake pedal. The pulsating brake pedal can be an indication of hazardous road conditions and can serve as a reminder to take extra care while driving.

System limits

- ABS is active from speeds of approx. 5 mph (8 km/h).
- ABS may be impaired or may not function if a malfunction has occurred and the yellow  ABS warning lamp lights up continuously in the instrument cluster after the engine is started.

Function of BAS (Brake Assist System)

▲ WARNING Risk of an accident caused by a malfunction in BAS (Brake Assist System)

If BAS is malfunctioning, the braking distance in an emergency braking situation is increased.

▶ Depress the brake pedal with full force in emergency braking situations. ABS prevents the wheels from locking.

BAS supports your emergency braking situation with additional brake force.

If you depress the brake pedal quickly, BAS is activated:

- BAS automatically boosts the brake pressure.
- BAS can shorten the braking distance.
- ABS prevents the wheels from locking.

The brakes will function as usual once you release the brake pedal. BAS is deactivated.

Functions of ESP® (Electronic Stability Program)

⚠ WARNING Risk of skidding if ESP® is malfunctioning

If ESP® is malfunctioning, ESP® cannot carry out vehicle stabilization. In addition, other driving safety systems are switched off.

- ▶ Drive on carefully.
- ▶ Have ESP® checked at a qualified specialist workshop.

You can select between the following modes of ESP®:

- ESP® ON
- ESP® SPORT
- ESP® OFF

Characteristics when ESP® is activated

ESP® monitors and improves driving stability and traction, particularly in the following situations:

- When pulling away on a wet or slippery roadway.
- When braking.

ESP® can stabilize the vehicle by intervening in the following ways:

- One or more wheels are braked.
- The engine output is adapted according to the situation.

ESP® is activated every time the engine is started regardless of whether ESP® was in ESP® SPORT or deactivated before the engine was switched off.

If the  ESP® warning lamp flashes in the instrument cluster, one or several vehicle wheels has reached its grip limit:

- Adapt the driving style to suit the prevailing road and weather conditions.
- Do not deactivate ESP® under any circumstances.
- Only depress the accelerator pedal as far as is necessary.

Characteristics when ESP® SPORT is activated

⚠ WARNING Risk of skidding if ESP® SPORT is used incorrectly

When you activate ESP® SPORT, there is an increased risk of skidding and having an accident.

- ▶ Activate ESP® SPORT only in the circumstances described below.

Select ESP® SPORT when the vehicle's own oversteering and understeering characteristics are desired, e.g. on designated roads.

Driving with ESP® SPORT or with ESP® deactivated requires an extremely qualified and experienced driver.

If ESP® SPORT is activated and one or more wheels start to spin, the  ESP® warning lamp on the instrument cluster flashes. ESP® then only stabilizes the vehicle to a limited degree.

ESP® SPORT also has the following characteristics:

- ESP® only improves driving stability to a limited degree.
- ETS/4ETS traction control is still active.
- The engine's torque is only restricted to a limited degree and the drive wheels can spin. The spinning of the wheels results in a cutting action for better traction on loose surfaces.
- ESP® continues to provide assistance when the brakes are firmly applied.

Characteristics when ESP® is deactivated

⚠ WARNING Risk of skidding if ESP® is deactivated

If you deactivate ESP®, ESP® cannot carry out vehicle stabilization.

▶ ESP® should only be deactivated in the following situations.

When ESP® is deactivated, the  ESP® OFF warning lamp and the **ESP OFF** message light up continuously in the instrument cluster.

Deactivating ESP® has the following effects:

- Driving stability will no longer be improved.
 - The drive wheels could spin.
 - ETS/4ETS traction control is still active.
- ⓘ Even when ESP® is deactivated, you are still assisted by ESP® when braking hard.

It may be best to activate ESP® SPORT or deactivate ESP® in the following situations:

- When using snow chains.

- In deep snow.
 - On sand or gravel.
- ⓘ Spinning the wheels results in a cutting action, which enhances traction.
- ⓘ Activate ESP® as soon as the situations described above no longer apply. ESP® will otherwise not be able to stabilize the vehicle if the vehicle starts to skid or a wheel starts to spin.

If the  ESP® warning lamp lights up continuously even when ESP® is activated, ESP® is not available due to a malfunction.

Observe any information which may be displayed in the instrument cluster:

- Warning and indicator lamps (→ page 416)
- Display messages

ETS/4ETS (Electronic Traction System)

ETS/4ETS traction control is part of ESP®.





ETS/4ETS can improve the vehicle's traction by intervening in the following ways:

- The drive wheels are braked individually if they spin.

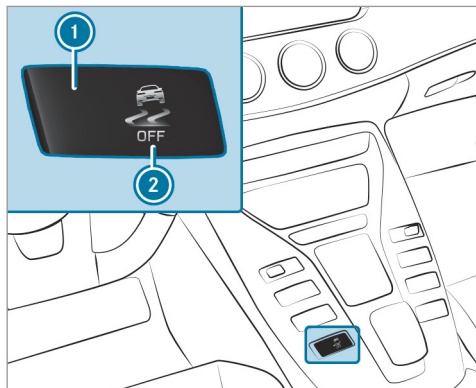
- More drive torque is transferred to the wheel or wheels with traction.

Activating/deactivating ESP® (Electronic Stability Program)



- ▶ **To activate ESP® SPORT:** press and hold display button ① until the road in button symbol ② lights up yellow. The **ESP SPORT** message is shown in the instrument cluster and the  and  warning lamps light up.
- ▶ **To deactivate ESP®:** press and hold display button ① until the road in button symbol ② lights up red. The **ESP OFF** message is shown in the instrument cluster and the  and **ESP OFF** warning lamps light up.
- ▶ **To activate ESP®:** press and hold display button ① until the road in button symbol ② lights up blue. The  and  warning lamps in the instrument cluster go out.

When the  symbol ② is shown with a red ! on display button ①, ESP® is malfunctioning. Observe the information on warning lamps and display messages which may be shown in the instrument cluster.

Function of EBD (electronic brake force distribution)

EBD is characterized by the following:

- Monitoring and regulating the brake pressure on the rear wheels.
- Improved driving stability when braking, especially on bends.

Function of Active Brake Assist

Active Brake Assist consists of:

- Distance warning function
- Autonomous braking function
- Situation-dependent braking assistance

Active Brake Assist can help you to minimize the risk of a collision with vehicles or to reduce the effects of such a collision.

If Active Brake Assist has detected a risk of collision, a warning tone sounds and the  distance warning lamp lights up in the instrument cluster.

If you do not react to the visual or acoustic warning, autonomous braking can be initiated in critical situations.

In especially critical situations, Active Brake Assist can initiate autonomous braking directly. In this case, the warning lamp and warning tone occur simultaneously with the braking application.

If you apply the brake yourself in a situation detected as critical by Active Brake Assist, or apply the brake during autonomous braking, situation-dependent braking assistance occurs. The brake pressure increases up to maximum full-stop braking if necessary.

If the autonomous braking function or the situation-dependent braking assistance is triggered, additional preventive measures for occupant protection (PRE-SAFE®) may also be initiated, if the vehicle is equipped with these.

⚠ WARNING Risk of an accident caused by limited detection performance of Active Brake Assist

Active Brake Assist cannot always clearly identify objects and complex traffic situations.

In such cases, Active Brake Assist might:

- Give a warning or brake without reason
 - Not give a warning or not brake
- ▶ Always pay careful attention to the traffic situation; do not rely on Active Brake Assist alone. Active Brake Assist is only an aid. The driver is responsible for maintaining a suitable distance to the vehicle in front, vehicle speed and for braking in good time.
- ▶ Be prepared to brake or swerve if necessary.

Observe the system limitations of Active Brake Assist.

The individual subfunctions are available in the following speed ranges:
Distance warning function

The distance warning function issues a warning at speeds:

- From approximately 4 mph (7 km/h), if your vehicle is critically close to a vehicle or pedestrian. An intermittent warning tone sounds and the  distance warning lamp lights up in the instrument cluster.

Brake immediately or take evasive action, provided it is safe to do so and the traffic situation allows this.

The distance warning function can aid you in the following situations with an intermittent warning tone and a warning lamp:

Vehicles traveling in front	Up to approx. 155 mph (250 km/h)
Stationary vehicles	Up to approx. 44 mph (70 km/h)

Autonomous braking function

If the vehicle is traveling at speeds above approximately 4 mph (7 km/h), the autonomous braking function may intervene in the following situations:

	Vehicles without Active Distance Assist DISTRONIC	Vehicles with Active Distance Assist DISTRONIC
Vehicles traveling in front	Up to approx. 65 mph (105 km/h)	Up to approx. 124 mph (200 km/h)
Stationary vehicles	Up to approx. 31 mph (50 km/h)	Up to approx. 31 mph (50 km/h)

Situation-dependent braking assistance

Situation-dependent braking assistance may intervene at speeds above approximately 4 mph (7 km/h) in the following situations:

Vehicles traveling in front	Up to approx. 155 mph (250 km/h)
Stationary vehicles	Up to approx. 44 mph (70 km/h)

Canceling a brake application of Active Brake Assist

You can cancel a brake application by Active Brake Assist at any time by:

- Fully depressing the accelerator pedal or with kickdown.
- Releasing the brake pedal.

Active Brake Assist may cancel the brake application when one of the following conditions is fulfilled:

- You maneuver to avoid the obstacle.
- There is no longer a risk of collision.

- An obstacle is no longer detected in front of your vehicle.

System limitations

The system may be impaired or may not function in the following situations:

- In snow, rain, fog, heavy spray, if there is glare, in direct sunlight or in greatly varying ambient light.
- If the sensors are dirty, fogged up, damaged or covered.
- If the sensors are impaired due to interference from other radar sources, e.g. strong radar reflections in parking garages.
- If a loss of tire pressure or a defective tire has been detected and displayed.
- Full system performance is not available for a few seconds after switching on the ignition or after driving off.
- In complex traffic situations where objects cannot always be clearly identified.
- For vehicles if they move quickly into the sensor detection range.

- On bends with a tight radius.

Setting Active Brake Assist

Multimedia system:

→ Vehicle → Assistance

▶ Active Brake Assist

- ▶ Activate or deactivate the function.
- ⓘ It is recommended that you always leave Active Brake Assist activated.
- ⓘ If Active Brake Assist is deactivated, the  symbol appears in the status bar of the multifunction display.

Speed control cruise control

Function of cruise control

Cruise control regulates the speed to the value selected by the driver.

If you accelerate to overtake, for example, the stored speed is not deleted. If you remove your foot from the accelerator pedal after overtaking, cruise control will resume speed regulation back to the stored speed.

Cruise control is operated using the corresponding steering wheel buttons. You can store any speed above 19 mph (30 km/h) up to the maximum speed.

If you fail to adapt your driving style, cruise control can neither reduce the risk of an accident nor override the laws of physics. It cannot take into account road, weather or traffic conditions. Cruise control is only an aid. The driver is responsible for the distance to the vehicle in front, for vehicle speed, for braking in good time and for staying in lane.

Displays on the multifunction display

The status of cruise control and the stored speed are shown in the multifunction display.



- 1 Cruise control is selected
 - 2 Speed is saved, cruise control is deactivated
 - 3 Speed is saved, cruise control is activated
- ⓘ The segments between the stored speed and the end of the segment display light up in the speedometer.

System limits

Cruise control may be unable to maintain the stored speed on uphill gradients. The stored speed is resumed when the gradient evens out.

Change into a lower gear in good time on long and steep downhill gradients. Take particular note of this when driving a laden vehicle. By

doing so, you will make use of the engine's braking effect. This relieves the load on the brake system and prevents the brakes from overheating and wearing too quickly.

Do not use cruise control in the following situations:

- In traffic situations which require frequent changes of speed, e.g. in heavy traffic, on winding roads.
- On slippery roads. Accelerating can cause the drive wheels to lose traction and the vehicle could then skid.
- If you are driving when visibility is poor.

Operating cruise control

⚠ WARNING Risk of accident due to stored speed

If you call up the stored speed and this is lower than your current speed, the vehicle decelerates.

- ▶ Take into account the traffic situation before calling up the stored speed.

Requirements:

- ESP® must be activated, but not intervening.
- The driven speed is at least 19 mph (30 km/h).
- The transmission is in position **D**.

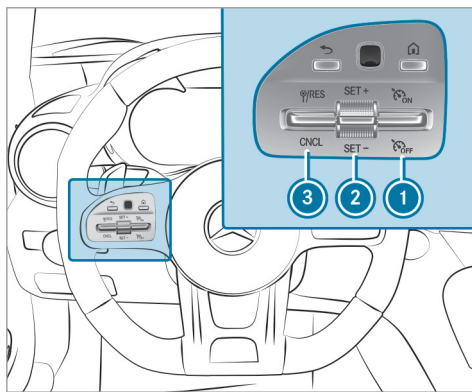

- ▶ **To activate cruise control:** press rocker switch **1** up.

- ▶ **To activate cruise control:** press rocker switch **2** up (SET+) or down (SET-). The current speed is stored and maintained by the vehicle.

or

- ▶ Press rocker switch **3** up (RES). The last stored speed is called up and maintained by the vehicle. If the last stored speed has previously been deleted, the currently driven speed is stored.

i When you switch off the vehicle, the last speed stored is cleared.

- ▶ **To increase/reduce speed:** press rocker switch **2** up (SET+) or down (SET-) to the pressure point. The stored speed is increased or reduced by 1 mph (1 km/h).

or

- ▶ Press rocker switch **2** up (SET+) or down (SET-) beyond the pressure point. The stored speed is increased or reduced by 5 mph (10 km/h).

or

- ▶ Accelerate the vehicle to the desired speed.
 - ▶ Press rocker switch ② up (SET+).
 - ▶ **To deactivate cruise control:** press rocker switch ③ down (CNCL).
 - ▶ **To deactivate cruise control:** press rocker switch ① down.
- ⓘ If you brake, deactivate ESP® or if ESP® intervenes, cruise control is deactivated.

Active Distance Assist DISTRONIC

Function of Active Distance Assist DISTRONIC

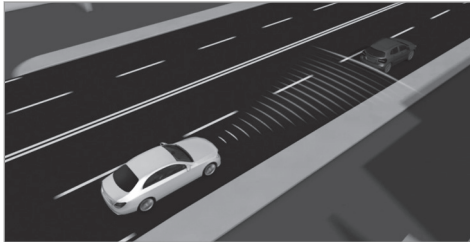

Active Distance Assist DISTRONIC maintains the set speed on free-flowing roads. If vehicles in front are detected, the set distance is maintained, if necessary, until the vehicle comes to a halt. The vehicle accelerates or brakes depending on the distance to the vehicle in front and the set speed. The speed (in the range between 19 mph (30 km/h) and 120 mph (200 km/h)) and the distance to the vehicle in front are set and saved on the steering wheel.

Other features of Active Distance Assist DISTRONIC:

- Adjusts the driving style depending on the selected drive program (fuel efficient, comfortable or dynamic) (→ page 121)
- Initiates acceleration to the stored speed if the turn signal indicator is switched on to change to the overtaking lane.

Active Distance Assist DISTRONIC is only an aid. The driver is responsible for keeping a safe distance to the vehicle in front, for vehicle speed and for braking in good time.

System limits

The system may be impaired or may not function in the following situations:

- In snow, rain, fog, heavy spray, if there is glare, in direct sunlight or in greatly varying ambient light.
- The windshield in the area of the camera is dirty, fogged up, damaged or covered.
- If the radar sensors are dirty or covered.
- In parking garages or on roads with steep uphill or downhill gradients.
- If there are narrow vehicles in front, such as bicycles or motorcycles.

In addition, on slippery roads, braking or accelerating can cause one or several wheels to lose traction and the vehicle could then skid.

Do not use Active Distance Assist DISTRONIC in these situations.

⚠ WARNING Risk of accident from acceleration or braking by Active Distance Assist DISTRONIC

Active Distance Assist DISTRONIC may accelerate or brake in the following cases, for example:

- If the vehicle pulls away using Active Distance Assist DISTRONIC.
- If the stored speed is called up and is considerably faster or slower than the currently driven speed.
- If Active Distance Assist DISTRONIC no longer detects a vehicle in front or does not react to relevant objects.

▶ Always carefully observe the traffic conditions and be ready to brake at all times.

▶ Take into account the traffic situation before calling up the stored speed.

⚠ WARNING Risk of accident due to insufficient deceleration by Active Distance Assist DISTRONIC

Active Distance Assist DISTRONIC brakes your vehicle with up to 50% of the maximum possible deceleration. If this deceleration is not sufficient, Active Distance Assist DISTRONIC alerts you with a visual and acoustic warning.

▶ In these cases, adjust your speed and keep a sufficient distance.

▶ Brake the vehicle yourself and/or take evasive action.

⚠ WARNING Risk of accident if detection function of Active Distance Assist DISTRONIC is impaired

Active Distance Assist DISTRONIC does not react or has a limited reaction:

- when driving on a different lane or when changing lanes

- to pedestrians, animals, bicycles or stationary vehicles, or unexpected obstacles
- to complex traffic conditions
- to oncoming vehicles and crossing traffic

As a result, Active Distance Assist DISTRONIC may neither give warnings nor intervene in such situations.

▶ Always observe the traffic conditions carefully and react accordingly.

Operating Active Distance Assist DISTRONIC Requirements:

- The vehicle has been started.
- The electric parking brake is released.
- ESP® is activated and is not intervening.
- The transmission is in position **[D]**.
- All the doors are closed.
- The check of the radar sensor system has been successfully completed (vehicle traveling faster than 12 mph (20 km/h))

- Parking Assist PARKTRONIC is not being used to park the vehicle or to exit from a parking space.
- The vehicle does not skid.

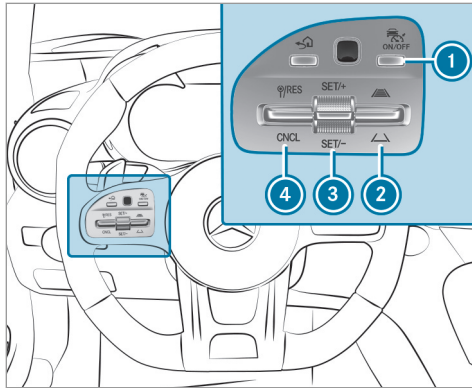

- ▶ **To activate/deactivate Active Distance Assist DISTRONIC:** press button ①.
- ▶ **To activate Active Distance Assist DISTRONIC:** press rocker switch ③ up (SET)

+) or down (SET-), or press rocker switch ④ up (RES). Remove your foot from the accelerator pedal. The current speed is stored and maintained by the vehicle.

or

- ▶ **To activate Active Distance Assist DISTRONIC with a stored speed:** press rocker switch ④ up (RES). Remove your foot from the accelerator pedal.
- ▶ **To pull away with Active Distance Assist DISTRONIC:** remove your foot from the brake pedal and activate Active Distance Assist DISTRONIC.
- ▶ Press rocker switch ④ up (RES).

or

- ▶ Depress the accelerator pedal briefly and firmly. The functions of Active Distance Assist DISTRONIC continue to be carried out.

⚠ WARNING Risk of accident due to Active Distance Assist DISTRONIC still being activated when you leave the driver's seat

If you leave the driver's seat while the vehicle is being braked by Active Distance Assist DISTRONIC only, the vehicle can roll away.

- ▶ Always deactivate Active Distance Assist DISTRONIC and secure the vehicle to prevent it from rolling away before you leave the driver's seat.

- ▶ **To deactivate Active Distance Assist DISTRONIC:** press rocker switch ④ down (CNCL).
- ▶ **To increase/reduce speed:** press rocker switch ③ up (SET+) or down (SET-) to the pressure point. The stored speed is increased or reduced by 1 mph (1 km/h).

or

▶ Press rocker switch ③ up (SET+) or down (SET-) to the pressure point and hold. The stored speed is increased or reduced in increments of 1 mph (1 km/h).

or

▶ Press rocker switch ③ up (SET+) or down (SET-) beyond the pressure point. The stored speed is increased or reduced by 5 mph (10 km/h).

or

▶ Press rocker switch ③ up (SET+) or down (SET-) and hold beyond the pressure point. The stored speed is increased or reduced in increments of 5 mph (10 km/h).

▶ **To increase or reduce the specified distance from the vehicle in front:** press rocker switch ② up or down.

Overview of Active Distance Assist DISTRONIC displays in the instrument cluster

Assistant display

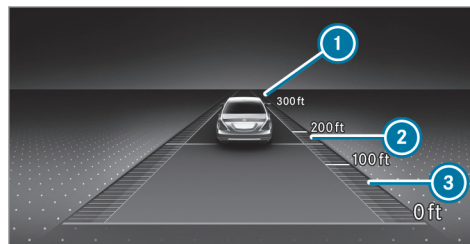

- ① Vehicle in front
- ② Distance indicator
- ③ Set specified distance

Active Distance Assist DISTRONIC status display

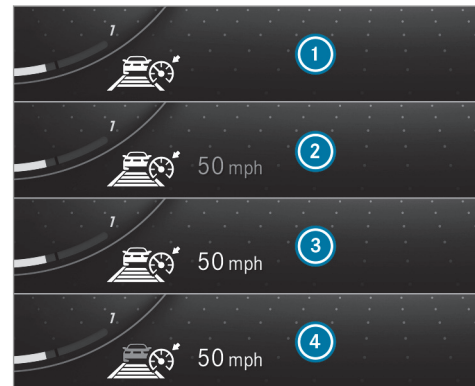

- ① Active Distance Assist DISTRONIC selected, set specified distance (number of segments below the vehicle)
- ② Active Distance Assist DISTRONIC deactivated, speed stored

- ③ Active Distance Assist DISTRONIC active, speed stored, no vehicle detected (gray vehicle symbol)
- ④ Active Distance Assist DISTRONIC active, speed stored, vehicle detected (green vehicle symbol)

Speedometer

The stored speed is highlighted on the speedometer. If the speed of the vehicle in front is less than the stored speed, the segments in the speedometer light up. The deactivation of Active Distance Assist DISTRONIC, as well as alterations to the stored speed and the distance to be maintained, are displayed in the control feedback of the multifunction display on a single line.

Function of Hill Start Assist

Hill Start Assist holds the vehicle for a short time when pulling away on a hill under the following conditions:

- The transmission is in position **D** or **R**.
- The electric parking brake is released.

This gives you enough time to move your foot from the brake pedal to the accelerator pedal and depress it before the vehicle begins to roll away.

⚠ WARNING Risk of accident and injury due to the vehicle rolling away

After a short time, Hill Start Assist no longer holds the vehicle and it can roll away.

- ▶ Therefore, swiftly move your foot from the brake pedal to the accelerator pedal. Never attempt to leave the vehicle if it is being held by Hill Start Assist.

HOLD function

HOLD function

The HOLD function holds the vehicle at a standstill without requiring you to depress the brake pedal, e.g. while waiting in traffic.

The HOLD function is only an aid. The responsibility for the vehicle safely standing still remains with the driver.

System limits

The HOLD function is only intended to provide assistance when driving and is not a sufficient means of safeguarding the vehicle against rolling away when stationary.

- The incline must not be greater than 30%.

Activating/deactivating the HOLD function

⚠ WARNING Risk of an accident due to the HOLD function being activated when you leave the vehicle

If you leave the vehicle while only the HOLD function is braking the vehicle, the vehicle can roll away in the following situations:

- If there is a malfunction in the system or in the power supply.
- If the HOLD function is deactivated by depressing the accelerator pedal or brake pedal, e.g. by a vehicle occupant.

- ▶ Always deactivate the HOLD function and secure the vehicle against rolling away before leaving the vehicle.

! NOTE Damage from automatic braking

If one of the following functions is switched on, the vehicle brakes automatically in certain situations:

- Active Brake Assist
- Active Distance Assist DISTRONIC
- HOLD function
- Active Parking Assist

To avoid damage to the vehicle, deactivate these systems in the following or similar situations:

- ▶ During towing
- ▶ In a car wash

Requirements:

- The vehicle is stationary.
- The driver's door is closed or the seat belt on the driver's side is fastened.
- The engine is running or has been automatically switched off by the ECO start/stop function.

- The electric parking brake is released.
- Active Distance Assist DISTRONIC is deactivated.
- The transmission is in position **D**, **R** or **N**.

Activating the HOLD function

- ▶ Depress the brake pedal and after a short time quickly depress further until the **HOLD** display appears in the multifunction display.
- ▶ Release the brake pedal.

Deactivating the HOLD function

- ▶ Depress the accelerator pedal to pull away.
- or
- ▶ Depress the brake pedal until the **HOLD** display disappears from the multifunction display.

The HOLD function is deactivated in the following situations:

- Active Distance Assist DISTRONIC is activated.
- The transmission is switched to position **P**.

- The vehicle is secured with the electric parking brake.

In the following situations, the vehicle is held by the transmission position **P** or by the electric parking brake:

- The seat belt is unfastened and the driver's door is opened.
- The vehicle is switched off.
- There is a malfunction in the system or the power supply is insufficient.

RACE START**Function of RACE START**

RACE START enables optimal vehicle acceleration from a standstill. For this, a suitably high-grip road surface is required, the tires and vehicle must also be in good condition.

- ⓘ RACE START is only available after the vehicle has been broken in (→ page 111).

- ❗ RACE START may not be used on normal roads. RACE START must only be activated and used on dedicated race circuits, not on public roads. Be sure to read the safety notes and information on ESP® (→ page 140).

⚠ WARNING Risk of skidding and having an accident from wheels spinning

When you use RACE START, individual wheels could spin and you could lose control of the vehicle.

Depending on the ESP® mode selected, there is an increased risk of skidding and having an accident.

- ▶ Make sure that no persons or obstacles are in the close vicinity of your vehicle.

Activating RACE START Requirements:

- The doors, the hood and the trunk lid are closed.
- The engine is running and the transmission and engine are at normal operating temperature.
- The steering wheel is in the straight-ahead position.
- The vehicle is on level ground.
- The vehicle is stationary, the brake pedal is depressed (left foot) and the parking brake is released.
- The transmission is in position **D**.
- One of the drive programs **S**, **S'** or **□** is selected (→ page 121).
- ▶ Rapidly depress the accelerator pedal fully. The engine speed increases.
- ❗ If the activation conditions are not fulfilled, RACE START cannot be activated. The **RACE START Not Possible See Operator's Manual** message appears in the multifunction display.
- ▶ The **RACE START Release brake to start** message appears in the multifunction display.
- ❗ In this phase you can adjust RACE START depending on the road conditions: you can vary the engine speed by pulling on one of the steering wheel paddle shifters. The segments in the multifunction display flicker rapidly.
- ❗ If the brake pedal is not released after a short while, RACE START is canceled. The **RACE START Canceled** message appears in the multifunction display.
- ▶ Take your foot off the brake, but keep the accelerator pedal depressed. The vehicle pulls away at maximum acceleration. The **RACE START Active** message appears in the multifunction display.

RACE START is deactivated when the vehicle reaches a speed of approximately 31 mph (50 km/h).

RACE START is deactivated immediately if you release the accelerator pedal during RACE START or if any of the activation conditions are no longer fulfilled. The **RACE START Canceled** message appears in the multifunction display.

- After using it several times in short succession, RACE START is unavailable until a certain distance has been driven.

Traction control

Function of traction control

⚠ WARNING Risk of skidding if ESP® is deactivated

If you deactivate ESP®, ESP® cannot carry out vehicle stabilization.

- ESP® should only be deactivated in the following situations.

Adjustable traction control is used to enhance performance on a race track and is only activated when ESP® is deactivated. You can adjust the level of assistance from traction control and, in doing so, adjust the balance between stability and agility gradually while accelerating.

Traction control supports you only in metering the engine output. As ESP® is deactivated, ESP®

does not stabilize the vehicle if the vehicle starts to skid.

- Deactivating ESP® and using adjustable traction control requires a highly qualified and experienced driver.

Adjustable traction control may not be used on normal roads. Adjustable traction control may only be activated and used on dedicated race circuits, not on public roads. Be sure to read the safety notes and information on ESP® (→ page 140).

Adjusting traction control Requirements:

- ESP® is deactivated. The  and **ESP OFF** warning lamps light up in the instrument cluster (→ page 142).

You can adjust the level of assistance from traction control and, in doing so, adjust the balance between stability and agility gradually while accelerating.

Take the following parameters into account:

- current road conditions
- type of tire used

- road characteristics
- tire condition, such as temperature or wear
- personal driving style

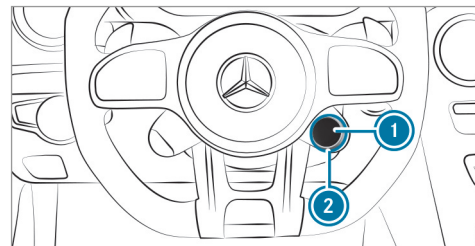

Display button **1** shows the current traction control level with an LED segment display.

- To increase or reduce the level of assistance from traction control, turn control **2** clockwise or counter-clockwise.

Display button **1** and the instrument cluster show the set level.

If the display button shows level **1** with only one LED segment lit up, traction control is deactivated (OFF). If level **9** is shown and all

LED segments light up, traction control is providing the maximum level of assistance (ON).

If you activate ESP®, the level of assistance from traction control is controlled automatically. Display button ❶ then shows the current drive program.

Function of the AMG steering-wheel buttons

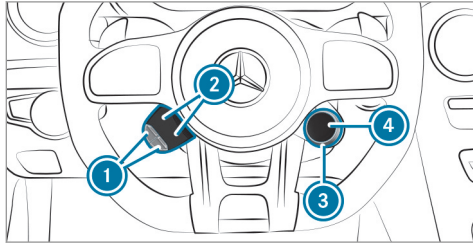

The AMG steering-wheel buttons include two additional control elements on the steering wheel.

You can assign two vehicle functions of your choice to the left control element. You can change between the available functions by pressing display buttons ❷ repeatedly. The currently selected functions are displayed in display buttons ❷.

The following functions are available:

- ESP® (→ page 140)
- AMG adaptive sport suspension system (→ page 157)
- AMG Performance exhaust system (→ page 116)
- ECO start/stop function (→ page 115)
- Manual gearshifting (→ page 126)
- Front and rear view camera (→ page 161)

If you have assigned a function to one of display buttons ❷, you can operate this function with corresponding button ❶.

The assignment of display buttons ❷ remains stored even after a new engine start, but the operating status of the respective function is reset to the basic setting.

You can change between the drive programs with stabilizer bar actuator ❸. The selected drive program appears in display button ❹. By pressing display button ❹, you can directly access the drive program  (Individual) (→ page 121).

If adjustable traction control is activated, set power assistance in increments using stabilizer bar actuator ❸ (→ page 154).

Rear wing

Adjusting the fixed rear wing Requirements

A socket wrench and a releasable, medium-strength bolt lock are to hand.

The rear wing improves the rear axle output and, therefore, the vehicle's driving stability. You can move the rear wing into an inclined and a flat position.

When you move the rear wing into the inclined position, the rear axle output and the air resistance increase.

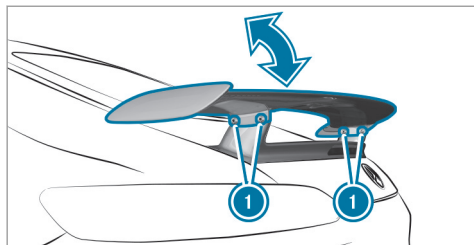

- ▶ Unscrew bolts ① with a socket wrench.
- ▶ Tilt the rear wing as far as it will go, upwards into an inclined position, or downwards into a flat position.
- ▶ Equip bolts ① with a releasable, medium-strength bolt lock and tighten them.
Specified tightening torque: 7.5 lb-ft (10 Nm).

Active aerodynamics profile

Function of the active aerodynamics profile

The active aerodynamics profile is located on the underbody of the front section and, together

with the fixed rear wing, optimizes the vehicle's aerodynamics.

Depending on the drive program selected and the driving speed, the active aerodynamics profile will automatically extend or retract.

You can also extend and retract the active aerodynamics profile manually for cleaning (→ page 156).

Extending and retracting the active aerodynamics profile for cleaning

⚠ WARNING Risk of becoming trapped when you retract the active aerodynamics profile manually

When you retract the active aerodynamics profile manually, body parts may become trapped.

- ▶ Ensure that no one is in the movement range of the active aerodynamics profile when you are retracting the active aerodynamics profile.
- ▶ If someone becomes trapped during retraction of the active aerodynamics

profile, press the display button again immediately.

The active aerodynamics profile will then extend again.

Requirements:

- The transmission has been shifted to the park position **[P]**.
- The ignition is switched on.

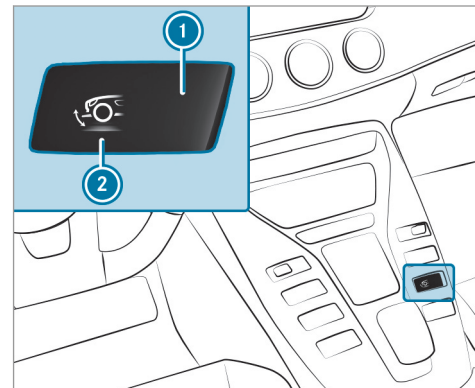

▶ **To extend/retract:** press the display button ①. Note the restricted ground clearance when the active aerodynamics profile is extended.

The active aerodynamics profile extends to its maximum or retracts completely.

Display button symbol ② and its color indicate the following positions of the aerodynamics profile:

- Aerodynamics profile retracted (blue)
- Aerodynamics profile extended in different positions (red)
- Aerodynamics profile is extending or retracting (gray)

If you press display button ① again during the extension process, the aerodynamics profile will retract once more. If you press display button ① again during the retraction process, the aerodynamics profile will extend once more.

- ① If you pull away with the active aerodynamics profile extended, the active aerodynamics profile will automatically retract. Always

note the restricted ground clearance when the active aerodynamics profile is extended.

AMG adaptive sport suspension system

Function of AMG adaptive sport suspension system

AMG adaptive sport suspension system is an electronically controlled damping system for improved driving comfort and increased driving safety.

The damping is adjusted individually to each wheel and depends on the following factors:

- the driving style, e.g. sporty
- the road condition, e.g. bumps
- the individual selection of the drive program: **C** (Comfort), **S** (Sport) or **S+** (Sport+)

- ① The setting can also be set using the DYNAMIC SELECT switch. To do this, the same suspension setting must be selected for AMG adaptive sport suspension system and the DYNAMIC SELECT switch.

- ① When the vehicle is started again, the "Comfort" setting is activated automatically.

Selecting the AMG adaptive sport suspension system setting

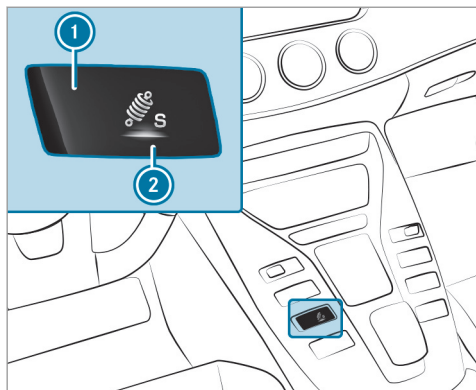

You can select from three different suspension settings:

- **COMFORT** ensures a comfortable suspension setting. Select this suspension setting if you prefer a comfortable driving style.
- **SPORT** ensures a firmer suspension setting. Select this suspension setting when employing a sporty driving style, e.g. on winding country roads.
- **SPORT PLUS** ensures a very firm suspension setting.



▶ Press display button ①.

The display button shows currently selected suspension setting ②:

-  **C** (blue): COMFORT
-  **S** (yellow): SPORT
-  **S+** (red): SPORT PLUS

The selected suspension setting is shown in the multifunction display as a message:

- AMG Suspension System COMFORT
- AMG Suspension System SPORT
- AMG Suspension System SPORT +

Parking Assist PARKTRONIC

Function of Parking Assist PARKTRONIC

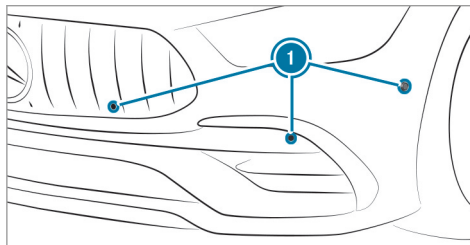

Parking Assist PARKTRONIC is an electronic parking assistance system with ultrasound. It monitors the area around your vehicle using multiple sensors ① on the front bumper and on the rear bumper. Parking Assist PARKTRONIC shows

you the distance between your vehicle and a detected obstacle visually and audibly.

Parking Assist PARKTRONIC is only an aid. It is not a substitute for your attention to the surroundings. The responsibility for safe maneuvering and parking remains with you. Make sure that there are no persons, animals or objects in the maneuvering area while maneuvering and parking in/exiting parking spaces.

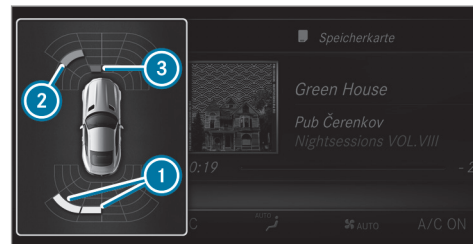

Parking Assist PARKTRONIC warning display (vehicles without front and rear view camera)



Parking Assist PARKTRONIC warning display (vehicles with front and rear view camera)

If Parking Assist PARKTRONIC detects an obstacle in the path of the vehicle, a pop-up window with the appropriate warning display appears in the media display at speeds below approximately 6 mph (10 km/h).

The color segments show the distance between the sensors and the obstacle detected:

- ① **Yellow warning display:** obstacles at a distance of between approx. 2.0 ft (0.6 m) and 3.3 ft (1.0 m)

- ② **Orange warning display:** obstacles at a medium distance between approx. 1.0 ft (0.3 m) and 2.0 ft (0.6 m)
- ③ **Red warning display:** obstacles at a very short distance of approx. 1.0 ft (0.3 m) or less

When Parking Assist PARKTRONIC is operational and no object is detected, no segments are shown in the warning display.

- ① If the entire system fails, the internal segments of the warning display are shown in red and the  symbol appears in the multifunction display in the instrument cluster. If Parking Assist PARKTRONIC is deactivated, the warning display fades out.

In the standard setting, an intermittent warning tone sounds from a distance of approximately 1.0 ft (0.3 m) to an obstacle in front and approximately 3.3 ft (1.0 m) to an obstacle behind. A continuous warning tone sounds from a distance of approximately 0.7 ft (0.2 m). Using the **Warn early** setting, you can set the warning tone in the multimedia system so that it will sound ear-

lier at a greater distance of approximately 3.3 ft (1.0 m) (→ page 160).

- ① The **Warn early** setting is always active at the rear of the vehicle.

System limits

Parking Assist PARKTRONIC does not necessarily take into account the following obstacles:

- Obstacles below the detection range, e.g. persons, animals or objects.
- Obstacles above the detection range, e.g. overhanging loads, overhangs or loading ramps of trucks.

As a result of additional accessories (e.g. license plate bracket or bicycle rack) the actual distance to an obstacle may not correspond to the distance measured by Parking Assist PARKTRONIC under certain conditions.

The sensors must be free of dirt, ice and slush. Otherwise, they may not function correctly. Clean the sensors regularly, taking care not to scratch or damage them.

Activating/deactivating Parking Assist PARKTRONIC

! **NOTE** Risk of an accident from objects at close range

Parking Assist PARKTRONIC may not detect certain objects at close range.

- ▶ When parking or maneuvering the vehicle, pay particular attention to any objects which are above or below the sensors, e.g. flower pots or drawbars. The vehicle or other objects could otherwise be damaged.

If indicator lamp **1** is not lit, Parking Assist PARKTRONIC is active. If the indicator lamp is lit or the  symbol appears in the multifunction display, Parking Assist PARKTRONIC is not active.

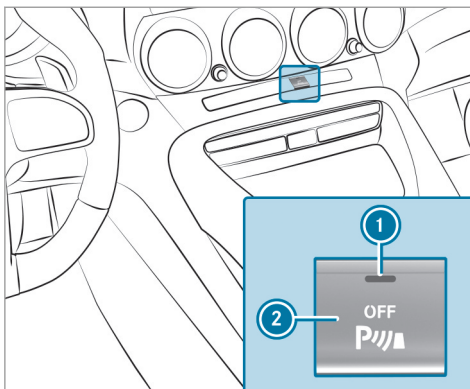

- ▶ Press button **2**.

i Parking Assist PARKTRONIC is automatically activated when the vehicle is started.

Adjusting the warning tones of Parking Assist PARKTRONIC

Multimedia system:

- ▶  Vehicle ▶  Assistance
- ▶ Camera & Parking ▶ Set Warning Tones

Adjusting the volume of the warning tones

- ▶ Select [Warning Tone Volume](#).
- ▶ Set a value.

Adjusting the pitch of the warning tones

- ▶ Select [Warning Tone Pitch](#).
- ▶ Set a value.

Specifying the starting point for the warning tones

You can specify whether the Parking Assist PARKTRONIC warning tones should commence when the vehicle is further away from an obstacle.

- ▶ Select [Warn Early](#).
- ▶ Activate or deactivate the function.

Activating/deactivating audio fadeout

You can specify whether the volume of a media source in the multimedia system is to be reduced when Parking Assist PARKTRONIC gives an audible warning.

- ▶ Select **Audio Fadeout During Warning Tones**.
- ▶ Activate or deactivate the function.

Front and rear view camera

Function of the front camera and rear view camera

The front camera and rear view camera support Parking Assist PARKTRONIC and help you to avoid obstacles when maneuvering.

When automatic operation of the rear view camera is activated in the multimedia system, the image from the rear view camera is shown automatically next to the Parking Assist PARKTRONIC warning display when reverse gear is engaged.

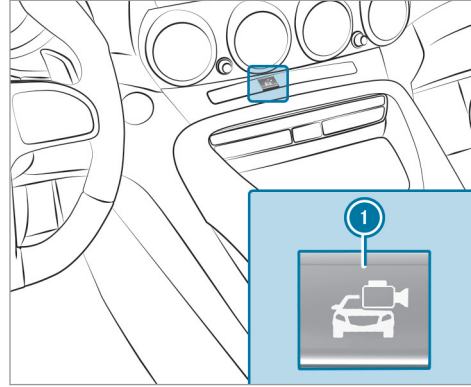

The front camera view can be called up using button ① or using the softkeys in the multimedia system.

- ① You can also switch between the front camera and rear view camera views using the AMG steering-wheel buttons (→ page 155).
- ① If the rear view camera is active and you shift from reverse gear to the drive position,

the view automatically switches from the rear view camera to the front camera.

The front camera and rear view camera are only an aid. They are not a substitute for your attention to the surroundings. The responsibility for safe maneuvering and parking remains with you. Make sure that there are no persons, animals or objects etc., in the maneuvering area while maneuvering and parking.

The area behind the vehicle is displayed as a mirror image, as in the inside rearview mirror.

You can switch between various views in the multimedia system, not just between the front camera and rear view camera.



- ① Front camera, wide-angle view
- ② Front camera, standard view
- ③ Rear view camera, standard view
- ④ Rear view camera, wide-angle view

Dynamic guide lines in the camera image show the path the vehicle will take with the steering wheel in its current position. This helps you to orient yourself and to avoid obstacles when maneuvering.

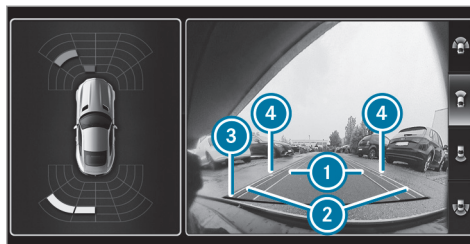

- ① Yellow lane marking the course the tires will take at the current steering wheel angle (dynamic)
- ② Yellow guide line, vehicle width (driven surface) depending on the current steering wheel angle (dynamic)
- ③ Red guide line at a distance of approximately 1 in (0.3 m) from the rear area
- ④ Mark at a distance of approx. 3.3 ft (1.0 m)

The guide lines in the media display show the distances to your vehicle. The distances displayed only apply to road level.

System limits

The cameras will not function or will only partially function in the following situations:

- There is heavy rain, snow or fog.
- The ambient light conditions are poor, e.g. at night.
- The respective camera lens is obstructed, dirty or fogged up. Observe the notes on cleaning the cameras (→ page 307).
- Cameras, or vehicle components in which the cameras are installed, are damaged. In this event, have the cameras, their positions and their setting checked at a qualified specialist workshop.

The field of vision and other functions of the rear view camera may be restricted due to additional accessories (e.g. license plate bracket or bicycle rack).

- ⓘ The display contrast may be impaired due to incident sunlight or other light sources. In this case, pay particular attention.

- ❗ Have the display repaired or replaced if, for example, pixel errors considerably restrict its use.

Switching rear view camera automatic mode on/off

The rear view camera is only an aid. It is not a substitute for your attention to the surroundings. The responsibility for safe maneuvering and parking remains with you. Make sure that no persons, animals or objects etc. are in the maneuvering range. Pay attention to your surroundings and be ready to brake at all times.

Multimedia system:

- ➔ Vehicle ➔  Assistance
- ➔ Camera & Parking ➔ Auto. Rear View Cam.
- ▶ Switch the function on or off .

ATTENTION ASSIST

Function of ATTENTION ASSIST

ATTENTION ASSIST assists you on long, monotonous journeys, e.g. on highways and trunk roads. If ATTENTION ASSIST detects indicators of fati-

gue or increasing lapses in concentration on the part of the driver, it suggests taking a break.

ATTENTION ASSIST is only an aid. It cannot always detect fatigue or lapses in concentration in time. The system is not a substitute for a well-rested and attentive driver. On long journeys, take regular breaks in good time that allow for adequate recuperation.

You can choose between two settings:

- **Standard:** normal system sensitivity.
- **Sensitive:** higher system sensitivity. The driver is warned earlier and the attention level detected by ATTENTION ASSIST is adapted accordingly.

If drowsiness or increasing lapses in concentration are detected, the **ATTENTION ASSIST: Take a Break!** warning appears in the Instrument Display. You can acknowledge the message and take a break where necessary. If you do not take a break and ATTENTION ASSIST continues to detect increasing lapses in concentration, you will be warned again after a minimum of 15 minutes.

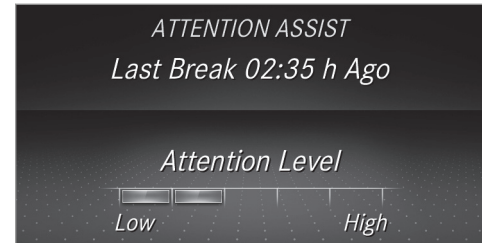

You can have the following status information for ATTENTION ASSIST displayed in the assistance menu of the on-board computer:

- The length of the journey since the last break.
- The attention level determined by ATTENTION ASSIST.

If ATTENTION ASSIST is unable to calculate the attention level and cannot issue a warning, the **System Suspended** message appears.

If a warning is given in the Instrument Display, the multimedia system offers to search for a rest area. You can select a rest area and start naviga-

tion to this rest area. This function can be activated and deactivated in the multimedia system.

If ATTENTION ASSIST is deactivated, the  symbol appears in the assistance graphic in the Instrument Display when the engine is running. ATTENTION ASSIST is activated automatically when the engine is re-started. The last selected sensitivity level remains stored.

System limits

ATTENTION ASSIST is active in the 37 mph (60 km/h) to 124 mph (200 km/h) speed range.

The functionality of ATTENTION ASSIST is restricted, and warnings may be delayed or not occur at all in the following situations:

- If you have been driving for less than approximately 30 minutes.
- If the road condition is poor (uneven road surface or potholes).
- If there is a strong side wind.
- If you adopt a sporty driving style (high cornering speeds or high rates of acceleration).
- If the time has been set incorrectly.

- In active driving situations, if you change lanes and vary your speed frequently.

The ATTENTION ASSIST tiredness or alertness assessment is deleted and restarted when continuing the journey in the following situations:

- If you switch off the engine.
- If you unfasten your seat belt and open the driver's door (e.g. changing drivers or taking a break).

Setting ATTENTION ASSIST

Multimedia system:

- ➔ Vehicle ➔  Assistance
- ➔ ATTENTION ASSIST

Setting options

- ▶ Select **Standard**, **Sensitive** or **Off**.

Suggesting a rest area

- ▶ Select **Suggest Rest Area**.
- ▶ Activate or deactivate the function . If ATTENTION ASSIST detects fatigue or increasing lack of attention, it suggests a rest area in the vicinity.

- ▶ **Select a suggested rest area:** you are guided to the selected rest area.

Traffic Sign Assist

Function of Traffic Sign Assist

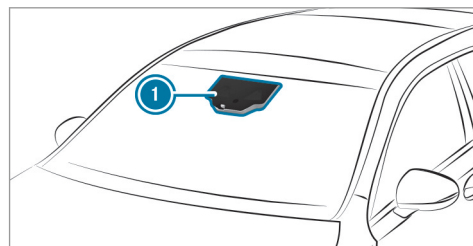

Traffic Sign Assist detects traffic signs with multifunction camera ①. It assists you by displaying detected speed limits and overtaking restrictions in the instrument cluster.

Since Traffic Sign Assist also uses the data stored in the navigation system, it can update the display in the following situations without detecting traffic signs:

- When the vehicle changes roads, e.g. on a freeway entry or exit road.
- When a village or city boundary which is stored in the digital map is passed.

The camera also detects traffic signs with a restriction indicated by an additional sign (e.g. in wet conditions).

- ① Traffic signs are only displayed with the restriction indicated by an additional sign in the following cases:
- The traffic signs must be observed with the restriction.
 - The system is unable to clearly determine whether the restriction applies.

Traffic Sign Assist is only an aid. The driver is responsible for keeping a safe distance from the vehicle in front, for vehicle speed and for braking in good time.

Warning when the maximum permissible speed is exceeded

The system can warn you if you unintentionally exceed the maximum permissible speed. To do this, you can specify in the multimedia system by how much the maximum permissible speed can be exceeded before a warning is issued. You can specify whether the warning is to be just a visual warning or an acoustic one as well.

Display in the Instrument Display

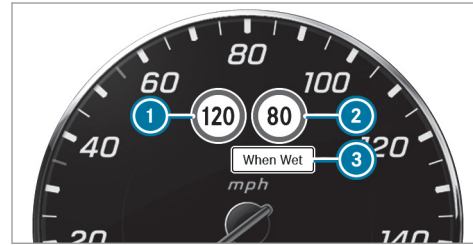

Instrument Display in the Widescreen Cockpit

- ① Permissible speed
- ② Permissible speed when there is a restriction
- ③ Additional sign with restriction



Traffic Sign Assist is not available in all countries. If it is unavailable, display ① is shown in the speedometer.

- ① If Traffic Sign Assist is unable to determine a maximum speed from any of the available sources, no speed limit is displayed in the instrument cluster.

System limits

The system may be impaired or may not function in the following situations:

- If there is poor visibility, e.g. due to insufficient illumination of the road, if there are highly variable shade conditions or in rain, snow, fog or heavy spray.

- If there is glare, e.g. from oncoming traffic, direct sunlight or reflections.
- If the windshield in the area of the multifunction camera is dirty, or if the camera is fogged up, damaged or covered.
- If the traffic signs are hard to detect, e.g. due to dirt or snow, or because they are covered or due to insufficient lighting.
- If the information in the navigation system's digital map is incorrect or out-of-date.
- If the signs are ambiguous, e.g. traffic signs on construction sites or in adjacent lanes.
- If you turn sharply, when passing traffic signs outside the camera's field of vision.

Setting Traffic Sign Assist

Multimedia system:

→ Vehicle →  Assistance
→ Traffic Sign Assist

Displaying detected traffic signs in the media display

- ▶ Select **Display in COMAND**.
- ▶ Activate or deactivate the function.

Blind Spot Assist

Function of Blind Spot Assist

At speeds above approximately 18 mph (30 km/h), Blind Spot Assist uses two lateral, rear-facing radar sensors to monitor the area up to 10 ft (3 m) behind your vehicle and directly next to your vehicle. Below 18 mph (30 km/h), the system is not active and vehicles in the monitoring range are not detected.

If Blind Spot Assist is activated, the warning lamp in the outside mirror lights up yellow at speeds of up to 18 mph (30 km/h). At speeds above approximately 18 mph (30 km/h), the warning lamp goes out and Blind Spot Assist is operational.

If a vehicle is detected within the monitoring range at speeds above 18 mph (30 km/h), the warning lamp in the outside mirror lights up red.

If a vehicle is detected close to your vehicle in the lateral monitoring range and you switch on the turn signal indicator in the corresponding direction, a warning tone sounds once and the warning lamp in the outside mirror flashes red. If the turn signal indicator remains switched on, all

other detected vehicles are indicated only by the flashing of the red warning lamp.

If you overtake a vehicle quickly, no warning is given.

WARNING Risk of accident despite Blind Spot Assist

Blind Spot Assist does not react to vehicles approaching and overtaking you at a greatly different speed.

As a result, Blind Spot Assist cannot warn drivers in this situation.

- ▶ Always pay careful attention to the traffic situation and maintain a safe distance at the side of the vehicle.

Blind Spot Assist is only an aid. It may fail to detect some vehicles and is not a substitute for attentive driving. Always ensure that there is sufficient distance to the side for other road users and obstacles.

System limits

The system may be limited in the following situations:

- The sensors are dirty or covered.
- Poor visibility, e.g. due to fog, heavy rain, snow or spray.
- Narrow vehicles, e.g. bicycles, are within the monitoring range.
- If the lanes are very narrow or very wide, especially if vehicles are not driving in the middle of their lane.

Warnings may be issued in error when driving close to crash barriers or similar solid lane borders. Warnings may be interrupted when driving alongside long vehicles, for example trucks, for a prolonged time.

Blind Spot Assist is not operational when reverse gear is engaged.

Activating/deactivating Blind Spot Assist or Active Blind Spot Assist

Multimedia system:

→ Vehicle ▶ Assistance

▶ Blind Spot Assist

▶ Activate or deactivate the function.

Lane Keeping Assist

Function of Lane Keeping Assist

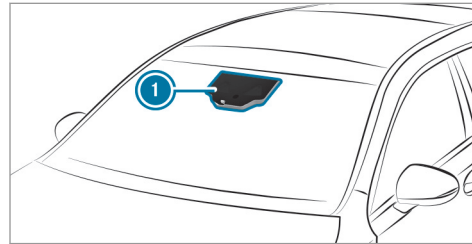

Lane Keeping Assist monitors the area in front of your vehicle by means of multifunction camera ❶. It serves to protect you against unintention-

ally leaving your lane. You will be warned by means of a vibration in the steering wheel.

You are warned by vibration pulses in the steering wheel in the following circumstances:

- Lane Keeping Assist detects lane markings.
- A front wheel passes over the lane markings.

Whether a warning is issued and when this occurs also depends on the selected sensitivity setting (standard or adaptive).

Lane Keeping Assist can neither reduce the risk of an accident if you fail to adapt your driving style nor override the laws of physics. It cannot take into account road, weather or traffic conditions. Lane Keeping Assist is only an aid. You are responsible for the distance to the vehicle in front, for vehicle speed, for braking in good time and for staying in your lane.

Lane Keeping Assist is available in the speed range between 40 mph (60 km/h) and 120 mph (200 km/h).

System limitations

The system may be impaired or may not function in the following situations:

- If there is poor visibility, e.g. due to insufficient illumination of the road, if there are highly variable shade conditions or in rain, snow, fog or heavy spray.
- If there is glare, e.g. from oncoming traffic, the sun or reflections.
- If the windshield in the area of the multifunction camera is dirty, or if the camera is fogged up, damaged or covered.
- If there are no lane markings, or several unclear lane markings are present for one lane, e.g. around roadworks.
- If the lane markings are worn, dark or covered.
- If the distance to the vehicle in front is too short and thus the lane markings cannot be detected.
- If the lane markings change quickly, e.g. lanes branch off, cross one another or merge.

- If the roadway is very narrow and winding.

Sensitivity of Lane Keeping Assist

With the Standard or Adaptive setting, you can influence when the warning vibration of Lane Keeping Assist takes place.

In both the Standard and Adaptive settings, no warning vibration occurs in the following situations:

- You have switched on the turn signal indicator.
- A driving safety system intervenes, such as ABS, BAS or ESP®.

In the Adaptive setting, there will also be no warning vibration in the following situations:

- The vehicle is accelerated or braked considerably.
- You steer actively, e.g. swerve to avoid an obstacle or change lane quickly.
- You cut the corner on a sharp bend.

Vehicle towing instructions

The vehicle is not suitable for the use of tow bar systems that are used for flat towing or dinghy towing, for example. Attaching and using tow bar systems can lead to damage on the vehicle. When you are towing a vehicle with tow bar systems, safe driving characteristics cannot be guaranteed for the towing vehicle or the towed vehicle. The vehicle-trailer combination may swerve from side to side. Comply with the permitted towing methods (→ page 324) and the instructions for towing with both axles on the ground (→ page 325).

Instrument Display overview

⚠ WARNING Risk of accident due to an instrument display malfunction

If the Instrument Display has failed or malfunctioned, you may not recognize function restrictions applying to safety relevant systems.

The operating safety of your vehicle may be impaired.

- ▶ Drive on carefully.
- ▶ Have the vehicle checked immediately at a qualified specialist workshop.

If the operating safety of your vehicle is impaired, park the vehicle immediately and safely. Contact a qualified specialist workshop.

Instrument Display in the Widescreen Cockpit

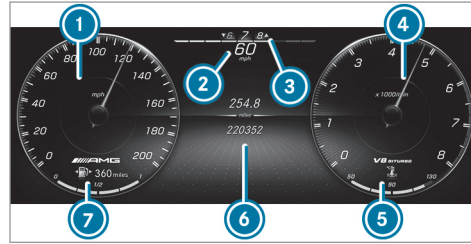

- ① Speedometer
 - ② Digital speedometer
 - ③ Gear display
 - ④ Example: area for additional values
 - ⑤ Coolant temperature display
 - ⑥ Multifunction display
 - ⑦ Fuel level and fuel filler flap location indicator
- i** Further display content can be shown on display ④ for additional values (→ page 172).

The segments on speedometer ① indicate the system status for the following:

- Cruise control (→ page 145)
- Active Distance Assist DISTRONIC (→ page 147)

! NOTE Engine damage due to excessively high engine speeds

The engine will be damaged if you drive with the engine in the overrevving range.

- ▶ Do not drive with the engine in the overrevving range.

The fuel supply will be interrupted to protect the engine when the red mark on the tachometer (overrevving range) is reached.

During normal operating conditions, coolant temperature display ⑤ may rise to the red mark.





⚠ WARNING Danger of burns when opening the hood

If you open the hood when the engine has overheated or during a fire in the engine compartment, you could come into contact with hot gases or other escaping operating fluids.

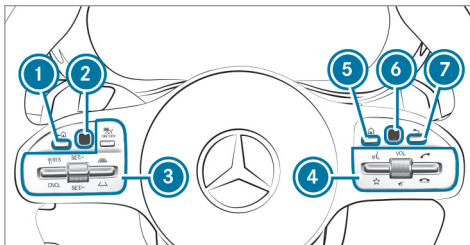

- ▶ Before opening the hood, allow the engine to cool down.
- ▶ In the event of a fire in the engine compartment, keep the hood closed and call the fire service.

Overview of the buttons on the steering wheel



- ①  Back/Home button (press and hold), on-board computer
- ② Touch Control, on-board computer
- ③ Control panel for cruise control or Active Distance Assist DISTRONIC
- ④ Control panel for multimedia system:
 -  Voice Control System
 -  Displays favorites
 - VOL: control knob, adjusts the volume or switches the sound off  (press)
 -  Makes/accepts a call

 Rejects/ends a call

- ⑤  Calls up the home screen
- ⑥ Touch Control multimedia system
- ⑦  Back button

Operating the on-board computer

⚠ WARNING Risk of distraction from information systems and communications equipment

If you operate information and communication equipment integrated in the vehicle when driving, you will be distracted from the traffic situation. This could also cause you to lose control of the vehicle.

- ▶ Only operate this equipment when the traffic situation permits.
- ▶ If you cannot be sure of this, stop the vehicle whilst paying attention to road and traffic conditions and operate the equipment with the vehicle stationary.

Observe the legal requirements for the country in which you are currently driving when operating the on-board computer.

- i** The on-board computer displays will appear on the multifunction display (→ page 173).

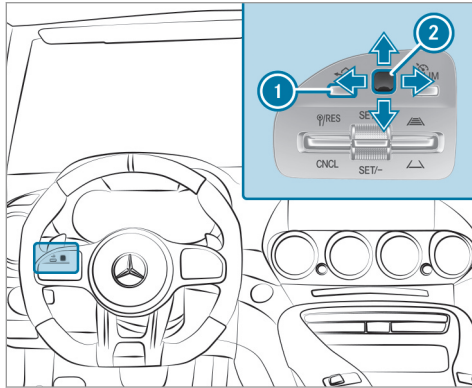

The on-board computer is operated using left-hand Touch Control **2** and the left-hand back/home button **1**.

When the on-board computer is being operated, different acoustic signals will sound as operating feedback, e.g. when the end of a list is reached or when you are scrolling through a list.

The following menus are available:

- Service
- DriveAssist
- Performance
- Trip
- Navigation
- Radio
- Media
- Phone
- Designs

The menus can be called up from the menu bar on the multifunction display.

- ▶ **To call up the menu bar:** press the back button on the left **1** until the menu bar is displayed.

- i** **Vehicles without Active Distance Assist DISTRONIC:** press the  button to call up the menu bar of the on-board computer.



- ▶ **To scroll in the menu bar:** swipe left or right on the left-hand Touch Control **2**.
- ▶ **To call up a menu or confirm a selection:** press left-hand Touch Control **2**.
- ▶ **To scroll through displays or lists on the menu:** swipe upwards or downwards on left-hand Touch Control **2**.
- ▶ **To call up a submenu or confirm a selection:** press left-hand Touch Control **2**.

- ▶ **To exit a submenu:** press back button on the left ①.

Setting the design

On-board computer:

↳ Designs

The following designs can be selected:

- Supersport
- Sport
- Classic

- ▶ **To select a design:** swipe upwards or downwards on the left-hand Touch Control.
- ▶ Press the left-hand Touch Control. The Instrument Display will be shown in the selected design.

Setting the area for additional values



G-meter (example)

- ① Area for additional values
- ② Index points

- ▶ **To select display content:** swipe to the right on the left-hand Touch Control.
- ▶ Swipe upwards or downwards on the left-hand Touch Control to select display content. When display content is selected, area for additional values ① will briefly be highlighted.
- ▶ Index points ② will display the selected list item.

The following content can be displayed in Mercedes-AMG vehicles:

- Tachometer/date
- G-Meter
- Engine data
- AMG TRACK PACE
- Warm-up
- Trip computer
- Navigation

Overview of displays on the multifunction display

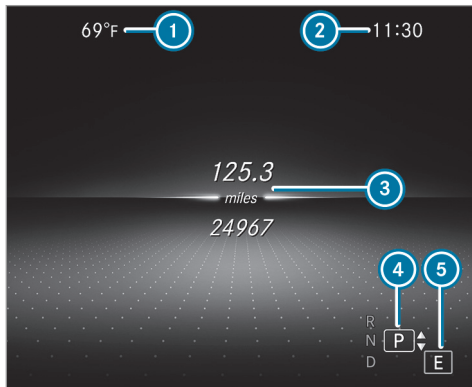

- ① Outside temperature
- ② Time
- ③ Display section
- ④ Transmission position
- ⑤ Drive program

Further displays on the multifunction display:

- ↑ Gearshift recommendation (→ page 126)
- Parking Assist PARKTRONIC deactivated (→ page 160)
- Cruise control (→ page 145)
- Active Distance Assist DISTRONIC (→ page 147)
- Active Brake Assist (→ page 145)
- Lane Keeping Assist (→ page 167)
- ECO start/stop function
- HOLD function (→ page 151)
- Adaptive Highbeam Assist (→ page 97)

Vehicles with Traffic Sign Assist: Detected instructions and traffic signs (→ page 164).

Adjusting the instrument lighting

Multimedia system:

→ Vehicle ▶ Light Settings

▶ Select **Instr. Cluster Lighting**.

- ▶ Set a brightness value.
The brightness of the Instrument Display will be adapted.

Menus and submenus

Calling up functions on the service menu of the on-board computer

On-board computer:

→ Service

- ▶ **To select a function:** swipe upwards or downwards on the left-hand Touch Control.
- ▶ Press the left-hand Touch Control.

Functions on the **Service** menu:

- Message memory (→ page 371)
- **Tires:**
 - Check the tire pressure with the tire pressure monitor (→ page 336)
 - Restart the tire pressure monitor (→ page 337)
- **ASSYST PLUS:** call up the service due date (→ page 295)

- **Vehicles with a Widescreen Cockpit:** **Coolant:** coolant temperature display

Calling up displays on the Assistance menu

On-board computer:

↳ DriveAssist

The following displays are available on the Assistance menu:

- Assistant display
- Attention level (→ page 163)

▶ **To switch between the displays:** swipe upwards or downwards on the left-hand Touch Control.

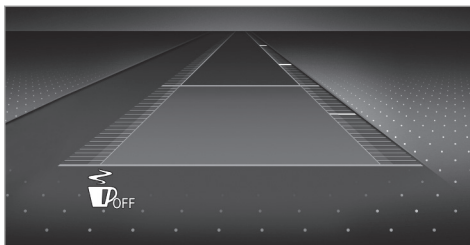

Status displays on the assistant display:

-  ATTENTION ASSIST switched off
- Light lane markings: Lane Keeping Assist enabled
- Green lane markings: Lane Keeping Assist active
- Active Distance Assist DISTRONIC displays (→ page 147)

Calling up displays on the Performance menu

On-board computer:

↳ Performance

▶ **To select a display:** swipe upwards or downwards on the left-hand Touch Control.

Displays on the Performance menu:

- Warm-up
- SETUP
- G-Meter
- Engine data
- **Vehicles without AMG TRACK PACE:** RACE-TIMER (→ page 176)

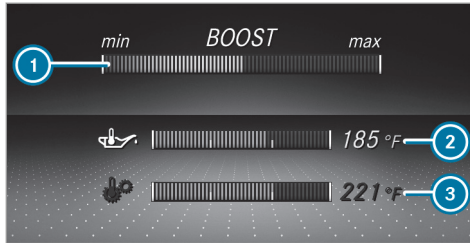

Warm-up (example)

- ① Boost pressure
- ② Engine oil temperature
- ③ Transmission oil temperature

If the engine or transmission is not at normal operating temperature, the multifunction display will show temperature ② or ③ in blue. Avoid using the full engine power output during this time.

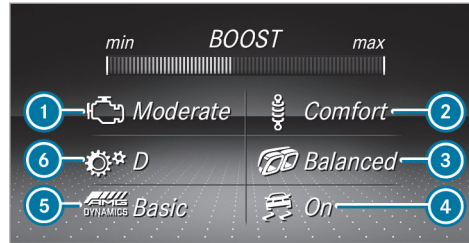

SETUP in Mercedes-AMG GT vehicles (example)

- ① Drive system setting:
Reduced/Moderate/Sport/Dynamic/Race
- ② Suspension tuning:
Comfort/Sport/Sport+
- ③ Exhaust system:
Balanced/Powerful
- ④ ESP®:
On/Sport/Off
- ⑤ AMG Dynamics:
Basic/Advanced/Pro/Master
- ⑥ Transmission position:
D/M

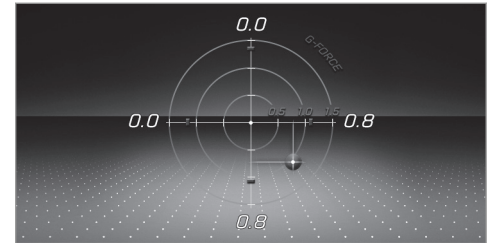

G-meter (example)

While the vehicle is in motion, the G-meter shows the forces that are exerted on the vehicle occupants both laterally and in the direction of travel. The maximum values appear in red in the coordinate system.

- ▶ **To reset the G-meter:** press the left-hand Touch Control.
- ▶ Select **Yes**.
- ▶ Press the left-hand Touch Control.

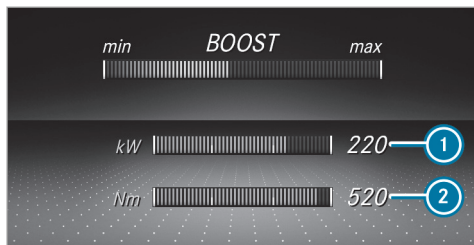

Engine data (example)

- ① Current power output
- ② Current torque

When current power ① or current torque ② achieves the maximum value, the digital value is briefly stationary. The bar display will continue.

Displaying and starting RACE TIMER on the Performance menu

On-board computer:

↳ Performance

The following functions are possible in the RACE TIMER:

- Selecting displays and starting
- Stopping
- Starting a new lap
- Displaying lap statistics
- Resetting

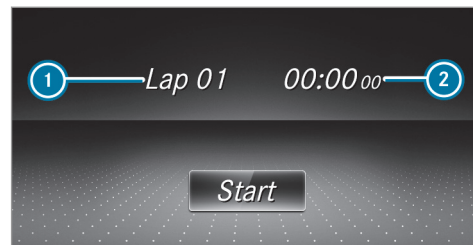

- ① Lap
- ② Lap time

RACE TIMER is intended only for use on designated race tracks. Do not use the function on public roads.

- ▶ **To select a display and start:** swipe up or down on the left-hand Touch Control.
- ▶ Press the left-hand Touch Control.
- ▶ Select **Start** and press the left-hand Touch Control.
- ▶ **To stop:** select **Stop** and press the left-hand Touch Control.

- ▶ **To start a new lap:** after the first stored lap, press the left-hand Touch Control.
- ▶ Select **New Lap**.
A maximum of 32 laps may be stored.



Example: RACE TIMER

- ① Lap
 - ② Elapsed time
 - ③ Average speed
 - ④ Distance covered
- ▶ **To display the lap statistics:** after at least two stored laps, press the left-hand Touch Control.

- ▶ Select **Lap List**.
The lap statistics will be displayed.
- ▶ Display the statistics for the next lap by swiping up or down on the left-hand Touch Control.
The fastest lap is indicated by flashing text ①.
- ▶ **To reset:** stop RACE TIMER and press the left-hand Touch Control.
- ▶ Select **Reset** and press the left-hand Touch Control.
All laps will be deleted.

Calling up displays on the Trip menu

On-board computer:

↳ Trip

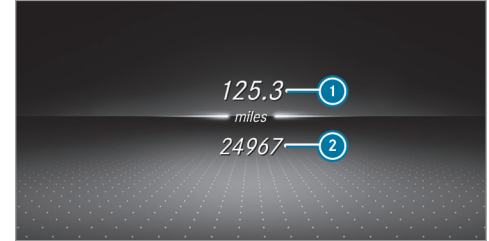

Standard display (example)

- ① Trip distance
- ② Total distance

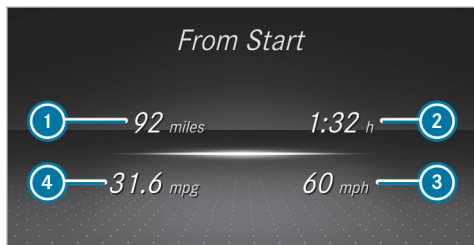

Trip computer (example)

- ① Total distance
- ② Driving time
- ③ Average speed
- ④ Average fuel consumption

① You can view information about the journey in the left-hand area of the Instrument Display.

▶ **To select a display:** swipe upwards or downwards on the left-hand Touch Control.

Displays on the **Trip** menu:

- Standard display
- Range and current fuel consumption

If there is only a small amount of fuel left in the fuel tank, the display will show a vehicle being refueled instead of the range.

- Trip computer **From Start** and **From Reset**
- Digital speedometer

Resetting values on the Trip menu of the on-board computer

On-board computer:

↳ Trip

① The spelling on the main menu displayed may differ. Therefore, observe the menu overview for the instrument display (→ page 170).

You can reset the values of the following functions:

- Trip distance
- Trip computer **From Start** and **From Reset**

▶ **To select the function to be reset:** swipe upwards or downwards on the left-hand Touch Control.

- ▶ Press the left-hand Touch Control.
- ▶ Select **Yes**.
- ▶ Press the left-hand Touch Control.

If you press and hold the left-hand Touch Control, the values of the function will be reset immediately.

Calling up navigation instructions on the on-board computer

On-board computer:

→ Navigation



Example: no change of direction announced

- ① Distance to the next change of direction
- ② Distance to the next destination
- ③ Estimated arrival time at next destination
- ④ Current road

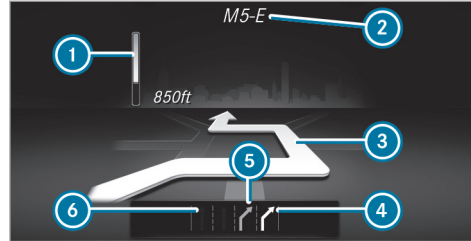

Example: change of direction announced

- ① Distance to the change of direction
- ② Road to which the change of direction leads
- ③ Change-of-direction symbol
- ④ Recommended lane (white)
- ⑤ Possible lane
- ⑥ Lane not recommended (dark gray)

Further possible displays on the **Navigation** menu:

- **Direction of Travel:** display of direction of travel and road currently being traveled on.
- **New Route...** or **Calculating Route...**: a new route is being calculated.

- **Road Not Mapped:** the road is unknown, e.g. for newly built roads.
- **No Route:** no route could be calculated to the selected destination.
- **Off Map:** the map for the current location is not available.
- **Area of Destination Reached:** you have reached the area of destination.
- : you have reached the destination or an intermediate destination.

▶ **To exit the menu:** press the back button on the left.

In the **Navigation** menu, you can also start navigation to one of the previous destinations:

▶ Press the left-hand Touch Control.

▶ **To select a destination:** swipe upwards or downwards on the left-hand Touch Control.

▶ Press the left-hand Touch Control. Route guidance will start.

If route guidance has already been activated, a request will appear asking whether you wish to end the current route guidance.

- ▶ Select **Yes**.
- ▶ Press the left-hand Touch Control.
Route guidance will start.

Selecting radio stations using the on-board computer

On-board computer:

↳ Radio

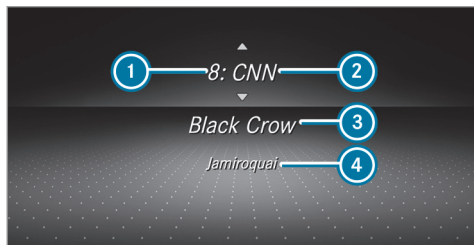

- ① Memory preset
- ② Channel name
- ③ Name of track
- ④ Name of artist

When you select a station from the memory presets, the preset will appear next to the station name. When you select a saved station in the frequency range, an asterisk will appear next to the station name.

- ▶ **To select a radio station:** swipe upwards or downwards on the left-hand Touch Control.

Selecting the frequency range or memory preset

- ▶ Press the left-hand Touch Control.
- ▶ **To select the frequency range/station preset:** swipe upwards or downwards on the left-hand Touch Control.
- ▶ Press the left-hand Touch Control.

Operating media playback using the on-board computer

On-board computer:

↳ Media



- ① Media source
- ② Track number and current track
- ③ Name of artist
- ④ Name of album

- ▶ **To change tracks on an active media source:** swipe upwards or downwards on the left-hand Touch Control.

Changing a media source

- ▶ Press the left-hand Touch Control.
- ▶ **To select a media source:** swipe upwards or downwards on the left-hand Touch Control.
- ▶ Press the left-hand Touch Control.

Dialing telephone numbers using the on-board computer

⚠ WARNING Risk of distraction from information systems and communications equipment

If you operate information and communication equipment integrated in the vehicle when driving, you will be distracted from the traffic situation. This could also cause you to lose control of the vehicle.

- ▶ Only operate this equipment when the traffic situation permits.
- ▶ If you cannot be sure of this, stop the vehicle whilst paying attention to road

and traffic conditions and operate the equipment with the vehicle stationary.

When using the phone, you must observe the legal requirements for the country in which you are currently driving.

Requirements:

- The mobile phone is connected to the multimedia system.

On-board computer:

↳ Phone

The most recent telephone calls (dialed, received and missed calls) are displayed on the Phone menu.

- ▶ **To select an entry:** swipe upwards or downwards on the left-hand Touch Control.
- ▶ Press the left-hand Touch Control.
If there is only one telephone number saved to an entry: the telephone number is selected.
- ▶ **If there are multiple telephone numbers saved to an entry:** swipe upwards or down-



wards on the left-hand touch control to select the desired telephone number.

- ▶ Press the left-hand Touch Control.
The telephone number will be dialed.



The following displays may appear instead of the telephone numbers dialed:

- **Please Wait...:** the application is starting. If a Bluetooth® connection to the mobile phone is not established, the menu for authorizing and connecting a mobile phone will be displayed on the multimedia system (→ page 248).
- **Updating data...:** the call list is being updated.
- **Importing Contacts...:** contacts are being imported from the mobile phone or a storage medium.

Accepting/rejecting an incoming call

- ▶ Swipe upwards or downwards on the left-hand Touch Control and select  (Accept) or  (Reject).
- ▶ Press the left-hand Touch Control.

182 Instrument Display and on-board computer

You may accept/reject the call using the 
or  button on the steering wheel.

Notes on operating safety

▲ WARNING Risk of distraction from information systems and communications equipment

If you operate information and communication equipment integrated in the vehicle when driving, you will be distracted from the traffic situation. This could also cause you to lose control of the vehicle.

- ▶ Only operate this equipment when the traffic situation permits.
- ▶ If you cannot be sure of this, stop the vehicle whilst paying attention to road and traffic conditions and operate the equipment with the vehicle stationary.

▲ WARNING Risk of an accident from operating mobile communication equipment while the vehicle is in motion

Mobile communications devices distract the driver from the traffic situation. This could

also cause the driver to lose control of the vehicle.

- ▶ As the driver, only operate mobile communications devices when the vehicle is stationary.
- ▶ As a vehicle occupant, only use mobile communications devices in the areas intended for this purpose, e.g. in the rear passenger compartment.

▲ WARNING Risk of injury due to objects being stowed incorrectly

If objects in the vehicle interior are stowed incorrectly, they can slide or be thrown around and hit vehicle occupants. In addition, cup holders, open stowage spaces and mobile phone receptacles cannot always retain all objects they contain.

There is a risk of injury, particularly in the event of sudden braking or a sudden change in direction.

- ▶ Always stow objects so that they cannot be thrown around in such situations.
- ▶ Always make sure that objects do not protrude from stowage spaces, luggage nets or stowage nets.
- ▶ Close the lockable stowage spaces before starting a journey.
- ▶ Always stow and secure heavy, hard, pointed, sharp-edged, fragile or bulky objects in the trunk/load compartment.

For your own safety, always observe the following points when operating mobile communications equipment and especially your voice control system:

- Observe the legal requirements for the country in which you are driving.
- While driving, only operate mobile communications equipment and your voice control system when the traffic conditions permit it. You may otherwise be distracted from the traffic conditions and cause an accident, injuring yourself and others.



- If you use the voice control system in an emergency your voice can change and your telephone call, e.g. an emergency call, can thereby be unnecessarily delayed.
- Familiarize yourself with the voice control system functions before starting the journey.
- Comply with the loading guidelines (→ page 88).

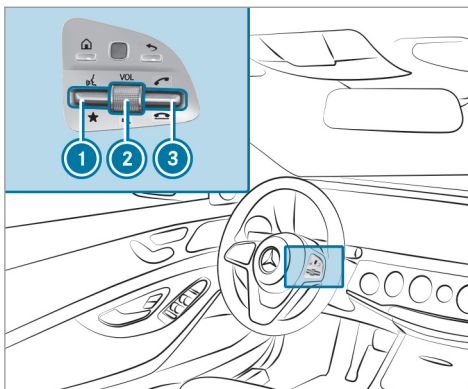

Operation

Overview of operation of the Voice Control System on the multifunction steering wheel

The Voice Control System is operational approximately thirty seconds after the ignition is switched on.



- 1 Press the rocker switch up:  starts the Voice Control System
- 2 Press the control knob:  switches the sound off or on (ends the Voice Control System)
Turn the control knob up/down: increases/decreases the volume

- 3 Press the rocker switch up:  makes/accepts a call
Press the rocker switch down:  rejects/ends a call (ends the Voice Control System)

Conducting a dialog with the Voice Control System

- ▶ **To start or continue a dialog:** on the multifunction steering wheel, press the  rocker switch up. You can say a voice command after an acoustic signal.
- ▶ **To correct an entry:** say the Correction voice command.
- ▶ **To select an entry from the selection list:** say the line number or the contents.
- ▶ **To browse the selection list:** say the Next or Back voice command.
- ▶ **To interrupt the dialog:** say the Pause voice command.
- ▶ **To cancel the dialog:** say the Cancel voice command.

Operable functions

You can use the Voice Control System to operate the following equipment depending on the features:

- Telephone
- Text messages
- Navigation
- Address book
- Radio
- Audio (memory card, Media Interface, USB and Bluetooth® audio)
- Vehicle

Overview of types of voice command

A distinction is made between the following voice commands:

- **Global voice commands** can be said at any time and regardless of the current application, e.g. the voice commands Navigate to, Call or Text message to.

- **Application-specific voice commands** are only available for the active application.

Once the Voice Control System is started an autocue is shown. Apart from the available voice commands for the application currently active, this also cites example voice commands for other applications which are not active. In this way, you will be familiar more quickly with the available voice commands. The list can be scrolled or it can be operated by speech or the controller/touchpad.

Notes on the language setting

You can change the language of the Voice Control System via the system language settings. If the set system language is not supported by the Voice Control System, English will be selected.

The Voice Control System is available in English, French, Portuguese and Spanish.

Using the Voice Control System effectively

Features of audible help functions

You receive information and help for the following topics:

- **Optimum operation:** say the brief instruction voice command.
- **Current application:** on the multifunction steering wheel, press the  rocker switch up and say the Help voice command.
- **Continued dialog:** say the Help voice command during a voice dialog.
- **Specific function:** say voice commands for the desired function, e.g. Help telephone.

Notes on how to improve speech quality

If the Voice Control System does not understand you:

- only operate the Voice Control System from the driver's seat.
- say the voice commands coherently and clearly, but do not exaggerate the words.

- avoid loud noises that cause interference while making a voice command entry, e.g. the blower.

A voice tag in the address book is not recognized:

- only create sensible address book entries in the system/mobile phone, e.g. enter surname and first name in the correct field.

- do not use any abbreviations, unnecessary spaces or special characters.

If a station list entry is not recognized:

- say the Read out station list voice command.

Essential voice commands

Overview of switch voice commands

Switch voice commands can be used to open certain applications. The voice command selection can be used regardless of the application that is currently active.

Switch voice commands

Voice command	Function
Navigation	To switch to navigation mode
Map	To switch to map display
Address book	To switch to address book
Telephone	To switch to telephone mode
Text message	To switch to text messages
Radio	To switch to radio mode
Media	To switch to media mode

Voice command	Function
USB	To switch to USB
Memory card	To switch to memory card
Internet application <Name>	To start a Mercedes-Benz online application. The application must be called up by touch once prior to use.
Mercedes-Benz Apps	To switch to Mercedes-Benz Apps
Connect	To switch to Internet mode
Vehicle menu	To switch to vehicle settings
System settings menu	To switch to system settings

Overview of navigation voice commands

Using navigation voice commands, you can enter POIs or conventional addresses as well as directly change important navigation settings.

Navigation voice commands

Voice command	Function
Navigate to <Address/POI/Contact>	Universal search for all types of destinations. A search is conducted in the address book contacts, the navigation database and on the Internet (POIs). The order of the details, e.g. city, street or house number, can be changed.
Address in <Country>	Destination entry in a desired country, e.g. address in France
Home	Starts navigation to home address
Work	Starts navigation to your workspace
POI <POI>	Destination entry for a POI, e.g. the POI Brandenburg Gate. A search is performed in the navigation database and on the Internet.
POI online search <POI>	Conducts a POI search on the Internet only
Navigate to contact <Name>	Destination entry to a contact in the address book

Voice command	Function
Enter country Enter city Enter district Enter street Enter intersection Enter house number Enter ZIP code	Enters a country/city/district/street/intersection/house number/ZIP code
Nearest restaurant Nearest parking lot Nearest rest area with restrooms Nearest gas station	Searches for nearby restaurants, parking lots, rest areas with restrooms and gas stations
Restaurant along the route Parking along the route Rest area with restrooms along the route Gas stations along the route	Searches for restaurants, parking options, rest areas with restrooms and gas stations along the route

Voice command	Function
Restaurant at destination Parking at destination Rest area with restrooms at destination Gas station at destination	Searches for restaurants, parking options, rest areas with restrooms and gas stations at the destination
Last destinations	Selects a destination from the list of last entered destinations
Alternative routes	Switches route guidance to another route
Start route guidance	Starts route guidance after entering a valid destination
Cancel route guidance	Cancels route guidance
Guidance instructions on Guidance instructions off	Switches the route guidance voice output on/off
Show traffic map Hide traffic map	Switches the traffic map on/off
Switch on POI symbols Switch off POI symbols	Switches the POI symbols display on the map on/off

Overview of telephone voice commands

You can use the telephone voice commands to make phone calls or search through the address book.

Telephone voice commands

Voice command	Function
Call <Name>	Makes a phone call. All address book names are available.
Search for contact <Name>	Searches for and displays a contact. All address book names are available.
Outgoing calls	Displays the last call
Redial	Selects the last phone number dialed

Overview of radio voice commands

Radio voice commands can also be used when the radio application is running in the background.

Radio voice commands

Voice command	Function
Station <Name>	To call up receivable or saved stations
<Frequency>	To enter a frequency directly
Next station	To switch to the next available station
Previous station	To switch to the previous station
Save station	To save a station in the station list
Show station list	To display the names of all receivable stations
Read out station list	To listen to the names of all receivable stations
Traffic information on Traffic information off	To switch the traffic information service on/off
Radio info on Radio info off	To switch information about the current station on/off

Overview of media player voice commands

Media player voice commands can also be used when the media player is running in the background.

Media player voice commands

Voice command	Function
Play <Tracks> Play <Albums> Play <Artists> Play<Composers> Play <Genres> Play <Playlists>	The names of all available tracks, albums, artists, composers, genres or playlists are accepted during the search.
Media search <Track> Media search <Albums> Media search <Artists> Media search <Composers> Media search <Genres> Media search <Playlists>	The names of all available tracks, albums, artists, composers, genres or playlists are accepted during the search.

Voice command	Function
Show all albums Show all artists Show all composers Show all genres Show all tracks Show all playlists	Available albums, artists, composers, genres, tracks or playlists are searched for.
Next track	To select the next track
Previous track	To select the previous track
Random track list on Random track list off	To switch the random track list on/off

Overview of message voice commands

Text messages can be created, edited and listened to using the message voice commands.

Message voice commands

Voice command	Function
Text message to <Name>	To create a message. All address book names are available.
Reply	To reply to a message
Forward text message	To forward a message

Overview of vehicle voice commands

You can use the vehicle voice commands to directly call up the corresponding menus for the vehicle settings.

Vehicle voice commands

Voice command	Function
Display and styles menu	To show display settings
Assistance menu	To display assistance settings
Climate control menu	To display climate control settings
Light menu	To display light settings

Voice command	Function
Outside temperature	To display the outside temperature
Engine data	To display engine data
Consumption menu	To display consumption
Vehicle data	To display vehicle data

Overview and operation

Overview of the multimedia system

⚠ WARNING Risk of distraction from information systems and communications equipment

If you operate information and communication equipment integrated in the vehicle when driving, you will be distracted from the traffic situation. This could also cause you to lose control of the vehicle.

- ▶ Only operate this equipment when the traffic situation permits.
- ▶ If you cannot be sure of this, stop the vehicle whilst paying attention to road and traffic conditions and operate the equipment with the vehicle stationary.

You must observe the legal requirements for the country in which you are currently driving when operating the multimedia system.

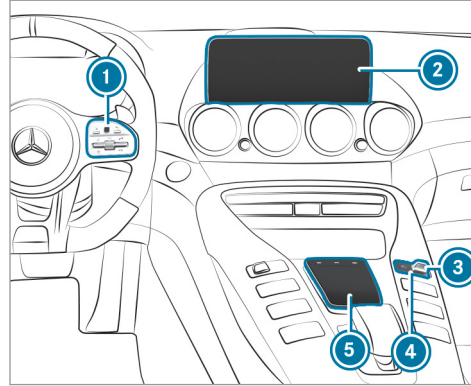

Equipment with touchpad

- ① Touch Control
Multimedia system button group on the steering wheel (→ page 170)
- ② Media display
- ③ Press the rocker switch up or down: increases or decreases the volume (→ page 203)
- ④ Display button shows volume, current volume when setting the volume or mute

Press the display button: switches the multimedia system on/off

- ⑤ Touchpad

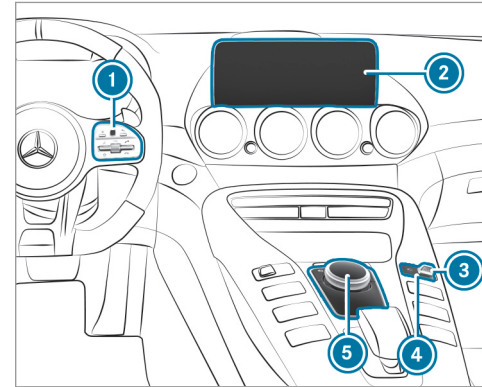

Equipment with controller

- ① Touch Control
Multimedia system button group on the steering wheel (→ page 170)
- ② Media display

- ③ Press the rocker switch up or down: increases or decreases the volume (→ page 203)
- ④ Display button shows volume, current volume when setting the volume or mute
Press the display button: switches the multimedia system on/off
- ⑤ Touchpad or controller

Notes on the media display

1 NOTE Scratches on the display

The display has a highly sensitive, high-gloss surface. There is a risk of it becoming scratched.

- ▶ Avoid touching the display.
- ▶ Observe the notes on cleaning.

Observe the notes on caring for the interior (→ page 310).

Automatic temperature-controlled switch-off feature: if the temperature is too high, the brightness is initially reduced automatically. The

display may then switch off completely for a while.

- ① If you are wearing polarized sunglasses, it may be difficult to read the display.

Central control elements overview

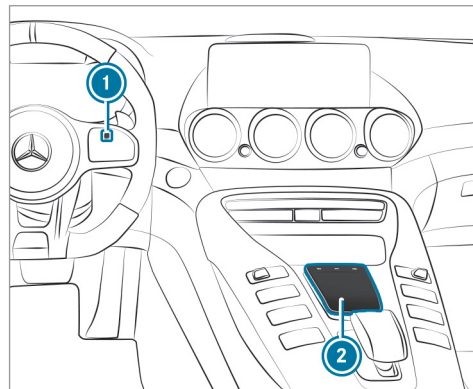

Touchpad equipment

- ① Touch Control
- ② Touchpad

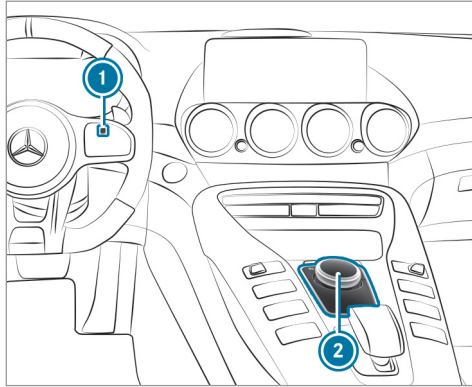

Controller equipment

- ① Touch Control
- ② Controller

Touch Control

Operating Touch Control

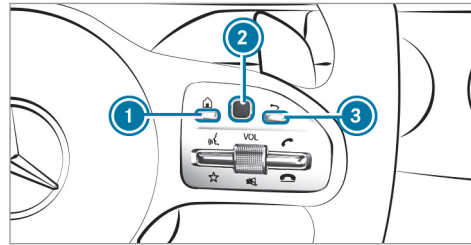

- ▶ **To call up main functions:** press button ①.

or

- ▶ Press and hold button ③.
- ▶ **To call up favorites:** press button ①.
- ▶ Swipe down on Touch Control ②.
- ▶ **To open a list:** press Touch Control ②.
- ▶ **To close a list:** press button ③.

or

- ▶ Swipe right on Touch Control ②.

- ▶ **To select a menu item:** swipe up, down, left or right on Touch Control ②.
- ▶ Press Touch Control ②.
- ▶ **To move the digital map:** swipe in any direction.

Setting the sensitivity for the Touch Control

Multimedia system:



- ▶ System ▶ Input
- ▶ Touch Control Sensitivity
- ▶ Select Fast, Medium or Slow.

Operating the controller



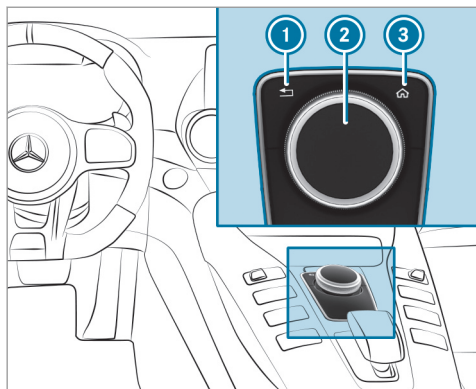

Requirements:

- The multimedia system is equipped with a controller.



- 1  button
Press briefly: returns to the previous display
Press and hold: calls up main functions
- 2 Controller
- 3  button
Calls up main functions and favorites

Controller operating options:

- ▶ Turn  counter-clockwise or clockwise.
- ▶ Slide  left or right.
- ▶ Slide  up or down.
- ▶ Slide  diagonally.
- ▶ Press  briefly or press and hold.



Touchpad

Operating the touchpad

Requirements:

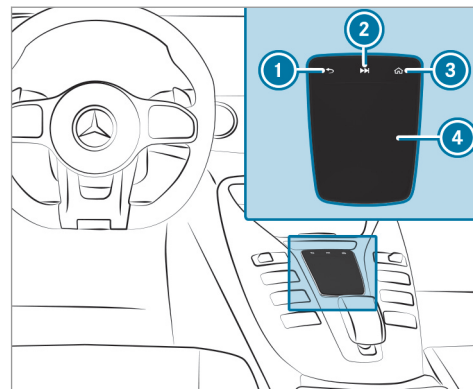
- The multimedia system is equipped with a touchpad.



- 1  button
Pressing briefly: returns to the previous display
- 2  button
Calls up the control menu of the last active audio source
- 3  button

Calls up main functions and favorites

④ Touchpad

You can navigate in menus and lists via touch-sensitive surface ④ by using a **single-finger swipe**.

- ▶ **To open or close lists:** swipe left or right.
- ▶ **To select the menu item:** swipe up, down, left or right.
- ▶ Press touchpad ④.
- ▶ **To move the digital map:** swipe in any direction.

Use the following functions with a two-finger swipe:

- ▶ **To call up main functions and favorites:** swipe down with two fingers. The swipe must start in the upper area of the touchpad.
- ▶ **To zoom in and out of the map:** move two fingers together or apart.
- ▶ **To call up the control menu of the last active audio source:** swipe up with two fingers. The swipe must start in the lower area of the touchpad.

Setting the sensitivity for the touchpad

Multimedia system:

↳ System ▶  Input

- ▶ Select **Touchpad Sensitivity**.
- ▶ Select **Fast**, **Medium** or **Slow**.
- ▶ **To set the pressure sensitivity:** switch **Touchpad Tap** on or off . If the function is switched on , a tap on the touchpad is enough to select a menu item.

Handwriting recognition: switching the read-aloud function on/off

Multimedia system:

↳ System ▶  Audio

▶▶ System Feedback

- ▶ Switch **Read Out Handwriting Recognition** on or off .

Activating/deactivating haptic operating feedback on the touchpad

Multimedia system:

↳ System ▶  Input

The function supports you when making entries on the touchpad and when selecting menus.

- ▶ Switch **Haptic Operating Feedback** on or off . When the function is activated, a tactile feedback in the form of a vibration is effected when the touchpad is operated.

Selecting a station and track using the touchpad

- ▶ Press the  button on the touchpad.

or

- ▶ Swipe up with two fingers. The swipe must start in the lower area of the touchpad. The control menu appears for the audio source that was last selected.
- ▶ Use one finger to swipe up or down. Radio: the previous or the next station is set. Media source: the previous or the next music track is selected.

- ▶ **To hide the control menu:** swipe down with two fingers. The swipe must start in the upper area of the touchpad.

Favorites

Overview of favorites

Favorites offer you quick access to frequently used applications. It is possible to create 20 favorites in total.

The following functions are available:

- add **pre-defined favorites** from the following categories (→ page 202):
 - [Navigation](#)
 - [Entertainment](#)
 - [Phone](#)
 - [Connect](#)
 - [Vehicle](#)
 - [System Settings](#)
- add **your own favorites** (→ page 202)
- rename favorites (→ page 202).
- move favorites (→ page 203).

- delete favorites (→ page 203).
- reset all favorites (→ page 203)

Calling up favorites

- ▶ Press the  button. The main functions are displayed.
- ▶ Navigate downwards once. Navigating means:
 - Swiping on the Touch Control or the touchpad

Leaving the favorites menu

- ▶ Press the  button.

Adding favorites

Adding predefined favorites

- ▶ Press the  button. The main functions are displayed.
- ▶ Navigate downwards twice. The Favorites menu appears.
- ▶ Select [New Favorite](#). The categories are displayed.

- ▶ Select a category. The favorites are displayed.
- ▶ Select a favorite.
- ▶ Store the favorite at the desired position. If a favorite has already been added at this position, it will be overwritten.

Example: adding your own favorites

- ▶ Select [Vehicle](#).
- ▶ Select [Full Screen: Consumption](#).
- ▶ Press and hold the  button until the favorites are displayed.
- ▶ Store the favorite at the desired position.

If [No function available for saving](#). is shown, the selected function cannot be added.

Renaming favorites

- ▶ Press the  button. The main functions are displayed.
- ▶ Navigate downwards once.
- ▶ Select a favorite.
- ▶ Navigate downwards once. The Favorites menu appears.

- ▶ Select **Rename**.
- ▶ Enter the characters.
- ▶ **To confirm the entry:** select **OK**.

Moving favorites

- ▶ Press the  button.
The main functions are displayed.
- ▶ Navigate downwards once.
- ▶ Select a favorite.
- ▶ Navigate downwards once.
The Favorites menu appears.
- ▶ Select **Move**.
- ▶ Move the favorite to the desired position.
If a favorite has already been added at this position, it will be overwritten.



Deleting favorites

- ▶ Press the  button.
The main functions are displayed.
- ▶ Navigate downwards once.
- ▶ Select a favorite.
- ▶ Navigate downwards once.
The Favorites menu appears.

- ▶ **To delete:** select **Delete**.
- ▶ Select **Yes**.
- ▶ **To restore all favorites:** select **Reset All**.
A prompt appears.
- ▶ Select **Yes**.
The favorites are reset to the factory settings.

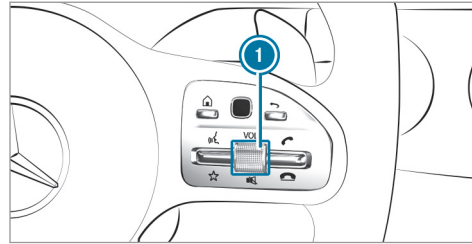
Switching the sound on/off



- ▶ **To mute:** press volume control .
The  symbol appears in the status line of the media display.

You will also hear traffic announcements and navigation announcements even when the sound is muted.

- ▶ **To switch on:** change the media source or turn volume control .

Adjusting the volume

Setting with the volume control on the multi-function steering wheel

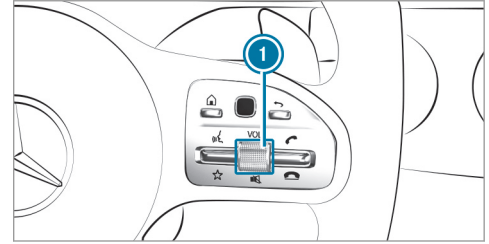

- ▶ Turn volume control .
The volume of the current radio or media source is set. The volume of other audio sources can be adjusted separately.

Adjust this in the following situations:

- during a traffic announcement
- during a navigation announcement

The volume of the navigation announcement changes in accordance with the volume of the current media source.

- during a telephone call
- when entering or exiting a parking space while using Active Parking Assist

Setting with the rocker switch on the multimedia system

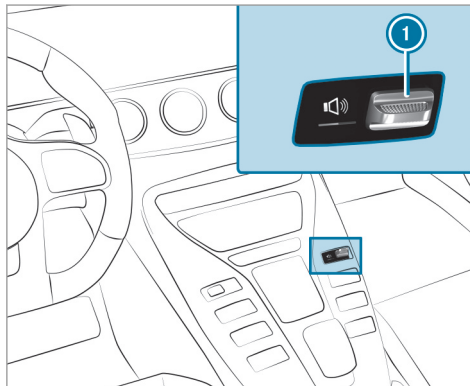

- ▶ Press rocker switch ① up or down. The volume is increased or reduced.

When adjusting the volume, the display button to the left of the rocker switch shows the current volume.

Setting in the menu

- ▶ Select **System** in the multimedia system.
- ▶ Select **Audio**.
- ▶ Select a volume setting.
- ▶ Set the volume.

Entering characters

Using the character input function

⚠ WARNING Risk of distraction from information systems and communications equipment

If you operate information and communication equipment integrated in the vehicle when driving, you will be distracted from the traffic situation. This could also cause you to lose control of the vehicle.

- ▶ Only operate this equipment when the traffic situation permits.
- ▶ If you cannot be sure of this, stop the vehicle whilst paying attention to road

and traffic conditions and operate the equipment with the vehicle stationary.

You must observe the legal requirements for the country in which you are currently driving when operating the multimedia system.

Use the character input function in the following situations, for example:

- Renaming a favorite
- Entering a POI or address
- Making a phone call

The following functions are available:

- Selecting a character in the character bar
- Writing a character on the touchpad

Character input can be started with a control element and resumed with another.

The multimedia system is equipped with either a touchpad or controller.

▶ **On the Touch Control and controller (if available):** select the characters in the character bar.

Depending on the target entry, the following characters are available:

- The full set of characters is shown
 - Only those characters which are useful for the current input string are shown
- Other characters are grayed out.

▶ **On the touchpad (if available):** select the characters in the character bar.

or

▶ Write the characters on the touch-sensitive surface of the touchpad. Handwriting recognition supports you by means of character suggestions and a read-aloud function.

Examples of character entry:

- Renaming a favorite
- Entering a POI or an address using free or step-by-step search
- Entering a web address

Entering characters on the touchpad
Requirements:

- The entered or selected character should be read out: the handwriting recognition read-aloud function is switched on (→ page 201).

Example: renaming favorites

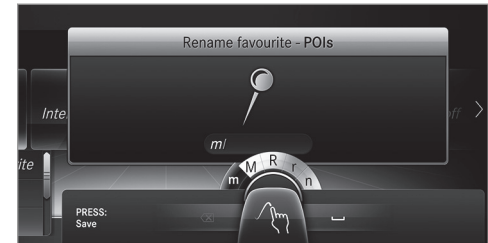

▶ Call up the "Renaming favorites" function (→ page 202).

▶ **To enter a character:** use your finger to write characters on the touchpad. The character is entered in the input line. If different interpretations are possible, character suggestions are displayed.

- ▶ **To select a character suggestion:** swipe up or down on the touchpad.
 - ▶ Resume character input.
 - ▶ **To enter a space:** swipe right when the cursor is located in the input line.
 - ▶ **To delete a character:** swipe left when the cursor is located in the input line.
 - ▶ **To confirm the entry:** press the touchpad.
 - ▶ **To finish character entry:** swipe upwards.
- or
- ▶ Press the  button.

Example: entering a destination (navigation)

- ▶ Enter the POI or address (→ page 222).

System settings

Display

Configuring display settings

Multimedia system:

- ↳ System ▶  Display and Designs

Setting the display brightness

- ▶ Select [Display Brightness](#).
- ▶ Select a brightness value.

Switching the display off/on

- ▶ **Off:** select [Display Off](#).
- ▶ **On:** press a button, , for example.

Display design

- ▶ Select [Day/Night Design](#).
- ▶ Select [Automatic](#), [Day Design](#) or [Night Design](#).

Additional display area

Depending on the vehicle, various items of additional information can be shown. The additional display area comprises the left-hand or right-hand third of the display.

- ▶ Select [Additional Disp. Area](#).

The following display content can be selected:

- [Dynamic](#)
- [Navigation Map](#)
- [Consumption](#)
- [Time and Date](#)

Time and date

Setting the time and date automatically

Multimedia system:

- ↳ System ▶  Time and Date

- ▶ Deactivate [Manual Time Adjustment](#).
The time and date are set automatically for the selected time zone and summer time option.

i The correct time is required for the following functions:

- Route guidance with time-dependent traffic guidance.
- Calculation of expected time of arrival.

Setting the time zone

Multimedia system:

↳ System >>  Time and Date

>> Time Zone:

The list of countries is displayed.

- ▶ Select a country •.
Depending on the country, time zones are displayed.
- ▶ Select a time zone.
The time zone set is displayed after [Time Zone](#).

Setting summer time

The [Automatic Daylight Saving Time](#) and [Daylight Saving Time](#) options cannot be selected in all countries.

Multimedia system:

↳ System >>  Time and Date

Automatically

- ▶ Switch [Automatic Daylight Saving Time](#) on or off .

Manually

- ▶ Deactivate [Automatic Daylight Saving Time](#).
- ▶ Select [Daylight Saving Time](#).
- ▶ Select [On](#) or [Off](#).

Setting the time and date format

Multimedia system:

↳ System >>  Time and Date

>> Set Format

- ▶ Set the date and time format •.

Setting the time manually

Requirements:

- The [Manual Time Adjustment](#) function is switched on.

Multimedia system:

↳ System >>  Time and Date

>> Set Time

- ▶ Set the hours.
- ▶ Navigate to the right to set the minutes.
- ▶ Set the minutes.

- ▶ Confirm changes when exiting the menu.

The date is set automatically via GPS.

Bluetooth®

Information about Bluetooth®

Bluetooth® technology is a standard for short-range wireless data transfer up to approximately 32.8 ft (10 m).

You can use Bluetooth® to connect your mobile phone to the multimedia system and use the following functions, for example:

- Hands-free system with access to the following options:
 - contacts (→ page 252)
 - call lists (→ page 254)
 - text message (→ page 255)
- Internet connection (→ page 267)
- Listening to music via Bluetooth® audio
- Transferring business cards (vCards) into the vehicle

Bluetooth® is a registered trademark of Bluetooth Special Interest Group (SIG) Inc.

 Internet connection via Bluetooth® is not available in all countries.

Activating/deactivating Bluetooth® Requirements:

- Deactivate Bluetooth®: Apple CarPlay™ is not active.

Multimedia system:

 System  Connectivity

 Activate or deactivate Bluetooth®.

If Android Auto is active, a prompt appears asking whether Bluetooth® should be deactivated.

 Select **Yes**.

Android Auto is closed and Bluetooth® is deactivated.

Wi-Fi

Wi-Fi connection overview

You can use Wi-Fi to establish a connection with a Wi-Fi network and to access the Internet or other network devices.

The following connection options are available:

- Wi-Fi connection

The Wi-Fi connection to a Wi-Fi-capable device, e.g. the customer's mobile phone or a tablet PC is established.

- Multimedia system as a Wi-Fi hotspot

Using this function, a tablet PC or notebook can be connected, for example.

To establish a connection, you can use the following methods:

- WPS PIN

The connection to a secure Wi-Fi network is made via a PIN.

- WPS PBC

The connection to a secure Wi-Fi network is made by pressing a button (push button).

- Security key

The connection to a secure Wi-Fi network is made via a security key.

Setting up Wi-Fi Requirements:

- The device to be connected supports one of the three means of connection described (→ page 208).

Multimedia system:

 System  Connectivity

Activating/deactivating Wi-Fi

 Switch **Wi-Fi** on or off .

If **Wi-Fi** is deactivated , communication via Wi-Fi to all devices is interrupted. This also means that a connection to the HERMES communication module cannot be established. Then functions such as dynamic route guidance with Live Traffic Information are not available.

Connecting the multimedia system with a device via Wi-Fi

This function is available if a HERMES communication module is not installed.

The type of connection established must be selected on the multimedia system and on the device to be connected.

 The connection procedure may differ depending on the device. Follow the instructions that are shown in the display. Further information (see the manufacturer's operating instructions).

- ▶ Select [Internet Settings](#).
- ▶ Select [Search for Wi-Fi Networks](#).

Using a security key



- ▶ Select a Wi-Fi network in the list.
- ▶ Have the security key displayed on the device to be connected (see the manufacturer's operating instructions).
- ▶ Enter this security key on the multimedia system.
- ▶ Confirm the entry with .

 All devices support a security key as a means of connection.

Using a WPS PIN

- ▶ Highlight a Wi-Fi network in the list.
- ▶ Select  [Connect via WPS PIN Input](#). The multimedia system generates an eight-digit PIN.
- ▶ Enter this PIN on the device to be connected.
- ▶ Confirm the entry.

Using a button

-  This function is only available in a Wi-Fi frequency of 2.4 GHz.
- ▶ Highlight a Wi-Fi network in the list.
- ▶ Select  [Connect via WPS PBC](#).
- ▶ Select "Connect via WPS PBC" in the options on the device to be connected.
- ▶ Press the WPS button on the device to be connected.
- ▶ Select [Continue](#) in the multimedia system.

Device has already been connected:

- ▶ **To automatically connect:** highlight a Wi-Fi network in the list.

- ▶ Activate  [Connect Automatically](#) .

▶ **To connect:** highlight a Wi-Fi network in the list.

- ▶ Select  [Connect](#). The connection is established again. These functions are possible when the device has already been connected to the Wi-Fi network.

Setting up a Wi-Fi hotspot Requirements:

- **For connection by pressing a button:** this function is only available in a Wi-Fi frequency of 2.4 GHz.

Multimedia system:

 [System](#) ▶  [Connectivity](#)

Configuring the multimedia system as a Wi-Fi hotspot

The type of connection established depends on the device to be connected. The function must be supported by the multimedia system and by the device to be connected. The type of connection established must be selected on the multimedia system and on the device to be connected.

- ▶ Select [Set Up Hotspot](#).
- ▶ Highlight [Connect Device to Vehicle Hotspot](#).

Generating a WPS PIN

- ▶ Select  [Connect via WPS PIN Generation](#).
- ▶ Enter the PIN shown in the media display on the device to be connected and confirm.

Connecting using a WPS PIN

- ▶ Select  [Connect via WPS PIN Input](#).
- ▶ Select [Enter WPS PIN](#).
- ▶ Enter the PIN that is shown on the external device's display on the multimedia system.
- ▶ Select [Continue](#).

Connecting using a button

- ▶ Select  [Connect via WPS PBC](#).
- ▶ Press the WPS button on the device to be connected or select [Connect](#).
- ▶ Select [Continue](#) in the multimedia system.

Connecting using a security key

- ▶ Select [Connect Device to Vehicle Hotspot](#). A security key is displayed.
- ▶ Select the vehicle from the device to be connected. The vehicle is displayed with the SSID [MB Hotspot XXXXX](#).
- ▶ Enter the security key which is shown in the media display on the device to be connected.
- ▶ Confirm the entry.

Generating a new security key:

- ▶ Select [Set Up Hotspot](#).
- ▶ Select [Generate Security Key](#). A connection will be established with the newly created security key.
- ▶ **To save a security key:** select [Save](#). When a new security key is saved, all existing Wi-Fi connections are then disconnected. If the Wi-Fi connections are being re-established, the new security key must be entered.

Managing COMAND Touch devices

Requirements:

- The COMAND Touch app is installed on the external device (e.g. tablet or smartphone).
- Wi-Fi is activated (→ page 208) and the multimedia system is configured as a Wi-Fi hotspot (→ page 209).

Multimedia system:

↳ [System](#) ▶ [COMAND Touch](#)

Connecting and authorizing a new device

- ▶ Select [Authorize a New Device](#).
- ▶ Select [Connect New Device](#).
- ▶ Enter the security key in the external device. The [Please start COMAND Touch on your device and follow the instructions](#). message appears.
- ▶ Select [Continue](#).
- ▶ [Accept](#) the connection request from the new device.
- ▶ Enter the PIN shown on the external device. The device is authorized.

Authorizing a connected device

- ▶ Select [Authorize a New Device](#).
The devices already connected are displayed.
- ▶ Select [Continue Using Connected Devices](#).
The [Please start COMAND Touch on your device and follow the instructions](#). message appears.
- ▶ Select [Continue](#).
- ▶ The connection request from the device [Accept](#).
- ▶ Enter the PIN shown on the external device.
The device is authorized.

De-authorizing the device

- ▶ Select an authorized device from the list.
A prompt will appear asking whether you would like to de-authorize the selected device.
- ▶ Select [Yes](#).
The device is de-authorized.

Activating/deactivating child safety lock

Multimedia system:

↳ System ▶ Parental Control

Locking an external device

- ▶ Select an external device.
- ▶ Select [Lock](#).
The device connected via the COMAND Touch app is locked or unlocked .

System language

Notes on the system language

This function allows you to determine the language for the menu displays and the navigation announcements. The selected language affects the characters available for entry. The navigation announcements are not available in all languages. If a language is not available, the navigation announcements will be in English.

Setting the system language

Multimedia system:

↳ System ▶ Language

- ▶ Set the language.

Setting the distance unit

Multimedia system:

↳ System ▶  Units

- ▶ Select [km](#) or [mi](#).
- ▶ In the multifunction display of the Instrument Display, switch the [Additional Speedometer](#) display on .

Data import and export

Data import/export function

The following functions are possible:

- Transferring data from one system or vehicle to another system or vehicle.
- Creating a backup copy of your personal data and loading it again.

- Protecting your personal data against unwanted export with PIN protection.
- ❗ Please note that the NTFS file system is not supported. The FAT32 file system is recommended.

Importing/exporting data

! **NOTE** Loss of data due to premature removal

- ▶ Do not remove the data storage medium when data is being exported.

Mercedes-Benz is not liable for any loss of data.

Requirements:

- The vehicle is stationary.
- The ignition is switched on or the vehicle has been started.
- The SD card is inserted (→ page 275) or the USB device is connected (→ page 276).

Multimedia system:

↳ System ▶▶ System Backup

- ▶ Select **Import Data** or **Export Data**.

Importing

- ▶ Select a data storage medium. A prompt appears asking whether you really wish to overwrite the current data. If data originates from another vehicle, this is recognized during data reading.

The multimedia system is restarted once the data has been imported.

- ❗ Current vehicle settings can be edited after the import.

Exporting

If PIN protection is activated, your PIN is requested.

- ▶ Enter the four-digit PIN.
- ▶ Select a data storage medium. The data is exported. The data export may take several minutes.

Activating/deactivating PIN protection

Requirements

To unlock the PIN:

- There is an Internet connection.
- A Mercedes me account exists at <http://www.mercedes.me>.
- The **Personalization** service is active (→ page 213).

Multimedia system:

↳ System ▶▶ PIN Protection

Setting the PIN

- ▶ Select **Set PIN**.
- ▶ Enter a four-digit PIN.
- ▶ Enter the four-digit PIN again. If both PINs match, PIN protection is active.

Changing the PIN

- ▶ Select **Change Settings**.
- ▶ Enter the current PIN.
- ▶ Select **Change PIN**.
- ▶ Set a new PIN.

Activating PIN protection for data export

- ▶ Select **Change Settings**.
Confirm with the PIN.
- ▶ Select **Protect Data Export**.
Activate or deactivate the function.

Unblocking the PIN

If the PIN has been entered incorrectly three times, the PIN will be blocked. You can have a single-use password sent to you via the Mercedes me connect online portal to reset the PIN protection.

- ▶ Select **Unblock PIN**.
- ▶ Enter the single-use password.
PIN protection is reset, and you can set a new PIN.
- ❗ Alternatively, you can have PIN protection reset at an authorized Mercedes-Benz Center.

User profile

Setting a user profile

Multimedia system:

↳ System ▶  Personalization

Displaying a user profile when starting

If this function is active, a prompt appears when starting the system asking which user profile to use.

- ▶ Select **Display Profile Selection after Start**.
- ▶ Activate or deactivate the function.

Selecting a user profile

- ▶ Select **Guest Profile** or individual profile ●.
- ❗ Some settings from the user profile are only loaded when the vehicle is stationary or when the ignition is switched on.

Automatic synchronization

Each time the ignition is switched off or on, the individual user profiles are synchronized on the multimedia system and on the server. This ensures that the latest user profiles are available.

- ▶ Select **Automatic Synchronization**.
- ▶ Activate or deactivate the function.
- ❗ For more information about importing/exporting user profiles (→ page 213).

Creating a user profile

Multimedia system:

↳ System ▶  Personalization
▶ Create Profile

- ▶ Enter a name.
- ▶ Select **OK**.

The following information is saved in the user profile, for example:

- System settings
- Settings in the TV tuner's channel list
- Navigation and traffic information

The settings differ depending on the vehicle equipment.

Importing/exporting user profiles Requirements:

- There is an Internet connection .

- A Mercedes me account exists at <http://www.mercedes.me>.
- The **Personalization** service is active.

Multimedia system:

→ System »  Personalization
 » Manual Export/Import

This function is not available in all countries.

Only individual profiles can be imported or exported.

The individual profiles are always collectively imported or exported.

- ▶ **Import:** select **Import Profiles from Server**. The **The profile data import overwrites all existing profile data. Do you want to continue?** message appears.
 - ▶ Select **Yes**. User profiles are imported.
 - ▶ **Export:** select **Export Profiles to the Server**. User profiles are exported.
-  Certain settings, such as address book entries or previous destinations from the navigation system, are not exported.

Setting user profile options

Multimedia system:

→ System »  Personalization

- ▶ Highlight a profile.
- ▶ Select  options.

The following options are available:

- **Rename**
 - **Delete**
 - **Reset**
-  The guest profile cannot be deleted or renamed.

Software update

Information on software updates

The multimedia system provides a message when an update is available.

Depending on the source, you can perform various updates:

Software update

Source of the update	Update type
Updates via mobile phone	Navigation map, system updates, Digital Operator's Manual
Updates via an external storage medium, e.g. a USB flash drive	Navigation maps

-  Updates via mobile phone require an active Internet connection for the vehicle. This is not available in all countries. For further information on connecting to the Internet, see (→ page 267).

Advantages of updating software

Software updates ensure your vehicle's technology is up-to-date.

In order to constantly improve the quality of our services you will receive future updates for your multimedia system, the Mercedes me connect services and your vehicle's communication module. These will conveniently be sent to you via

the mobile phone connection in your vehicle and, as an option, installed automatically. You can monitor the status of your updates on the Mercedes me portal and find information about potential innovations.

Your advantages at a glance:

- Conveniently receive software updates via the mobile phone network
- Improves the quality and availability of Mercedes me connect services
- Keeps your multimedia system and communication module up-to-date

Further information about software updates can be found at <http://me.mercedes-benz.com>

Performing a software update

Requirements:

- There is an Internet connection (→ page 267).
- **For automatic updates:** your vehicle has a permanently installed communication module.

Multimedia system:

→ System ▶▶ Software Update

Automatic update

- ▶ Switch **Automatic Online Update** on . Updates are performed.
The current status of the updates is displayed.

Manual update

- ▶ Deactivate **Automatic Online Update**.
- ▶ Select an update from the list and start the update.

Activating the software update

- ▶ Restart the system.

Function of important system updates

Important system updates may be necessary for the security of your multimedia system's data. Please install these updates, or else the security of your multimedia system cannot be ensured.

- ⓘ If automatic software updates are activated, the system updates will be downloaded automatically (→ page 215).

As soon as an update is available for download, a corresponding message appears on the media display.

You have the following selection options:

- **Download**
The update will be downloaded in the background.
- **Details**
Information about the pending system update is displayed.
- **Later**
The update can be downloaded manually at a later time (→ page 215).

If the download is completed and the update is ready for installation, you will be informed of this after the next ignition cycle, for example.

- ⓘ Park the vehicle safely in a suitable location before starting the installation.

Requirements for the installation:

- The ignition is switched on.
- The engine is not running.

- Notes and warnings have been read and accepted.
- The parking brake is applied.

If all requirements are met, the update will be installed. The multimedia system cannot be operated while the update is being installed and vehicle functions are restricted.

If errors should occur during the installation, the multimedia system automatically attempts to restore the previous version. If restoration of the previous version is not possible, a symbol appears on the multimedia system display. Please consult a qualified specialist workshop to resolve the problem.

Reset function

Multimedia system:

↳ System ▶▶ Reset

Personal data is deleted, for example:

- Station presets
- Connected mobile phones

▶ Select **Yes**.

If PIN protection is activated, a prompt appears asking if you also wish to restore this to the factory settings during a reset.

▶ Select **Yes**.

▶ Enter the current PIN.
The PIN is reset.

or

▶ Select **No**.

The current PIN stays the same after resetting.

ⓘ If you have forgotten your PIN, an authorized Mercedes-Benz Center can deactivate the PIN protection for you.

A prompt appears again asking whether you really wish to reset.

▶ Select **Yes**.

The multimedia system is reset to the factory settings.

AMG TRACK PACE

General information

With AMG TRACK PACE, the driving characteristics on race tracks can be analyzed and optimized. You can drive previously stored race tracks (e.g. Hockenheimring) or new tracks can be recorded and stored. The driven lap times are stored for every track. These can be analyzed and compared to other lap times to achieve the best possible race results. Additionally, acceleration and braking procedures can be measured and stored.

Please note: Use AMG TRACK PACE only on closed off routes outside the public traffic area. Adapt your driving style to your personal performance and environmental conditions. As the driver, you are solely responsible for driving your vehicle. Park your vehicle safely before operating the application.

Setting Track Race

Multimedia system:

↳ Vehicle ▶ TRACK PACE ▶ Track Race

Recording a track

- ▶ Select **New track**.
- ▶ At the desired starting point, select **Start**. The track recording starts at this point. During track recording, sectors can be set to determine intervals.
- ▶ To finish track recording, select **Stop** or cross the starting line again.
- ▶ Enter the weather and the track name.

Searching by track name

- ▶ Select **All tracks**.
- ▶ Select  **Search**.
- ▶ Enter the track name. Tracks with the searched name are displayed.

Measuring the time on the track

- ▶ Select **Timekeeping**. An overview of nearby tracks appears.

The distance and direction to the starting line of the track is displayed.

- ▶ Select the desired track. If you have already driven on this track, you can select a driven time as a reference time.

Timekeeping begins automatically when the starting line has been crossed.

- ⓘ When **Zoom** is selected, the track display can be switched from 2D to 3D.

Displaying the analysis

- ▶ Select **Lap times**. An overview of all the driven times appears.
- ▶ Select a track.

The following data is displayed:

- Lap and sector times
- Average and top speed
- Driver
- Vehicle
- Date
- Weather

- ▶ Select a desired lap. The analysis is displayed.

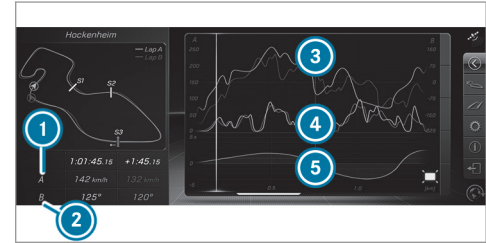

- ① Parameter 1 (e.g. speed)
 - ② Parameter 2 (e.g. steering angle)
 - ③ Speed trend (Parameter 1)
 - ④ Steering angle trend (Parameter 2)
 - ⑤ Time difference between lap A and B (only when two laps are selected).
- ⓘ The following values can be set for parameters 1 and 2, for example:
 - Speed
 - Longitudinal/lateral acceleration

- Steering angle
- Engine speed
- Engine oil/tire temperature

Based on the analysis you can check and optimize driving characteristics for any position on the track.

Exporting tracks or races (USB)

- ▶ Select **All tracks**.
An overview of all stored tracks and races appears.
- ▶ Highlight desired tracks or races.
- ▶ Select  Options.
- ▶ Select **Export**.
The selected tracks or races can be exported to a USB storage device connected to the vehicle.

Editing tracks and recordings

- ▶ Select **All tracks**.
- ▶ Highlight the desired track.
- ▶ Select  options.
- ▶ Select **Rename** or **Delete**.

or

- ▶ Select a track.
- ▶ Highlight the desired recording.
- ▶ Select  options.
- ▶ Select **Weather** or **Delete**.

Setting Drag Race

Multimedia system:

 **Vehicle** ▶ **TRACK PACE** ▶ **Drag Race**

Measuring acceleration

- ▶ Select **Acceleration**.
Measurement begins when the vehicle accelerates. Measurement is incremental, in steps of 30 mph (50 km/h) up to a maximum of 180 mph (300 km/h) or up to the set maximum speed.
Measurement can be stopped early by selecting **Stop** or by stopping the vehicle.

Quarter-mile race

- ▶ Select **Quarter Mile**.
The time measurement runs until a mile has been traveled or a previously set distance (e.g. 1/4 mile, 1/3 mile or 1/2 mile) has been reached.
- ⓘ The possible values for setting the end distance are determined by the system and cannot be freely chosen.

Measurement can be stopped early by selecting **Stop** or by stopping the vehicle.

Manual start for acceleration and quarter-mile race

- ▶ Select **Acceleration** or **Quarter Mile**.
- ▶ Select **Manual start**.
Three red traffic lights appear one after the other. The reaction time measurement starts when they change to green at the same time. The reaction time is displayed as soon as you drive off. If you drive off too early, the message **Jump start** will appear and acceleration or quarter mile measurement will be canceled.

Measuring braking

- ▶ Select **Braking**.
- ▶ Select **Start Record**.
Measurement is incremental, in steps of 30 mph (50 km/h) to a standstill. If the braking procedure is started e.g. at a speed of 99 mph (160 km/h), measurement starts as soon as 90 mph (150 km/h) has been reached.

Storing and calling up measurement values

When a measurement has been completed or canceled, the measured time can be stored.

- ▶ After a measurement, select **Save measurement?** .

The stored measurements can be displayed via the **History** menu item.

Editing measurements

- ▶ Select **History**.
- ▶ Highlight the desired measurement.
- ▶ Select  options.
- ▶ Select **Weather** or **Delete**.

- ⓘ The measurements can be displayed by category, e.g. acceleration measurements, by applying a filter.

Calling up the telemetry display

Multimedia system:

↳ **Vehicle** ▶ **TRACK PACE** ▶ **Telemetry**

The telemetry display shows current vehicle data as a digital value and as a diagram. Up to four parameters can be selected that are to be shown in the display.

For example:

- Engine speed
 - Wheel angle
 - Speed
 - Steering angle
- ▶ Set the desired parameters.
 - ▶ Set the time.
The set parameters are evaluated in the diagram for the time set.

- ⓘ The time can range from a minimum of 30 seconds to a maximum of 20 minutes.

Configuring AMG TRACK PACE

Requirements

To use the TRACK PACE app:

- The TRACK PACE app is installed on the mobile end device.
- The mobile end device is connected to the multimedia system via Wi-Fi.

Multimedia system:

↳ **Vehicle** ▶ **TRACK PACE** ▶ **Options**

Setting driver profiles

- ▶ Select **Driver Profile**.
 - ▶ Create a new driver profile.
- or
- ▶ Select an existing driver profile.
The driver profile is activated.

- ① Tracks, laps and times driven are assigned to the active driver profile while driving. For an exact evaluation of your driving style, you should always drive with an active driver profile.

Displaying driver profile statistics

- ▶ Select [Driver Profile](#).

- ▶ Select the desired profile.

The following information is displayed for the selected driver profile:

- Driving time
- Distance driven
- Number of Track Races, Drag Races and laps driven
- Maximum speed

Connecting a mobile device via the TRACK PACE app

The TRACK PACE app makes it possible to record videos and to synchronize them with stored tracks.

- ▶ Select the [TRACK PACE app](#). Already authorized devices are displayed in the list.
- ▶ Select [Authorize new device](#). Available devices are displayed.
- ▶ Start the TRACK PACE app on the device to be connected and follow the instructions.
- ▶ Confirm the authorization prompt.
- ▶ Enter the code displayed on the device. The device is authorized.

or

- ▶ Select a device that is already authorized. The device is de-authorized.

Setting acoustic feedback

- ▶ Select [Acoustic feedback](#).

The following settings are available:

- [Loud](#)
- [Medium](#)
- [Quiet](#)
- [Off](#)

- ▶ Select a setting.

Activating/deactivating additional information

- ▶ Activate or deactivate [Display help](#).

When additional information is activated, popups provide information on the individual menus.

- ▶ Confirm popups with [OK](#) or select [Do not display](#).

Calling up information

- ▶ Select [Info](#).

The following information is displayed:

- Software version
- Memory used
- Total number of tracks saved
- Total number of races driven

Navigation

Switching navigation on

Multimedia system:

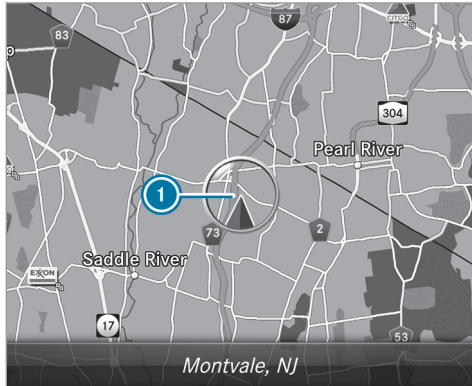

- ▶ Open the application in the multimedia system. The map appears and shows current vehicle position ①.

- ① If a climate control setting is changed, a climate bar appears briefly.

Showing/hiding the navigation menu

Requirements:

- The map displays the current vehicle position.

Multimedia system:

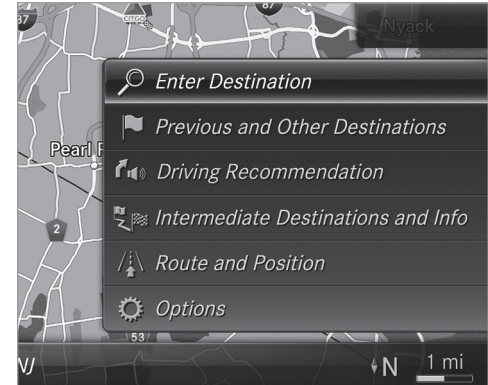

- ▶ **To show:** swipe left on the touchpad or the Touch Control.

or

- ▶ Slide the controller to the left.
- ▶ **To hide:** swipe right on the touchpad or the Touch Control.

or

▶ Slide the controller to the right.

- ① To show or hide lower menu levels, swipe or slide to the left or right as many times as necessary.

Destination entry

Entering a POI or address

⚠ WARNING Risk of distraction from information systems and communications equipment

If you operate information and communication equipment integrated in the vehicle when driving, you will be distracted from the traffic situation. This could also cause you to lose control of the vehicle.

- ▶ Only operate this equipment when the traffic situation permits.
- ▶ If you cannot be sure of this, stop the vehicle whilst paying attention to road

and traffic conditions and operate the equipment with the vehicle stationary.

You must observe the legal requirements for the country in which you are currently driving when operating the multimedia system.

Requirements:

- **For the online search:** Mercedes me connect is available.
- You have a user account for the Mercedes me portal.
- The service is available.
- The service has been activated at an authorized Mercedes-Benz Center.

Further information can be found at: <http://www.mercedes.me>

Multimedia system:

➔ **Navigation**

- ▶ Show the navigation menu.
- ▶ Select  **Enter Destination**.

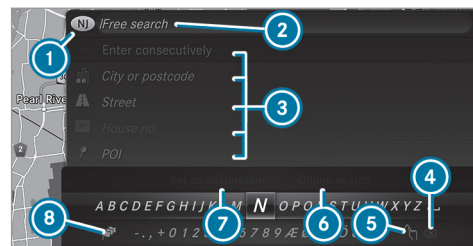

The state or province in which the vehicle is located is set ①.

There are two available methods of destination entry:

- Free search ②
- Search step-by-step ③

Method 1: free search

▶ Enter the POI or address in ②. The entries can be made in any order. During destination entry, suggestions are made by the multimedia system. A selection of destinations appears in a list.

Enter these address elements, for example:

- City, street, house number
- Street, city
- ZIP code
- POI name
- POI category, e.g. [Gas Station](#)
- City, POI name

▶ **To switch to handwriting recognition:**

select  5.

▶ Write the character on the touchpad.

i The function is available when a touchpad is installed.

▶ **To switch to character selection:** press the  button.

or

▶ Press the touchpad.

▶ **To delete an entry:** select  4 (if available).

Use the following options:

- Press briefly: deletes the last character entered or the last suggestion adopted.

- Press and hold: deletes the entire entry.

▶ **To set the language:** select  8.

▶ Select the language.

i This function is useful for countries in which several character sets are supported. An example is Russia, which uses Cyrillic and Latin characters.

▶ **To call up the online search function:**

select [Online Search](#) 6.

Once an Internet connection is established, a list appears. It shows online destinations related to the previous entry.

Online destinations are provided by the Internet service provider.

▶ Select the online destination.

or

▶ Enter the online destination or a 3 word address in the input line.

i Enter a 3 word address (→ page 227). Online search is not available in all countries.

▶ **To call up the list:** press the  button.

or

▶ If the top line of the character bar is highlighted, navigate upwards.

▶ Select the destination in the list.

▶ **To adopt a destination:** select 7 [Select Destination](#).

If there are several listings for a destination, a list appears.

▶ Select the destination.

The destination address is shown.

Method 2: search step-by-step

▶ Press  button.

or

▶ If the top line of the character bar is highlighted, navigate upwards.

The character bar is hidden. [City or ZIP](#) is highlighted. Additional entry fields, e.g. for [POI](#), are available.

▶ Select [City or ZIP](#).

The character bar appears.

▶ Enter the city or the ZIP code. During destination entry, suggestions are made by the multimedia system. A selection of destinations appears in a list.

The address entries can be made in any order, for example:

- **City or ZIP, Street, House No.**
Enter an intersecting street, if available.
- **Street, City or ZIP**
- **POI, e.g. Gas Station, City or ZIP**

① During destination entry, use the following functions:

- Switch to handwriting recognition.
- Switch to character selection.
- Delete an entry.

An entry, e.g. **POI**, can be deleted with  in a step-by-step search. Navigate to the left to do so.

- Call up the online search function (if available).
- Call up a list.

The functions are described in the free search.

- ▶ **To change the state/province:** select the state or the province.
- ▶ Enter the state or the province. You only need to enter the first character.
- ▶ Select the state or the province in the list.
- ▶ **To change the country:** select the country.
- ▶ Enter the country. You only need to enter the first character.
- ▶ Select the country on the list.
- ▶ **To adopt a destination:** select **Select Destination**.
If there are several listings for a destination, a distance-orientated list appears.
- ▶ Select the destination.
The destination address is shown.

Selecting previous destinations

Multimedia system:

↳ **Navigation**

▶  **Previous and Other Destinations**

▶ Select **Previous Destinations**.

▶ Select the destination.
The destination address is shown.

or

▶ If favourites have been saved already (→ page 237), select **From My Favorites**.

▶ Select the favourite.
The destination address is shown.

Selecting a POI

Multimedia system:

↳ **Navigation**

▶  **Previous and Other Destinations**

▶ **POIs**

▶ Select the category.

or

▶ Select **All Categories** and the category.
If route guidance is not active: the search begins in the vicinity of the current vehicle

position. The list is sorted by distance in ascending order.

The POIs show the following information:

- name of POI
- linear distance to the POI
- the direction of the linear distance to the POI (arrow) is displayed when searching for the vehicle's current position

▶ Select the POI.

▶ **Route guidance is active:** select the search position prior to choosing a POI (see example).

▶ If intermediate destinations are set, these can also be selected as the search position after selecting [Near Destination](#).

Filtering displays for POIs

▶ Enter the search term in  **Search:**. The results list shows relevant POIs.

▶ Select . The first POI in the list is highlighted.

▶ Select the POI.

Example: setting the search position for the parking category during active route guidance

▶ Select [In the Vicinity](#), [Near Destination](#) or [Along the Route](#).

The list shows the located POIs or opens an overview of the route destination after selecting [Near Destination](#).

▶ Select the POI.

▶ Select [Near Destination](#): select the intermediate destination or the destination.

Starting an automatic gas station search Requirements:

- The automatic gas station search is activated (→ page 231).

Driving situation

Route guidance is active. The fuel level in the fuel tank reaches the reserve fuel level.

The [Reserve Fuel Do you want to start a search for surrounding gas stations?](#) message is shown.

▶ Select [Yes](#).

The automatic gas station search begins. The available gas stations along the route or in the vicinity of the vehicle's current position are displayed.

▶ Select the gas station.

The address of the gas station is displayed.

▶ If route guidance is not active, select [Start Route Guidance](#).

The selected gas station is set as the destination. Route guidance begins.

or

▶ If route guidance is active, select [Start New Route Guidance](#) or [Set as Next Way Point](#).

[Start New Route Guidance](#): the selected gas station is set as a new destination. The previous destinations and intermediate destinations are deleted. Route guidance to the gas station begins.

[Set as Next Way Point](#): the selected gas station is set as the next intermediate destination. Route guidance begins.

▶ **If there are already four intermediate destinations:** select **Yes** in the prompt.

The selected gas station is entered into position 1 of the intermediate destinations menu. Intermediate destination 4 is deleted. Route guidance begins.

Entering an intermediate destination

Requirements:

- A destination is entered.

Multimedia system:

↳ **Navigation** ▶ **Way Points and Info**

- ▶ Select **Search for Way Point**.
- ▶ Enter the intermediate destination as a POI or address (→ page 222).
- ▶ Select the intermediate destination.
- ▶ Select **Set as Destination**.

or

- ▶ Select an intermediate destination using  **Enter Destination** during route guidance.
- ▶ Select **Set as Next Way Point** after entering the destination.



Editing intermediate destinations

Requirements:

- The destination and at least one intermediate destination have been entered.

Multimedia system:

↳ **Navigation** ▶ **Way Points and Info**

- ▶ **To call up the map:** highlight the destination or the intermediate destination.
- ▶ Select  **Map** .
- ▶ Move the map (→ page 241).
- ▶ Select destination on the map (→ page 228).
- ▶ **To change the order of destinations:** highlight the destination or the intermediate destination.
- ▶ Select  **Move** .
- ▶ Move the intermediate destination to the desired position.
- ▶ Press the Touch Control, the controller or the touchpad.
- ▶ **To delete a destination:** highlight the destination or the intermediate destination.

- ▶ Select  **Delete**.

Calculating a route with intermediate destinations

Requirements:

- The destination and at least one intermediate destination have been entered.

Multimedia system:

↳ **Navigation** ▶ **Way Points and Info**

- ▶ Select **Start New Route Guidance**.
The route is calculated with the set intermediate destinations.

Selecting a contact for destination entry

Requirements:

- A mobile phone is connected to the multimedia system (→ page 248).
- Contacts have been downloaded (→ page 252).

Multimedia system:

↳ Navigation

▶▶  Previous and Other Destinations

▶▶ Contacts

- ▶ Select the contact.
The contact details are displayed.
- ▶ Select the address.
The **Please Wait...** message appears.
The search is carried out first online and then in the multimedia system database.
- ▶ Select the destination.

Filtering displays for contacts

- ▶ Enter a name or telephone number, for example, into the search field.
- ▶ Select **OK**.
The first contact in the list is highlighted.
- ▶ Select the contact.
- ▶ Select the address.

Entering geo-coordinates

Multimedia system:

↳ Navigation

▶▶  Previous and Other Destinations

▶▶ Geo-coordinates

- ▶ Enter geo-coordinates as latitude and longitude coordinates in degrees, minutes and seconds.
The map shows the position.
- ▶ Confirm the entry.
- ▶ **To calculate a route:** select **Start Route Guidance**.
- ▶ If a route has already been created, select **Start New Route Guidance** or **Set as Way Point**.

Entering the destination as a 3 word address Requirements:

- Searching for a destination using 3 word addresses is possible in the online search (→ page 222).
- There is an Internet connection.

- ⓘ Searching for a destination using 3 word addresses is not possible in all countries.

Multimedia system:

↳ Navigation ▶▶  Enter Destination

- ▶ Select **Online Search**.
- ▶ Enter the destination address as a 3 word address. Separate each of the words with a full stop.
The search results are displayed.
- ▶ Select the destination in the list.
The destination address is shown. The route can be calculated.
- ⓘ 3 word addresses from what3words are an alternative addressing system for multilingual georeferencing of global locations with a resolution of three meters. Using this grid, locations on the Earth's surface are included which do not have a building address such as street and house number, for example. The Empire State Building has this language dependent 3 word address:
 - English: **parade.help.bleat**
 - French: **commun.verbe.bisquer**

- Spanish: **suertes.diga.pesca**

3 word addresses are unique, easy to remember and suffice for most routine applications.

You can convert addresses to 3 word addresses and back again:

- at the website <http://what3words.com>
- in the what3words apps

Selecting a destination on the map

Multimedia system:

Navigation ►►  Options

- Select **Map Menu**.

or

- If the map is displayed in full screen mode, press the central control element. The map menu appears.
- Select "move map" in map menu  (→ page 240).
- Swipe in any direction on the Touch Control or touchpad.

or

- Slide the controller in any direction. The map moves in the corresponding direction under the crosshair. The more you move your finger away from the starting position on the touchpad, the faster the map moves.
- Press the Touch Control, the controller or the touchpad. If several destinations are located around the crosshair, a list shows the available POIs and roads. If a destination is located exactly on the crosshair, the destination address is displayed.
- Select the destination in the list. The destination address is shown.

Setting the map orientation to 2D or 3D

- Highlight **Map Orientation: 2D/3D**.
- Press the Touch Control, the touchpad or the controller. The map will be displayed in the selected map orientation.

Showing traffic messages in the vicinity of the map

- Select **Traffic Messages for the Vicinity**. The map appears.
- Swipe left or right on the touchpad.

or

- Slide the controller to the left or right. The previous or next traffic incident is highlighted on the map. Information on the traffic incident is displayed.

 Traffic reports are not available in all countries.

Showing POIs in the vicinity of the map

- Select **POIs in the Vicinity**.
- Swipe left or right on the touchpad.

or

- Slide the controller to the left or right. The previous or next POI is highlighted on the map. The name or the address is shown.
- **To filter the display by POI category:** swipe down on the Touch Control or the touchpad.

or

- ▶ Slide the controller down.
- ▶ Select the POI category.

① **User Defined** allows personal POI symbols to be selected (→ page 241).

Route

Calculating a route Requirements:

- The destination has been entered.
- The destination address is shown.
- ▶ If route guidance is not active, select **Start Route Guidance**.
The route to the destination is calculated. The map shows the route. Route guidance then begins.

or

- ▶ If route guidance is active, select **Start New Route Guidance** or **Set as Next Way Point**.
Start New Route Guidance: the selected destination address is set as a new destination. The previous destinations and intermediate





destinations are deleted. Route guidance to the new destination begins.

Set as Next Way Point: the selected destination address is set as the next intermediate destination. Route guidance begins.

Taking alternative routes into consideration

- ▶ Select an alternative route (→ page 231).

Other menu functions

- ▶ **To save the destination**: select  **Store** in "Previous Destinations".
- ▶ **To display on the map**: select  **Map**.
- ▶ **To call a telephone number**: select  **Call** (if available).
- ▶ **To call up an Internet address**: select  **www** (if available).

Selecting a route type

Multimedia system:

↳ **Navigation** ▶▶  **Route and Position**

- ▶ Select **Route Settings**.

- ▶ Select the route type.

If route guidance is active, the new route is calculated with the new route type.

If route guidance is not active, the next route is calculated with the new route type.

You can choose from the following route types:

- **Eco Route**

An economical route is calculated. The journey time may be somewhat longer than for quicker routes.

The symbol for the current vehicle position is displayed in green.

- **Fast Route**

A route with a quick journey time is calculated.

- **Short Route**

A route with a short driving distance is calculated.

Automatic Traffic Jam Avoidance can be switched on or off for these route types. If **Automatic Traffic Jam Avoidance** is switched

on, [Ask in the Event of Traffic Jam Avoidance](#) can be selected.

The [Automatic Traffic Jam Avoidance](#) and [Ask in the Event of Traffic Jam Avoidance](#) settings are not available in every country.

The settings enable the following:

- [Automatic Traffic Jam Avoidance](#)

The route is calculated with the currently set route type.

Traffic reports via Live Traffic Information are taken into account.

Live Traffic Information is not available in all countries.

- [Ask in the Event of Traffic Jam Avoidance](#)

A prompt appears when a new route is detected with a shorter journey time based on traffic reports. You can continue to use the current route or use the dynamic route instead.

Selecting route options

Multimedia system:

- ▶  [Navigation](#) ▶  [Route and Position](#)
- ▶ [Avoid Options](#)

Avoiding areas

- ▶ Select [Areas](#) (→ page 243).

Avoiding highways, ferries, motorail trains, tunnels, unpaved roads

- ▶ Select or deselect avoid option.

Using toll roads

- ▶ Select [Use Toll Roads](#).
- ▶ Select [Cash](#) or [Electronic Billing](#) or [Off](#).
The route takes into account roads that require the payment of a usage fee (toll).
If [Off](#) is selected, toll roads are not taken into account.

The selected route options cannot always be implemented. Therefore, a route may include a ferry, for instance, even though the avoid [Ferries](#) option is enabled. A message appears and you will hear a corresponding message.

Using carpool lanes

- ▶ Select [Number of Occupants in the Vehicle](#).
- ▶ Select number.
When using carpool lanes, observe the applicable legal requirements as well as any conditions pertaining to when and where such lanes may be used. Carpool lanes may only be used if certain conditions are met.

These route options are not available in every country.

Selecting notifications

Multimedia system:

- ▶  [Navigation](#) ▶  [Options](#)
- ▶ [Announcements](#)

- ▶ Switch an announcement on or off .

You can choose from the following announcements:

- [Announce Traffic Warnings](#)
This function is not available in all countries.
- [Announce Street Names](#)

The multimedia system announces the names of the roads that will follow the upcoming change of direction.

This function is not available in all countries and languages.

Displaying destination information

Requirements:

- A destination is entered.

Multimedia system:

→ **Navigation**

- ▶ Select **Way Points and Info**.

The following information is displayed:

- Intermediate destinations and destination
 - The route can also include up to four intermediate destinations.
- Name, address
- Remaining driving distance
- Time of arrival

Selecting an alternative route

Multimedia system:

→ **Navigation** →  **Route and Position**

- ▶ Select **Alternative Route**.
The routes are displayed in accordance with the setting made in the route settings.
The currently selected route is shown with a dark blue line.
- ▶ Select the alternative route.

Switching the automatic gas station search on/off

Multimedia system:

→ **Navigation** →  **Options**

- ▶ Switch **Reserve Fuel** on or off .
Switched on : when the fuel reserve level is reached, a prompt appears asking whether you want to start searching for gas stations.

Using automatic gas station search

Requirements:

The automatic gas station search is activated (→ page 231).

The prompt **Reserve Fuel Do you want to start a search for surrounding gas stations?** appears.

- ▶ Select **Yes**.
The automatic gas station search begins. The available gas stations along the route or in the vicinity are displayed.
- ▶ Select the gas station.
- ▶ When there is no route, the gas station is set as the destination.

or

- ▶ When there is a route, the gas station is set as the next intermediate destination.

Starting the automatic service station search

Requirements:

- ATTENTION ASSIST and the **Suggest Rest Area** function are activated (→ page 164).

Driving situation

The **ATTENTION ASSIST Do you want to search for a rest area?** message is shown.

- ▶ Select **Yes**.
The service station search starts. The available service stations along the route or in the vicinity of the vehicle's current position are displayed.
 - ▶ Select the service station.
The service station address is displayed.
 - ▶ If route guidance is not active, select **Start Route Guidance**.
The selected service station is set as a destination. Route guidance begins.
- or
- ▶ If route guidance is active, select **Start New Route Guidance** or **Set as Next Way Point**.
Start New Route Guidance: the selected service station is set as a new destination. The previous destination and all intermediate destinations are deleted. Route guidance to the service station begins.
Set as Next Way Point: the selected service station is set as the next intermediate destination. Route guidance begins.

Route guidance

Notes on route guidance

⚠ WARNING Risk of distraction from operating integrated communication equipment while the vehicle is in motion

If you operate communication equipment integrated in the vehicle when driving, you will be distracted from the traffic situation. This could also cause you to lose control of the vehicle.

- ▶ Only operate this equipment when the traffic situation permits.
- ▶ If you cannot be sure of this, stop the vehicle whilst paying attention to road and traffic conditions and operate the equipment with the vehicle stationary.

You must observe the legal requirements for the country in which you are currently driving when operating the multimedia system. Route guidance begins once a route has been calculated.

The road and traffic rules and regulations always have priority over multimedia system driving instructions.

The following driving instructions can be used:

- Navigation announcements
- Route guidance displays
- Lane recommendations

If you do not follow the driving instructions or if you leave the calculated route, a new route is calculated automatically.

Driving instructions may differ from the actual road and traffic conditions if:

- The route is diverted
- The direction of a one-way street has been changed

For this reason, you must always observe road and traffic rules and regulations during your journey as well as the prevailing traffic conditions.

The route may differ from the ideal route due to the following:

- Roadworks

- Incomplete digital map data

Notes on GPS reception

The correct function of the navigation system depends amongst other things on GPS reception. In certain situations GPS reception can be impaired, defective or even not possible, e.g. in tunnels or in parking garages.

Changing direction overview

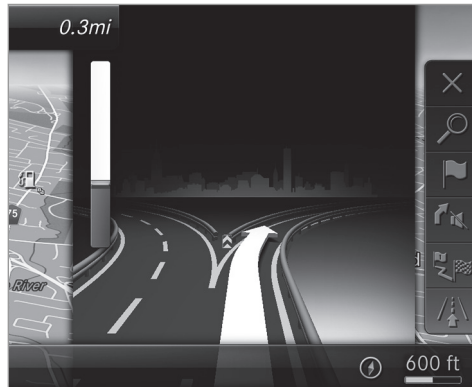

There are three phases when changing direction:

- Preparation phase
If there is enough time between the changes of direction, the multimedia system prepares you for the upcoming change of direction. A navigation announcement is issued, e.g. "Prepare to turn right".
The map appears in full-screen mode.
- Announcement phase
The multimedia system announces the upcoming change of direction, e.g. by announcing "Turn right in 300 ft (100 m)".
The display is split into two parts. The map is displayed on the left; on the right, there is a detailed image of the intersection or a 3D image of the upcoming change of direction.
- Change-of-direction phase
The multimedia system announces the imminent change of direction, e.g. by announcing "Now turn right".
The display is split into two parts.
The vehicle has successfully changed direction when the light-color bar on the right

drops down to 0 feet (0 m) and the current vehicle position symbol has reached the highlighted change-of-direction point.

When the change of direction is complete, the map appears in full-screen mode.

- ① Changes of direction are also shown in the Instrument Display.

Lane recommendations overview

This display appears for multi-lane roads.

If the digital map contains the relevant data, the multimedia system can display lane recommendations for the next two changes of direction.



- ① Recommended lane
- ② Possible lane
- ③ Lanes not recommended

The following lanes are displayed:

- Recommended lane ①

In this lane, you will be able to complete both the next change of direction and the one after that.

- Possible lane ②

In this lane, you will only be able to complete the next change of direction.

- Lane not recommended ③

In this lane, you will not be able to complete the next change of direction without changing lane.

During the change of direction, new lanes may be added.

- ① Lane recommendations can also be shown in the Instrument Display.

Overview of destination reached

Once the destination is reached, you will see the  checked flag. Route guidance is finished.

When an intermediate destination has been reached, you will see the intermediate destination flag with the number of your  intermediate destination. After this, route guidance is continued.

Switching navigation announcements on/off Requirements:

- Route guidance is active.

- ▶ **To switch off:** press the volume control on the multifunction steering wheel during a navigation announcement (→ page 203). The **Voice Guidance has been deactivated.** message appears.

or

- ▶ Show the navigation menu (→ page 221).

- ▶ Select  **Voice Guidance** . The symbol changes to .

- ▶ **To activate:** select  **Voice Guidance** . The current navigation announcement is played.

- ① In the following situations, navigation announcements are switched on automatically:

- A new route guidance is started.
- The route is recalculated.

- ① You can add and call up this function as a favorite under **Voice Guidance On/Off**.

Switching navigation announcements on/off during a phone call

- ▶ Select **System**.

- ▶ Select  **Audio**.
- ▶ Select **Navigation and Traffic Announcements**.
- ▶ Switch **Voice Guidance During Call** on or off .

Adjusting the volume of navigation announcements

Requirements:



- Route guidance is active.
- ▶ **On the multifunction steering wheel or on the multimedia system:** turn the volume control on the multifunction steering wheel during a navigation announcement.

or

- ▶ During a navigation announcement press the volume rocker switch on the center console up or down (→ page 203).

- ① In the following situations, the volume is raised to the maximum volume or lowered to the minimum volume:
 - A new route guidance is started.
 - The route is recalculated.

- ① The minimum volume can be individually set at an authorized Mercedes-Benz Center.

- ▶ **Via system settings:** select **System**.
- ▶ Select  **Audio**.
- ▶ Select **Navigation and Traffic Announcements**.
- ▶ Select **Voice Guidance Volume**.
- ▶ Set the volume.
- ▶ **To switch audio fadeout on/off during navigation announcements:** select **System**.
- ▶ Select  **Audio**.
- ▶ Select **Navigation and Traffic Announcements**.
- ▶ Switch **Audio Fadeout During Voice Guidance** on or off .



Repeating navigation announcements

Requirements:

- A route has already been created.
- Route guidance is active.

Multimedia system:

Navigation

- ▶ Select  **Voice Guidance**.
- ▶ Select  **Voice Guidance**.
The current navigation announcement is repeated.

- ① You can add and call up this function as a favorite under **Repeat Voice Guidance**.

Canceling route guidance

Requirements:

- A route has already been created.
- Route guidance is active.

Multimedia system:

Navigation

- ▶ Select  **Cancel Route Guidance**.

Overview of route guidance to an off-road destination

An off-road destination is within the digital map. The map contains no roads that lead to the destination.

You can enter geo-coordinates or a three word address for off-road destinations on the map. Route guidance guides you for as long as possible with navigation announcements and displays on roads that are known to the multimedia system.

Shortly before you reach the last known position on the map, you will hear the "Please follow the direction arrow" announcement. The display shows a direction arrow and the linear distance to the destination.

Overview of route guidance from an off-road location to a destination

Off-road position: the current vehicle position is located within the digital map on roads that are not available.

When route guidance begins the following displays appear:

- The **Road Not Mapped** message is shown.
- A direction arrow showing the linear direction to the POI.

When the vehicle is back on a road known to the multimedia system, route guidance continues as normal.

Overview of off-road status during route guidance

Due to roadworks, for example, there may be differences between the data on the digital map and the actual course of the road. In such cases, the multimedia system will temporarily be unable to locate the vehicle's current position on the digital map. The vehicle is off-road.

When the vehicle is off-road, the following displays are shown:

- the **Road Not Mapped** message
- a direction arrow showing the linear direction to the POI

When the vehicle is back on a road known to the multimedia system, route guidance continues as normal.

Destination

Saving the current vehicle position

Multimedia system:

Navigation

- ▶ If the map is displayed in full screen mode, press the central control element. The map menu appears.
- ▶ Select ❶ on the map menu (→ page 240). The current vehicle position is saved to the "Previous destinations" memory.

Storing a map position

Multimedia system:

Navigation

The map is in full-screen mode.

- ▶ Select "move map" in map menu ❷ (→ page 240).
- ▶ Select a position on the map. If multiple entries are available for a map position, a list appears.
- ▶ Highlight an entry.



- ▶ Select  **Store in "Previous Destinations"** .
The map position is saved to the "Previous destinations" memory.



Editing the previous destinations

Multimedia system:

↳ Navigation

- ▶▶  **Previous and Other Destinations**
- ▶▶ **Previous Destinations**

- ▶ Highlight one of the previous destinations.
- ▶ **To save as a favorite:** select  **Save My Favorite** .
The favorites are displayed.
- ▶ Move the favorite to the desired position.
If a favorite has already been added at this position, it will be overwritten.
- ▶ **To save as "Home" address:** select  **Save as "Home"** .
- ▶ **To save as "Work" address:** select  **Save as "Work"** .

- ▶ **To delete a single or all destinations:**
select  **Delete** or **Delete All**.
A prompt appears.
- ▶ Select **Yes**.
- ▶ **To display destination information:** select  **Details**.

Using external destinations

External destinations can be received from the following sources:

- Mercedes-Benz Apps
 - Door-to-door navigation with Companion app (USA)
- ⓘ Received destinations are saved in the previous destinations.

A prompt appears on the media display.

- ▶ **A destination has been received without picture information:** select **Yes**.
- ▶ If route guidance is not active, select **Start Route Guidance**.
The route to the destination is calculated.
The map shows the route. Route guidance then begins.

or

- ▶ If route guidance is active, select **Start New Route Guidance** or **Set as Next Way Point**.
Start New Route Guidance: the received destination address is set as a new destination.
The previous destinations and intermediate destinations are deleted. Route guidance to the new destination begins.
Set as Next Way Point: the received destination address is set as the next intermediate destination. Route guidance begins.
- ▶ **A destination has been received with picture information:** select **Start Route Guidance**.
Route guidance starts.

Route guidance with current traffic reports

Traffic information overview

Traffic reports are received using Live Traffic Information and are used for route guidance. This service is unavailable in some countries.

There may be differences between the traffic reports received and the actual road and traffic conditions.

Important information on Live Traffic Information:

- Current traffic reports are received via the Internet connection.
- The traffic situation is updated at short, regular intervals.
- The subscription information shows the status (→ page 238).

Information on the vehicle's position is regularly sent to Daimler AG. The data is immediately rendered anonymous by Daimler AG and forwarded to the traffic data provider. Using this data, traffic reports relevant to the vehicle's position are sent to the vehicle. The vehicle acts as a sensor for the flow of traffic and helps to improve the quality of the traffic reports.

If you do not wish to transmit your vehicle position, you can have this service deactivated at an authorized Mercedes-Benz Center.

Displaying subscription information Requirements:

- The vehicle is equipped with Live Traffic Information.

Multimedia system:

Navigation ▶ Options

The subscription expiration date is automatically displayed:

- one month before the expiration date.
- one week before the expiration date.
- on the expiration date.

▶ **To display manually:** select [Live Traffic Subscription Info](#).

Depending on the status, one of the following messages appears:

- the period of validity for the subscription is displayed.
- the subscription has expired.

i The subscription can be extended:

- at an authorized Mercedes-Benz Center

- via an MB Info call to the Mercedes-Benz Customer Assistance Center

Displaying the traffic map Requirements:

- For Live Traffic Information: the vehicle is equipped with a communication module featuring an activated, integrated SIM card.
- When the vehicle is started, the communication module automatically establishes an Internet connection. Traffic information is made available shortly afterwards.

Multimedia system:

Navigation ▶ Options
▶ Map Menu

- ▶ Alternatively: if the map is displayed in full screen mode, press the Touch Control, the controller or the touchpad. The map menu appears.
- ▶ Activate  .

The traffic map shows the following information, for example:

- traffic incidents, for example:

- roadworks
- road blocks
- warning messages

The symbols for traffic incidents are displayed in color (on the route) or gray (off the route).

- traffic flow information:
 - traffic jam (red line)
 - slow-moving traffic (orange line)
 - heavy traffic (yellow line)
 - free-flowing traffic (green line)
- display for traffic delays on the route lasting at least one minute
- warning message symbols:
 -  symbol
 - additional road safety notes when approaching a traffic incident, e.g. the end of a traffic jam

If the vehicle approaches a danger area on the route, a warning message is dis-

played on the map. A warning message may also be issued (→ page 240).

Displaying traffic incidents

Multimedia system:

- [Navigation](#) →  [Options](#)
- [Map Content](#)

- ▶ Activate [Traffic Incidents](#).
Roadworks, road blocks, local area reports (e.g. fog) and warning messages are displayed.

Activating free flow and traffic display

- ▶ Activate [Free Flowing Traffic](#) and [Traffic Delays](#).
- ⓘ The traffic delay is displayed for the current route. Traffic delays lasting one minute or longer are taken into consideration.

Displaying details

- ▶ Displays the traffic map (→ page 238).
- ▶ Moves the map (→ page 241).

- ▶ When a traffic report symbol is under the crosshair, press on the central control element.
The traffic report details are displayed.

or

- ▶ Press on the central control element.
- ▶ Select [Information on Traffic Reports](#).
The map shows the traffic report symbols in the vicinity.
Traffic report information is displayed in the status line:
 - Traffic report symbol
 - Reason for the traffic report, e.g. traffic congestion
 - Warning message (highlighted in red)
- ▶ **To select a traffic report symbol:** select [Next](#) or [Previous](#).
- ▶ Press on the central control element.
The traffic report details are displayed.

Issuing hazard warnings

Multimedia system:

→ Navigation → ⚙ Options

→ Announcements

- ▶ Activate **Announce Traffic Warnings.**
Warning messages are issued and tailbacks which pose a risk are announced.

Map and compass

Map and compass overview

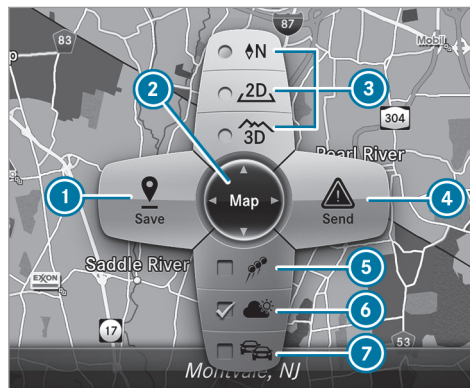

- ① Saves the current vehicle position
- ② Moves the map
- ③ Selects the map orientation and map view
- ④ Selects the function depending on the equipment:
 - Sends a hazard warning via Car-to-X.

- Filters the display of POIs in the vicinity according to POI category

- ⑤ Switches the display of personal POI symbols on the map on or off
- ⑥ Switches one of the following displays on or off depending on the equipment:
 - Weather information
 - Satellite map
 - Traffic incidents
- ⑦ Switches the traffic map display on or off

The map and satellite images are shown in globe projection. This allows for a realistic map display in all map scales. The map uses elevation modeling.

Depending on the map data, important buildings in many cities are depicted realistically on the map in small map scales (e.g. 1/32 mi (20 m), 1/16 mi (50 m)). Other buildings are shown as models.

- ① You can set the unit of measurement of the map scale (→ page 211).

If online information is available, fuel prices and the availability of parking spaces in parking garage are displayed, for example.

i Requirements:

- Mercedes me connect is available.
- You have a user account for the Mercedes me portal.
- The service has been activated at an authorized Mercedes-Benz Center.

Further information can be found at: <http://www.mercedes.me>

i The online information is not available in all countries.

If **Display in COMAND** is activated in Traffic Sign Assist (→ page 166), speed limits and overtaking restrictions are displayed on the map.

i Company logos displayed on the map are trademarks of the respective companies and used solely for the purpose of indicating the locations of these companies. The use of such logos on the map does not indicate approval of, support of or advertising by

these companies for the navigation system itself.

Setting the map scale

Requirements:

- The map is shown.

Multimedia system:

↳ [Navigation](#)

i You can set the unit of measurement of the map scale (→ page 211).

Moving the map

Multimedia system:

↳ [Navigation](#) ▶  [Options](#)

▶ [Map Menu](#)

▶ Alternatively, if the map is displayed in full screen mode, press the central control element. The map menu appears.

▶ Select "Move map" in map menu  (→ page 240).

Selecting the map orientation

Multimedia system:

↳ [Navigation](#) ▶  [Options](#)

▶ [Map Menu](#)

▶ Alternatively, if the map is displayed in full screen mode, press the central control element. The map menu appears.

▶ In map menu , select **N**, **2D** or **3D** (→ page 240).

- **N**: the 2D map view is displayed so that north is always at the top.
- **2D**: the 2D map view is aligned to the direction of travel.
- **3D**: the 3D map view is aligned to the direction of travel.

Selecting POI symbols

Multimedia system:

↳ [Navigation](#) ▶  [Options](#)

▶ [Map Content](#)

▶ Select **POI Symbols**.

The **•** dot indicates the current setting.

Standard displays symbols of predefined categories on the map.

User Defined allows you to personally select the symbols for the available categories.

None switches the display off.

▶ Select a setting.

▶ **User Defined**: select categories.

The POI symbols of the selected categories are displayed or not displayed .

Selecting the display of text information in the map

Multimedia system:

↳ **Navigation** ▶  **Options**

▶ **Text Information**

▶ Select text information.

Current Street shows the street you are currently driving on at the bottom of the display.

When the map is moved, the following information appears under the crosshair:

- Street name
- POI name
- Area name

Geo-coordinates displays the following information:

- Longitude and latitude
- Elevation

The elevation shown may deviate from the actual elevation.

- Number of satellites from which a signal can be received

When the map is moved, this information does not appear.

Climate Control displays the current climate control settings.

None switches the display off.

Displaying the next intersecting street Requirements:

- Route guidance is not active.

Multimedia system:

↳ **Navigation** ▶  **Options**

▶ Activate **Next Intersecting Street**.

The name of the next intersecting street will be displayed at the upper edge of the display.

Displaying the map version

Multimedia system:

↳ **Navigation** ▶  **Options**

▶ Select **Map Version**.

▶ Select **Details**.

 Information about new versions of the digital map can be obtained from an authorized Mercedes-Benz Center.

Overview of avoiding an area

You can define areas along a route that you would like to avoid.

The route can include an area that is to be avoided in the following situations:

- the destination is located in an area that is to be avoided
- if freeways are located within the area that is to be avoided
Freeways are always taken into account for the route.
- there is no sensible alternative route

Avoiding a new area

Multimedia system:

- Navigation >>  Route and Position
- >> Avoid Options >> Areas

- ▶ Select **Avoid New Area**.
- ▶ **To search for an area via the map:** select **Using Map**.
- ▶ Move the map

or

- ▶ **To search for an area using an address:** select **Address Entry**.
- ▶ Enter the address.
- ▶ Select **Select Destination**.
The map appears.

Changing an area

Multimedia system:

- Navigation >>  Route and Position
- >> Avoid Options >> Areas

- ▶ Highlight an area in the list.
- ▶ Select  **Edit**.

Moving the area on the map

- ▶ Swipe in any direction on the Touch Control or touchpad.

or

- ▶ Slide the controller in any direction.

Changing the size of the area

- ▶ **To start:** press the Touch Control, the touchpad or the controller.
- ▶ **To change:** swipe up or down on the Touch Control or the touchpad.

or

- ▶ Slide the controller up or down.
- ▶ **To stop:** press the Touch Control, the touchpad or the controller.



Taking the area for the route into account

- ▶ Avoid an area in the list.
If route guidance is active, a new route is calculated.
- ▶ If there is no route yet, the setting is carried over to the next route guidance.

Deleting one or all areas

Multimedia system:

- Navigation >>  Route and Position
- >> Avoid Options >> Areas

- ▶ Highlight an area in the list.
- ▶ Select  **Delete** or  **Delete All**.
- ▶ Confirm the prompt with **Yes**.
One or all areas are deleted.

Map data update overview**Updating at the authorized Mercedes-Benz Center**

The digital maps generated by the map software become outdated in the same way as conventional road maps. Optimal route guidance can only be provided by the navigation system in conjunction with the most up-to-date map data. Information about new versions of the digital map can be obtained from an authorized Mercedes-Benz Center.

You can receive updates to the digital map there.

Online map update

The online map update service from Mercedes me connect can be used to update map data.

- ❗ The online map update service is not available in all countries.

The following options are available for the update:

- the automatic map update updates map data for one region.
For automatic map updates **Automatic Online Update** must be activated in the system settings (→ page 215).
- the manual map update updates map data for several or all regions.

Further information on the online map update is available at an authorized Mercedes-Benz Center or at <http://www.mercedes.me>.

Further information on updates: http://manuals.daimler.com/baix/cars/connectme/en_GB/index.html.

Overview of map data

Your vehicle is supplied with map data at the factory. Depending on the country, map data for

your region is either pre-installed or the map data is supplied on a data storage medium.

If the map data on your vehicle has been installed at the factory and you wish to reinstall it, you do not need to enter the activation code.

For map data that you have purchased in the form of a data storage medium, you must enter the accompanying activation code.

- ❗ If you save the map data on a data storage medium with the online map update service, no entry is required. The activation code is stored on the data storage medium during the downloading process.

Observe the following when entering the activation code:

- The activation code can be used for one vehicle
- The activation code is not transferable
- The activation code has six digits

In the event of the following problems, please contact an authorized Mercedes-Benz Center:

- The multimedia system does not accept the activation code

- You have lost the activation code

Displaying the compass

Multimedia system:

→ **Navigation** ▶  **Route and Position**

- ▶ Select **Compass**.

The compass display shows the following information:

- the current direction of travel with bearing (360° format) and compass direction
- longitude and latitude coordinates in degrees, minutes and seconds
- height (rounded)
- number of GPS satellites from which a signal can be received

Setting the map scale automatically

Multimedia system:

→ **Navigation** ▶  **Options**

The map scale is set automatically depending on your driving speed.

For journeys in cities with detailed city models, a map view from the driver's perspective is used.

- ▶ Switch **Auto Zoom** on or off .
- ⓘ The automatically selected map scale can be changed manually for a short time. The setting is reset automatically after a few seconds.

Displaying the satellite map

Multimedia system:

↳ **Navigation** ▶  **Options**

▶ **Map Content**

- ▶ Switch **Satellite Map** on or off .
- or

- ▶ If satellite map display  is available in the map menu, switch it on or off (→ page 240).
Switched on : satellite maps are displayed in map scales of 2 mi (2 km) or less.

Switched off : satellite maps are not displayed in map scales from 2 mi (2 km) to 10 mi (10 km).

- ⓘ Satellite maps for these map scales are not available in all countries.

Displaying weather information Requirements:

- Mercedes me connect is available.
- You have a user account for the Mercedes me portal.
- The service is available.
- The service has been activated at an authorized Mercedes-Benz Center.

Further information can be found at: <http://www.mercedes.me>

Multimedia system:

↳ **Navigation** ▶  **Options**

▶ **Map Content**

- ▶ Activate **Weather Information** .
- or

- ▶ If weather information display  is available in the map menu, activate (→ page 240) it.
Current weather information is displayed on the navigation map, e.g. temperature or cloud cover.

- ⓘ Weather information is not available in all countries.

Calling up the Digital Operator's Manual (navigation)

Calling up information on navigation

Multimedia system:

↳ **Navigation** ▶  **Options**

▶ **Navigation Info**

- ▶ Select the topic.

Telephone

Telephony

Notes on telephony

⚠ WARNING Risk of distraction from operating integrated communication equipment while the vehicle is in motion

If you operate communication equipment integrated in the vehicle when driving, you will be distracted from the traffic situation.

This could also cause you to lose control of the vehicle.

- ▶ Only operate this equipment when the traffic situation permits.
- ▶ If you cannot be sure of this, stop the vehicle whilst paying attention to road and traffic conditions and operate the equipment with the vehicle stationary.

⚠ WARNING Risk of an accident from operating mobile communication equipment while the vehicle is in motion

Mobile communications devices distract the driver from the traffic situation. This could also cause the driver to lose control of the vehicle.



- ▶ As the driver, only operate mobile communications devices when the vehicle is stationary.
- ▶ As a vehicle occupant, only use mobile communications devices in the areas intended for this purpose, e.g. in the rear passenger compartment.

You must observe the legal requirements for the country in which you are currently driving when operating mobile communication equipment in the vehicle.

Further information can be obtained from an authorized Mercedes-Benz Center or at: <http://www.mercedes-benz.com/connect>.

Telephone menu overview



- ① Bluetooth® device name of the currently connected mobile phone
- ② Signal strength of the mobile phone network for the currently connected and selected mobile phone
- ③ Battery status of the currently connected and selected mobile phone
- ④  (telephone ready) or  (call active)

- ⑤ [Contacts](#) (→ page 252)
- ⑥ [Recent Calls](#) (→ page 254)
- ⑦ [Text Message](#)
- ⑧ One mobile phone connected: [Active Call](#).
Two mobile phones connected: changes view between telephone 1 and 2 or [Active Call](#)
- ⑨ [Devices](#) (→ page 248)

- ⑩ [Options](#)
Symbols ① to ④ are not shown until after a mobile phone has been connected to the multimedia system. The symbols depend on your mobile phone and your mobile phone network provider.

Bluetooth® profile overview

Bluetooth® profile of the mobile phone	Function
PBAP (Phone Book Access Profile)	Contacts are automatically displayed in the multimedia system
MAP (Message Access Profile)	Message functions can be used

Telephony operating modes overview

Depending on your equipment, the following telephony operating modes are available:

- A mobile phone is connected to the multimedia system via Bluetooth® (→ page 248).
- Two mobile phones are connected with the multimedia system via Bluetooth® (two phone mode) (→ page 249).

Information on telephony

The following situations can lead to the call being disconnected while the vehicle is in motion:

- There is insufficient network coverage in the area
- You move from one GSM or UMTS transmitter/receiver area (cell) into another and no communication channels are free
- The SIM card used is not compatible with the network available
- A mobile phone with "Twincard" is logged into the network with the second SIM card at the same time

The multimedia system supports calls in HD Voice® for improved speech quality. A requirement for this is that the mobile phone and the mobile phone network provider of the person you are calling support HD Voice®.

Depending on the quality of the connection, the voice quality may fluctuate.

Connecting a mobile phone (Bluetooth® telephony)**Requirements:**

- Bluetooth® is activated on the mobile phone (see the manufacturer's operating instructions).
- Bluetooth® is activated on the multimedia system (→ page 208).

Multimedia system:

➔ Phone ➔ ⌘ Devices

Searching for a mobile phone

- ▶ Select **Connect New Device**.
- ▶ Select **Start Search on System**.
The available mobile phones are displayed. If a new mobile phone is found, it is indicated by the  symbol.

Connecting a mobile phone (authorization using Secure Simple Pairing)

- ▶ Select the mobile phone.
A code is displayed in the multimedia system and on the mobile phone.

- ▶ **If the codes match:** confirm the code on the mobile phone.

Connecting a mobile phone (authorization by entering a passkey)

- ▶ Select the mobile phone.
- ▶ Choose a one to sixteen-digit number combination as a passkey.
- ▶ **On the multimedia system:** enter the passkey and select .
- ▶ **On the mobile phone:** enter the passkey again and confirm.

- ⓘ Up to 15 mobile phones can be authorized on the multimedia system. Authorized mobile phones are reconnected automatically.

Connecting a second mobile phone (two phone mode)

Requirements:

- At least one mobile phone is already connected to the multimedia system via Bluetooth®.

Multimedia system:

↳ Phone ▶▶ Bluetooth Devices

- ▶ Select **Connect New Device**.
- ▶ Select **Start Search on System**. The available mobile phones are displayed.
- ▶ Select the mobile phone.
- ▶ Answer the **How would you like to connect the new device?** prompt.
- ▶ **To replace the currently connected mobile phone:** select **Phone 1**. The currently connected mobile phone is replaced by the new mobile phone.

or

- ▶ **To connect the second mobile phone:** select **Phone 2**. The new mobile phone is connected as **Phone 2**. If two mobile phones have already been connected, the second telephone is replaced by the new mobile phone.

or

- ▶ **To use the mobile phone as an audio source:** select **Audio Source** (→ page 282).

- ⓘ A mobile phone can be operated both as an audio source as well as telephone in parallel.
- ⓘ It is possible at any future point to change the type of connection for the mobile phone already connected and to set this as **Phone 1**, **Phone 2** or **Audio Source** (→ page 249).

Functions of the mobile phone in two phone mode

Functions overview

Mobile phone in the foreground	Mobile phone in the background
Full range of functions	Incoming calls

Interchanging mobile phones (two phone mode)

Requirements:

- The mobile phones are authorized (→ page 248).

Multimedia system:

→ Phone → Bluetooth Devices

- ▶ In the device overview, select a mobile phone which has already been authorized and set as **Phone 1** or **Phone 2**.

After interchanging the mobile phones, the mobile phone in the foreground is replaced by the mobile phone in the background.

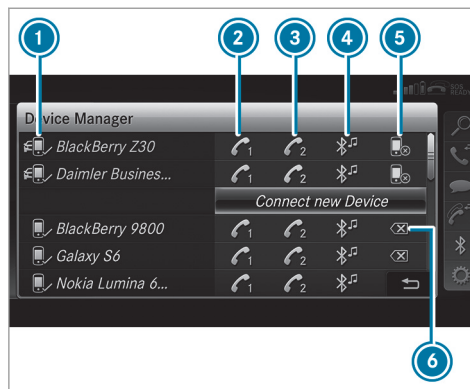

- 1 Bluetooth® device name of the currently connected mobile phone
- 2 Connects a mobile phone as **Phone 1**
- 3 Connects a mobile phone as **Phone 2**
- 4 Connects a mobile phone as **Audio Source**
- 5 Disconnecting a mobile phone(→ page 250)
- 6 De-authorizing a mobile phone(→ page 250)

- ⓘ If a new mobile phone is connected and defined as **Phone 1**, for example, this overwrites the previously connected mobile phone in the foreground of the system.

Disconnecting a mobile phone

Multimedia system:

→ Phone → Bluetooth Devices

- ▶ Select the  symbol in the line of the mobile phone.
The disconnection of the mobile phone takes place without a confirmation prompt. The mobile phone remains authorized in the system.

De-authorizing a mobile phone

Multimedia system:

→ Phone → Bluetooth Devices

- ▶ Select the  symbol in the line of the mobile phone.
- ▶ Answer the confirmation prompt with **Yes**.
The mobile phone is de-authorized and deleted from the system.

Setting the reception and transmission volume

Requirements:

- A mobile phone is authorized (→ page 248).

Multimedia system:

↳ Phone ▶  Options ▶ Phone

This function ensures optimal language quality.

- ▶ Select [Reception Volume](#) or [Transmission Volume](#).
- ▶ Set the volume.

Further information on the recommended reception and transmission volume: <http://www.mercedes-benz.com/connect>

Adjusting the call and ringtone volume

Multimedia system:

↳ System ▶  Audio ▶ Phone

- ▶ Select [Call Volume](#) or [Ringtone Volume](#).
- ▶ Set the volume.

Starting/stopping mobile phone voice recognition

Requirements:

- The mobile phone is connected to the multimedia system (→ page 248).

Starting mobile phone voice recognition

- ▶ Press and hold the  button on the multi-function steering wheel for more than one second.
You can use mobile phone voice recognition.

Stopping mobile phone voice recognition

- ▶ Press the  or  button on the multi-function steering wheel.

Calls

Using the telephone

Multimedia system:

↳ Phone ▶  Contacts

Making a call

- ▶ Select [Numerical Keypad](#).
- ▶ Enter the number.
- ▶ Select .
The call is made.

Accepting a call

- ▶ Select [Accept](#).

Rejecting a call

- ▶ Select [Reject](#).

Ending a call

- ▶ Select .

Activating functions during a call

- ▶ To show all functions, navigate down.

The following functions are available during a call:

- [End Call](#)
- [Make Additional Call](#)
- [Keyboard](#) (show to send DTMF tones)
- Switch [Mute Mic](#) on or off .
- [Private Mode](#) (an active call in hands-free mode is transferred over to the telephone)

Conducting calls with several participants

Requirements:

- There is an active call (→ page 251).
- Another call is being made.

Switching between calls

- ▶ Select call ●.
The selected call is active. The other call is on hold.

Activating or ending a call on hold

- ▶ Select [Continue Call](#) or [End Call](#).

Conducting a conference call

- ▶ Select [Create Conference Call](#) in the telephone menu.
The new participant is included in the conference call.

Ending an active call

- ▶ Select .

- ⓘ On some mobile phones, the call on hold is activated as soon as the active call is ended.

Accepting/rejecting a waiting call Requirements:

- There is an active call (→ page 251).

If you receive a call while already in a call, a message is displayed. An acoustic signal also sounds.

- ▶ Select [Accept](#).
The incoming call is active.

If only one mobile phone is connected with the multimedia system, the previous call will be put on hold.

If during a call you accept a call with the other mobile phone when in two phone mode then the existing call is ended.

- ▶ Select [Reject](#).

- ⓘ This function and behavior depends on your mobile phone network provider and the mobile phone (see the manufacturer's operating instructions).

Contacts

Information about the contacts menu

The contacts menu contains all contacts from existing data sources, e.g. mobile phone or memory card. You can store up to 6,000 contacts.

Depending on the data source, you have the following number of contacts:

- Permanently saved contacts: 3,000 entries

- Contacts loaded from the mobile phone: 3,000 entries

From the contacts menu, you can perform the following actions:

- Using the telephone:
 - Calling a contact (→ page 254)
 - Calling a new number (→ page 251)
- Navigation (→ page 226)
- Compose messages (→ page 255)

If a mobile phone is connected to the multimedia system (→ page 248) and automatic calling up (→ page 252) is activated, the mobile phone's contacts are displayed in the address book.

Downloading mobile phone contacts

Multimedia system:

↳ Phone ▶  Options ▶ Contacts

Automatically

- ▶ Switch [Synchronize Contacts Automatically](#) on .

Manually

- ▶ Deactivate [Synchronize Contacts Automatically](#).
- ▶ Select [Synchronize Contacts](#).

Calling up contacts

Multimedia system:

↳ [Phone](#) ▶ [Contacts](#)

Depending on the character set, the following options can be used to search for contacts:

- searching by initials
 - searching by name
 - searching by phone number
- ▶ Enter characters into the search field. A selection of possible contacts appears. Entering more characters into the search field narrows down the number of possible selections.
- ▶ Select the contact.

A contact can contain the following details:

- phone numbers
- navigation addresses

- geo-coordinates
- Internet address

Editing the format of a contact's name

Multimedia system:

↳ [Phone](#) ▶ [Options](#) ▶ [Contacts](#)
▶ [Name Format](#)



The following options are available:



- [Last Name, First Name](#)
- [Last Name First Name](#)
- [First Name Last Name](#)

▶ Select an option.

Overview of importing contacts

Contacts from various sources

Source	Requirements
 Memory card	The SD memory card is inserted.
 USB device	The USB device is inserted in the USB port.

Source	Requirements
 Bluetooth® connection	If the sending of vCards via Bluetooth® is supported, vCards can be received on mobile phones or notebooks, for example. Bluetooth® is activated in the multimedia system and on the respective device (see the manufacturer's operating instructions).
 Mobile phone	The mobile phone is connected to the multimedia system.

Importing contacts into the contacts menu

Multimedia system:



↳ [Phone](#) ▶ [Options](#) ▶ [Contacts](#)

- ▶ Select [Import](#).
- ▶ Select an option.

Saving a mobile phone contact

Multimedia system:

→ Phone →  Contacts

- ▶ Select the mobile phone contact .
- ▶ Select .
- ▶ Select **Save to Vehicle**.
The contact saved in the multimedia system is identified by the  symbol.

Calling a contact

Multimedia system:

→ Phone →  Contacts

- ▶ Enter characters into the search field.
- ▶ Select the contact.
- ▶ Select the telephone number.
The number is dialed.

Selecting further options in the contacts menu

Multimedia system:

→ Phone →  Contacts

- ▶ Select a contact.
- ▶ Select .

Depending on the stored data, the following options are available:

- **Call**
 - **Send Text Message**
 - **Show Website** (if an Internet address has been stored)
 - **Navigate** (if an address has been stored)
 - **Save My Favorite**
 - **Send DTMF Tones** (for a number with DTMF tones)
- ▶ Select an option.

Deleting a contact

Multimedia system:

→ Phone →  Contacts

You can delete contacts stored in the vehicle.

- ▶ Search for the contact.
- ▶ Select the contact.
- ▶ Select .
- ▶ Select **Delete Contact**.
- ▶ Select **Yes**.

Call list**Call list overview**

Depending on whether your mobile phone supports the PBAP Bluetooth® profile or not, this can have different effects on the presentation and functions of the call list.

If the PBAP Bluetooth® profile is supported, the effects are as follows:

- The call lists from the mobile phone are displayed in the multimedia system.
- When connecting the mobile phone, you may have to confirm the connection for the PBAP Bluetooth® profile.

If the PBAP Bluetooth® profile is not supported, the effects are as follows:

- The multimedia system generates its own call lists.
- The call list is not synchronized with the call lists in the mobile phone.

Making a call from the call list

Multimedia system:

☞ Phone >> 📞 Recent Calls

- ▶ Select a number.
The call is made.

Text messages

Overview of text message functions

If the connected mobile phone supports the MAP Bluetooth® profile, the text message functions can be used on the multimedia system.

You can obtain further information about settings and supported functions of Bluetooth®-capable mobile phones from an authorized Mercedes-Benz Center or at: <http://www.mercedes-benz.com/connect>

Some mobile phones require further settings after being connected to the multimedia system (see manufacturer's operating instructions).

New messages are identified by the 📧 symbol in the media display and an audible signal.

Depending on the mobile phone, the multimedia system only displays new incoming text messages or the 100 newest text messages.

Configuring the text messages displayed

Multimedia system:

☞ Phone >> ⚙️ Options >> Text Message

>> Message Display

- ▶ Select [📧].

A menu with the following options is shown:

- All Messages
- New and Unread Messages
- New Messages
- Off (The text messages are not displayed automatically.)

- ▶ Select an option.

- ⓘ The setting may not be active until the mobile phone is reconnected.

Reading text messages

Multimedia system:

☞ Phone >> 📧 Text Message

Reading a text message

- ▶ Select a text message.
The message text is displayed.

Using the read-aloud function

- ▶ Select a text message.
- ▶ Select **Read Aloud**.
The text message is read aloud.

Composing and sending a text message

Multimedia system:

☞ Phone >> 📧 Text Message

- ▶ Select **Write New Text Message**.

Adding a recipient

- ▶ Select **Press to Add Recipient**.
- ▶ Select the contact.

Dictating text

- ▶ Select **Press to Dictate**.

- ▶ **To start the dictation function:** press on the central control element.
The app for the dictation function is loaded.

If there was no prior Internet connection, a connection is now established.

- ▶ Say the message.
The dictation ends automatically after you have finished speaking.
After the voice message has been processed, it is shown as text.

- ▶ **To replace a message:** select [Replace message](#).
The text that has been dictated and shown on the display is reset and can be dictated again.

Editing text

- ▶ Select the word.
- ▶ **To call up the correction menu:** press on the central control element.
The following options are available:
 - Adjusting the capitalization of words (if supported by the character set)

- Expanding the choice of words
- Deleting the selection
- Recording a new dictation

- ▶ **To leave the menu:** select [Done](#).

Sending text messages

- ▶ Select [Send Text Message](#).

Replying to a text message

Multimedia system:

- ▶ [Phone](#) ▶ [Text Message](#)

- ▶ Open the text message.
- ▶ Select [Text Message](#).
- ▶ Select [Reply](#).

Calling a text message sender

Multimedia system:

- ▶ [Phone](#) ▶ [Text Message](#)

- ▶ Open the text message.
- ▶ Select [Text Message](#).
- ▶ Select [Call Sender](#).

Deleting text messages

Multimedia system:

- ▶ [Phone](#) ▶ [Text Message](#)

- ▶ Select [Text Message](#).

- ▶ **To delete a text message:** select [Delete](#).
[Outbox](#)

or

- ▶ Select [Drafts](#).

Mercedes-Benz link

Overview of Mercedes-Benz Link

⚠ WARNING Risk of distraction from information systems and communications equipment

If you operate information and communication equipment integrated in the vehicle when driving, you will be distracted from the traffic situation. This could also cause you to lose control of the vehicle.

- ▶ Only operate this equipment when the traffic situation permits.

- ▶ If you cannot be sure of this, stop the vehicle whilst paying attention to road and traffic conditions and operate the equipment with the vehicle stationary.

Using Mercedes-Benz Link, various functions and selected mobile phone apps can be transferred to the media display.

The Mercedes-Benz Link control box supplementary equipment is required for this. You can obtain this at an authorized Mercedes-Benz Center.

- ⓘ The Mercedes-Benz Link control box uses the Android operating system.
- ⓘ The service provider is responsible for these apps and the services and content connected to it.

Connecting Mercedes-Benz Link with the multimedia system

- ▶ Connect the Mercedes-Benz Link control box with the  USB port of the multimedia connection unit using a suitable connecting cable.

- ⓘ A suitable connecting cable is available separately at an authorized Mercedes-Benz Center.

Using Mercedes-Benz Link Requirements:

- The Mercedes-Benz Link control box is connected with the multimedia system using the  USB port.

Multimedia system:

↳ [Connect](#)

- ▶ Select [Mercedes-Benz Link](#).

- ▶ Select [MB Link](#).

The mobile phone functions and apps are available and shown on the media display.

You can find more information in the Mercedes-Benz Link control box operating instructions.

Ending Mercedes-Benz Link

Multimedia system:

↳ [Connect](#) ▶ [Mercedes-Benz Link](#)

- ▶ Select [Disconnect](#).

The connection is ended.

The mobile phone continues to be supplied with electricity.

or

- ▶ Disconnect the connecting cable between the Mercedes-Benz Link control box and the multimedia system.

- ⓘ Mercedes-Benz recommends disconnecting the connecting cable only when the vehicle is stationary.

Apple CarPlay®

Overview of Apple CarPlay®

⚠ WARNING Risk of distraction from information systems and communications equipment

If you operate information and communication equipment integrated in the vehicle when driving, you will be distracted from the traffic situation. This could also cause you to lose control of the vehicle.

- ▶ Only operate this equipment when the traffic situation permits.
- ▶ If you cannot be sure of this, stop the vehicle whilst paying attention to road and traffic conditions and operate the equipment with the vehicle stationary.

You must observe the legal requirements for the country in which you are currently driving when operating the multimedia system.

iPhone® functions can be used via the multimedia system using Apple CarPlay®. They are operated using the central control element or the Siri® voice-operated control system. You can activate the voice-operated control system by pressing and holding the  button on the multifunction steering wheel.

When using Apple CarPlay® via the voice-operated control system, the multimedia system can still be operated via the Voice Control System (→ page 184).

Only one mobile phone at a time can be connected via Apple CarPlay® to the multimedia system.

The availability of Apple CarPlay® may vary according to the country.

The service provider is responsible for this application and the services and content connected to it.

Apple CarPlay® is a registered trademark of Apple Inc.

Information on Apple CarPlay®

While using Apple CarPlay® various functions of the multimedia system, e.g. telephony or the media sources Bluetooth® audio and iPod®, are unavailable.

Only one route guidance can be active at a time. If route guidance is active on the multimedia system, it is closed when route guidance is started on the mobile phone.

Connecting an iPhone® via Apple CarPlay® Requirements:

- Apple® operating system version iOS 8.3 or above is installed on the iPhone®.
- An Internet connection is required for the full range of functions for Apple CarPlay®.

- The iPhone® is connected to the multimedia system via the USB port  using a suitable cable (→ page 276).

Multimedia system:

➔ [Connect](#) ➔ [Apple CarPlay](#)

Setting automatic or manual start

A message appears when connected for the first time.

- ▶ **Automatic start:** select [Automatically](#). [Start Automatically](#) is activated .

Apple CarPlay® will now start immediately after the iPhone® is connected to the multimedia system using a USB cable.

- ▶ **Manual start:** select [Manually](#).
- ▶ Select the iPhone® in the device list.

Accepting/rejecting the data protection regulations

A message with the data protection regulations appears.

- ▶ Select [Accept & Start](#).
- or

- ▶ Select **Decline & End**.

Exiting Apple CarPlay®

- ▶ Press the  button on the multifunction steering wheel, for example.

- ⓘ If Apple CarPlay® was not displayed in the foreground before disconnecting, the application starts in the background when reconnected. You can call up Apple CarPlay® in the main menu.

Calling up Apple CarPlay® sound settings

Multimedia system:

↳ **Connect** ▶▶ **Apple CarPlay** ▶▶ **Sound**

- ▶ Select the sound menu (→ page 292).

Ending Apple CarPlay®

Multimedia system:

↳ **Connect** ▶▶ **Apple CarPlay**

- ▶ Select **Disconnect**.
The connection is ended.
The mobile phone continues to be supplied with electricity.

or

- ▶ Disconnect the connecting cable between the mobile phone and multimedia system. Mercedes-Benz recommends disconnecting the connecting cable only when the vehicle is stationary.

Android Auto

Android Auto overview

⚠ WARNING Risk of distraction from information systems and communications equipment

If you operate information and communication equipment integrated in the vehicle when driving, you will be distracted from the traffic situation. This could also cause you to lose control of the vehicle.

- ▶ Only operate this equipment when the traffic situation permits.
- ▶ If you cannot be sure of this, stop the vehicle whilst paying attention to road and traffic conditions and operate the equipment with the vehicle stationary.

You must observe the legal requirements for the country in which you are currently driving when operating the multimedia system.

Mobile phone functions can be used with Android Auto using the Android operating system on the multimedia system. It is operated using the central control element or the voice control. You can activate the voice-operated control system by pressing and holding the  button on the multifunction steering wheel.

When using Android Auto via the voice-operated control system, the multimedia system can still be operated via the Voice Control System (→ page 184).

Only one mobile phone at a time can be connected via Android Auto to the multimedia system.

The availability of Android Auto and Android Auto Apps may vary according to the country.

The service provider is responsible for this application and the services and content connected to it.

Information on Android Auto

While using Android Auto, various functions of the multimedia system, for example the media source Bluetooth® audio, are not available.

Only one route guidance can be active at a time. If route guidance is active on the multimedia system, it is closed when route guidance is started on the mobile phone.

Connecting a mobile phone via Android Auto Requirements:

- The first activation of Android Auto on the multimedia system must be carried out when the vehicle is stationary for safety reasons.
- The mobile phone supports Android Auto from Android 5.0.
- The Android Auto app is installed on the mobile phone.
- In order to use the telephone functions, the mobile phone must be connected to the multimedia system via Bluetooth® (→ page 248).

If there was no prior Internet connection, this is established with the use of the mobile phone with Android Auto.

- The mobile phone is connected to the multimedia system via the USB port  using a suitable cable (→ page 276).
- An Internet connection is required for the full range of functions for Android Auto.

Multimedia system:

 [Connect](#)  [Android Auto](#)

-  Select the mobile phone from the device list.

Accepting/rejecting the data protection regulations

A message with the data protection regulations appears.

-  Select [Accept & Start](#).

or

-  Select [Decline & End](#).



Activating automatic start

-  Select [Start Automatically](#) .

Starting manually

-  Select the mobile phone from the device list.

Exiting Android Auto

-  Press the  button on the multifunction steering wheel, for example.
-  If Android Auto was not displayed in the foreground before disconnecting, the application starts in the background when reconnected. You can call up Android Auto in the main menu.

Calling up the Android Auto sound settings

Multimedia system:

 [Connect](#)  [Android Auto](#)  [Sound](#)

-  Select the tone menu (→ page 292).

Ending Android Auto

Multimedia system:

 [Connect](#)  [Android Auto](#)

-  Select [Disconnect](#).
The connection is ended.
The mobile phone continues to be supplied with electricity.

or

- ▶ Disconnect the connecting cable between the mobile phone and multimedia system. Mercedes-Benz recommends disconnecting the connecting cable only when the vehicle is stationary.

Transferred vehicle data with Android Auto and Apple CarPlay®

Overview of transferred vehicle data

When using Android Auto or Apple CarPlay®, certain vehicle data is transferred to the mobile phone. This enables you to get the best out of selected mobile phone services. Vehicle data is not directly accessible.

The following system information is transmitted:

- Software release of the multimedia system
- System ID (anonymized)

The transfer of this data is used to optimize communication between the vehicle and the mobile phone.

To do this, and to assign several vehicles to the mobile phone, a vehicle identifier is randomly generated.

This has no connection to the vehicle identification number (VIN) and is deleted when the multimedia system is reset (→ page 216).

The following driving status data is transmitted:

- Transmission position engaged
- Distinction between parked, standstill, rolling and driving
- Day/night mode of the instrument cluster

The transfer of this data is used to alter how content is displayed to correspond to the driving situation.

The following position data is transmitted:

- Coordinates
- Speed
- Compass direction
- Acceleration direction

This data is only transferred while the navigation system is active in order to improve it (e.g. so it can continue functioning when in a tunnel).

Mercedes me calls

Making a call via the overhead control panel Requirements:

- You have access to a GSM network.
- The contract partner's GSM network coverage is available in the respective region.
- The ignition is switched on so that vehicle data can be transferred automatically.

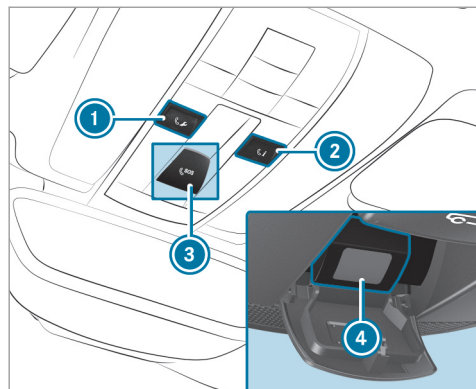

- ▶ **To make a breakdown assistance call:** press button ①.
- ▶ **To make an emergency call:** press SOS button cover ③ briefly to open.
- ▶ Press and hold SOS button ④ for at least one second.
- ▶ **To make an MB Info call:** press button ②.

An emergency call can be initiated even if a breakdown assistance or MB Info call is active. This has priority over all other active calls.

Calls via the overhead control panel are only possible with an available mobile phone network.

More information on Mercedes me connect and further services can be found at: <http://www.mercedes.me>

Calling the Mercedes-Benz Customer Center using the multimedia system

Requirements:

- You have access to a GSM network.
- The contract partner's GSM network coverage is available in the respective region.
- The ignition is switched on so that vehicle data can be transferred automatically.

Multimedia system:

➔ Phone ➔ Contacts

- ▶ Call [Mercedes me connect](#).
The call is made.

Then, you can select a service and be connected to a specialist at the Mercedes-Benz Customer Center.

Information on the MB Info call

An Info call to the Mercedes-Benz Customer Center has been initiated via the overhead control panel or the multimedia system.

You can find information on the following topics:

- Activation of Mercedes me connect
- Operating the vehicle
- Nearest authorized Mercedes-Benz Center
- Other products and services from Mercedes-Benz

Data is transferred during the connection to the Mercedes-Benz Customer Center.

Information on the breakdown assistance call

A breakdown assistance call to the Mercedes-Benz Customer Center has been initiated via the overhead control panel (→ page 261) or the multimedia system (→ page 262).

For the scope of accident and breakdown management, see "Information on Mercedes me connect accident and breakdown management" (→ page 264).

Data is transferred during the connection to the Mercedes-Benz Customer Center (→ page 263).

Arranging a service appointment via a Mercedes me call

If you have activated the maintenance management service, relevant vehicle data is transferred automatically to the Mercedes-Benz Customer Center. You will then receive individual recommendations regarding the maintenance of your vehicle.

Regardless of whether you have consented to the maintenance management service, the multimedia system reminds you after a certain amount of time that a service is due. A prompt appears asking if you would like to make an appointment.

▶ **To arrange a service appointment:** select **Call**.

After your agreement the vehicle data is sent and a Mercedes-Benz Customer Center

employee deals with your appointment. The information is then sent to your desired service outlet.

This will contact you to confirm the appointment and if necessary consult about the details.

ⓘ If you select **Later** after the service message appears, the message is hidden and reappears at a later time.

Transferred data during a Mercedes me call

The data transferred during a Mercedes me call depends on which service is selected in the voice control system and whether Mercedes me connect services are activated.

If no Mercedes me connect services are activated and the data protection prompt has been confirmed the following data is transmitted:

- Vehicle identification number
- Mercedes me customer identification number
- Reason for the initiation of the call
- Language set in the multimedia system
- Confirmation of the data protection prompt

If a call is made for a service appointment via the service reminder, the following data may be transmitted:

- Current mileage and maintenance data
- Transfer is possible assuming the required data transfer technology is supported by the mobile service operator and the quality of the mobile connection is sufficient.

If accident and breakdown management is called via the voice control system and no service has been activated, but the data protection query has been confirmed, the following data can also be called up from the vehicle by the Mercedes-Benz Customer Center:

- Current location of the vehicle
- ⓘ At the time of going to press, this function is technically not yet available but can be supported in the future.

If the data protection prompt has been rejected the following data is transmitted:

- Reason for the initiation of the call
- Rejection of the data protection prompt

Mercedes me connect

Notes on Mercedes me connect

Mercedes me connect consists of multiple services.

Depending on whether the services are activated and on the vehicle equipment, you can use the following services via the multimedia system and the overhead control panel, for example:

- Accident and breakdown management (breakdown assistance call button)
- If the service is activated: Concierge Service (Info call button)
- Mercedes-Benz emergency call system (automatic emergency call or SOS button in the overhead control panel)

The Mercedes-Benz Customer Center and the Mercedes-Benz emergency call center are available for you around the clock.

The Info call button, the breakdown assistance call button and the emergency call button can be found on the overhead control panel of the vehicle (→ page 261).

You can call the Mercedes-Benz Customer Center using the multimedia system (→ page 262).

Please note that Mercedes me connect is a Mercedes-Benz service. In emergencies, always call the national emergency services first using the standard national emergency service phone numbers. In emergencies, you can also use the Mercedes-Benz emergency call system (→ page 265).

Information on Mercedes me connect accident and breakdown management

The accident and breakdown management can include the following functions:

- Supplement to the Mercedes-Benz emergency call system (→ page 265)
If necessary, the contact person at the Mercedes-Benz emergency call center forwards the call to Mercedes me connect breakdown and accident management. Forwarding the call is however not possible in all countries.
- Breakdown assistance by a mechanic on location and/or the towing away of the vehi-

cle to the nearest authorized Mercedes-Benz Center

You may be charged for these services.

More information about Mercedes me connect services can be obtained in the Mercedes me portal: <https://me.secure.mercedes-benz.com>

Data transferred during Mercedes me connect call services

The data transferred during a Mercedes me call depends on which service is selected in the voice control system and which Mercedes me connect services are activated.

Which data is transferred for the services, can be taken from the currently valid terms of use. These can be obtained in the Mercedes me portal: <https://me.secure.mercedes-benz.com>

Mercedes-Benz emergency call system

Information on the Mercedes-Benz emergency call system

Your vehicle is equipped with the Mercedes-Benz emergency call system ("eCall"). This feature can help save lives in the event of an accident. eCall

in no way replaces assistance provided from dialing 911.

The Mercedes-Benz emergency call system is available for at least ten years starting from the manufacturing date.

Mercedes-Benz eCall only functions in areas where mobile phone coverage is available from the wireless service providers. Insufficient network coverage from the wireless service providers may result in an emergency call not being transmitted.

eCall is a standard feature in your Mercedes-Benz vehicle. In order to function as intended, the system relies on the transmission of data detailed in the "Mercedes-Benz emergency call system data transmission" section that follows (→ page 267).

To disable eCall, a customer must visit an authorized Mercedes-Benz Service department to deactivate the vehicle's communication module.

Deactivation of this module prevents the activation of any and all Mercedes me connect services. After the deactivation of

eCall, automatic emergency call and manual emergency call will not be available.

The ignition must be switched on before an automatic emergency call can be made.

- ① eCall is activated at the factory.
- ① eCall can be deactivated by an authorized Mercedes-Benz dealer. Please note that in the event ownership of the vehicle is transferred to another owner in its deactivated state, eCall will remain deactivated unless the new owner visits an authorized Mercedes-Benz dealership to reactivate the system.

Overview of the Mercedes-Benz emergency call system

eCall can help to reduce the time between an accident and the arrival of emergency services at the site of the accident. It helps locate an accident site in places that are difficult to access. However, even if a vehicle is equipped with eCall, this does not mean the system is ON. As such, eCall does not replace dialing 911 in the event of an accident.

The emergency call can be made automatically (→ page 266) or manually (→ page 266). Only make emergency calls if you or others are in need of rescue.

Only make emergency calls if you or others are in need of rescue. Do not make an emergency call in the event of a breakdown or a similar situation.

Displays in the media display:

SOS READY: eCall available

SOS NOT READY: the ignition is not on or eCall is not available.

During an active emergency call,  appears in the display.

You can find more information on the regional availability of eCall system at: http://www.mercedes-benz.com/connect_ecall.

- ① If there is a malfunction in the emergency call system (e.g. a malfunction with the speaker, microphone, airbag, SOS button), a corresponding message appears in the multifunction display of the instrument cluster.

Triggering an automatic emergency call Requirements

- The ignition is switched on.
- The starter battery is sufficiently charged.

If restraint systems such as airbags or Emergency Tensioning Devices have been activated after an accident, the Mercedes-Benz emergency call system may automatically initiate an emergency call.

The emergency call has been made:

- A voice connection is made to the Mercedes-Benz emergency call center.
- A message with accident data is transmitted to the Mercedes-Benz emergency call center. The Mercedes-Benz emergency call center can transmit the vehicle position data to one of the emergency call centers.

The SOS button in the overhead control panel flashes until the emergency call is finished.

It is not possible to immediately end an automatic emergency call.

If no connection can be made to the emergency services either, a corresponding message appears in the media display.

▶ Dial the local emergency number on your mobile phone.

If an emergency call has been initiated:

- Remain in the vehicle if the road and traffic conditions permit you to do so until a voice connection is established with the emergency call center operator.
- Based on the call, the operator decides whether it is necessary to call rescue teams and/or the police to the accident site.
- If no vehicle occupant answers, an ambulance is sent to the vehicle immediately.

Triggering a manual emergency call

▶ Press and hold the SOS button in the overhead control panel for at least one second.

The emergency call has been made:

- A voice connection is made to the Mercedes-Benz emergency call center.

- A message with accident data is transmitted to the Mercedes-Benz emergency call center. The Mercedes-Benz emergency call center can transmit the vehicle position data to one of the emergency call centers.

- Remain in the vehicle if the road and traffic conditions permit you to do so until a voice connection is established with the emergency call center service provider.
- On the basis of the call, the service provider decides whether it is necessary to call rescue teams and/or the police to the accident site.

If no connection can be made to the emergency services either, a corresponding message appears in the media display.

▶ Dial the local emergency number on your mobile phone.

Ending an unintentional emergency call

▶ **Select**  on the multifunction steering wheel. Depress button for several seconds.

Data transfer of the Mercedes-Benz emergency call system

In the event of an automatic or manual emergency call the following data is transmitted, for example:

- Vehicle's GPS position data
- GPS position data on the route (a few hundred meters) before the incident
- Direction of travel
- Vehicle identification number
- Vehicle drive type
- Number of people determined to be in the vehicle
- Whether Mercedes me connect is available or not
- Whether the emergency call was initiated manually or automatically
- Time of the accident
- Language setting on the multimedia system

Data transmitted is vehicle information. For any questions about the collection, use and sharing of the eCall system data, please contact MBU-

SA's Customer Assistance Center at 800-FOR-MERC.

For Canada, please contact MBC's Customer Assistance Center at 1-800-387-0100.

Customer requests for covered information should be submitted via the same channels.

For accident clarification purposes, the following measures can be taken up to an hour after the emergency call has been initiated:

- The current vehicle position can be called up.
- A voice connection to the vehicle occupants can be established

Online and Internet functions

Internet connection

Information on connecting to the Internet

⚠ WARNING Risk of distraction from information systems and communications equipment

If you operate information and communication equipment integrated in the vehicle when driving, you will be distracted from the traffic situation. This could also cause you to lose control of the vehicle.

- ▶ Only operate this equipment when the traffic situation permits.
- ▶ If you cannot be sure of this, stop the vehicle whilst paying attention to road and traffic conditions and operate the equipment with the vehicle stationary.

You must observe the legal requirements for the country in which you are currently driving when operating the multimedia system.

▲ WARNING Risk of an accident from operating mobile communication equipment while the vehicle is in motion

Mobile communications devices distract the driver from the traffic situation. This could also cause the driver to lose control of the vehicle.

- ▶ As the driver, only operate mobile communications devices when the vehicle is stationary.
- ▶ As a vehicle occupant, only use mobile communications devices in the areas intended for this purpose, e.g. in the rear passenger compartment.

You must observe the legal requirements for the country in which you are currently driving when operating mobile communication equipment in the vehicle.

The Internet functions can only be used to a limited degree whilst driving.

Function of the communication module

On vehicles with a built-in communication module, the Internet connection is established via an integrated SIM card.

To use Internet access via the communication module the following conditions must be met:

- The vehicle is equipped with a permanently installed communication module.
- Mercedes me connect is active and ready for operation.
- Mercedes me connect is activated for Internet access.
- Country dependent: data volume via Mercedes me connect is available.

If the data volume limit is reached, the availability of Mercedes me connect services is limited. The data volume must be purchased via Mercedes me connect.

- ① Contact an authorized Mercedes-Benz Center to find out whether it is possible to purchase data volume in your country.

Establishing an Internet connection

Multimedia system:

 [Connect](#)

▶ For example, select  [Browser](#).

- ① The multimedia system usually establishes the Internet connection automatically. If the multimedia system is not connected to the Internet, the Internet connection is established when an Internet application is used.
- ① The availability of web browsers is country-dependent.

Connection status

Connection status overview



- ① Display of the communication module reception field strength
- ② Display of existing connection

Displaying the connection status

Multimedia system:

↳ System ▶️ 📶 Connectivity

▶️ Select **Internet Status**.

① In the case of a connection via the communication module the following status information is shown:

- Type of network
- Status online/offline

Mercedes-Benz Apps

Calling up Mercedes-Benz Apps

Requirements:

- The registration for the use of Mercedes-Benz Apps has been completed.
- The general terms and conditions have been confirmed.

Multimedia system:

↳ Connect ▶️ 📶 Mercedes-Benz Apps

▶️ Select an app.

- ① The available features are country-dependent.
License fees may be applicable.

Operating Mercedes-Benz Apps using voice control

Requirements:

- The registration for the use of Mercedes-Benz Apps has been completed.
- The general terms and conditions have been confirmed.

The 🗣️ symbol indicates that a Mercedes-Benz app can be used via voice control.

▶️ Select a Mercedes-Benz app.
The app menu is displayed.

▶️ **To use voice control:** select 🗣️ **Language**.

▶️ Say the question or command.

- ① Voice control is not available in all countries and languages.

Web browser

Calling up a web page

⚠ WARNING Risk of distraction from information systems and communications equipment

If you operate information and communication equipment integrated in the vehicle when driving, you will be distracted from the traffic situation. This could also cause you to lose control of the vehicle.

- ▶ Only operate this equipment when the traffic situation permits.
- ▶ If you cannot be sure of this, stop the vehicle whilst paying attention to road and traffic conditions and operate the equipment with the vehicle stationary.

You must observe the legal requirements for the country in which you are currently driving when operating the multimedia system.

Multimedia system:

➔ Connect ➔  Browser
 ➔  Enter URL

▶ Enter a web address.

i The function is country-dependent.

▶ **To finish the entry and call up the website:** select  .

Showing/hiding the web browser menu

If you call up a website by selecting a link, for example, the web browser menu is hidden.

▶ **To show/hide:** press the  button.

i The web browser supports video playback.

i No websites or videos are displayed while the vehicle is in motion.

Web browser overview



- ① URL entry
- ② Bookmarks
- ③ Web page, back
- ④ Web page, forwards
- ⑤ Options
- ⑥ Closes the browser

Calling up web browser options

Multimedia system:

 Connect >>  Browser
 >>  Options

The following functions are available:

- Refresh Page/Cancel
- Zoom
- Browser Settings
- Delete Browser Data

- ▶ Select an option.
- ▶ Make the desired changes to the settings.

Calling up the web browser settings

Multimedia system:

 Connect >>  Browser
 >>  Options >> Browser Settings

The following functions are available:

- Block Pop-Ups
- Activate Javascript
- Allow Cookies

- ▶ Activate or deactivate the function.

Deleting browser data

Multimedia system:

 Connect >>  Browser
 >>  Options >> Delete Browser Data

The following options are available:

- All
- Cache
- Cookies
- Entered URLs
- Form Data

- ▶ Select an option.
- ▶ Select Yes.

Managing bookmarks

Multimedia system:

 Connect >>  Browser
 >>  Bookmarks

Selecting a bookmark

- ▶ Select an entry.

Creating a bookmark

- ▶ Select **Add New Bookmark**.
- ▶ Enter a URL and a name.
- ▶ Select **ok**.

Editing a bookmark

- ▶ Highlight a bookmark.
- ▶ Select .
- ▶ Select **Edit**.
- ▶ Enter a URL and a name.
- ▶ Select **ok**.

Deleting a bookmark

- ▶ Highlight a bookmark.
- ▶ Select .
- ▶ Select **Delete**.
- ▶ Select **Yes**.

Closing the browser

Multimedia system:

- ▶  Connect >>  Browser
- ▶ Select  **Close Browser**.

Internet radio

Calling up Internet radio Requirements:

- The Internet radio service is activated.
- The data volume is available.
Depending on the country, data volume may need to be purchased.
- A fast Internet connection for data transmission free of interference.
The services are country-dependent.
For more information, consult an authorized Mercedes-Benz Center.

Multimedia system:

→ Radio →  Radio Source

- ▶ Select **Tuneln Radio**.
The Internet radio display appears. The last station set starts playing.
- ⓘ The connection quality depends on the local mobile phone reception.

Internet radio overview

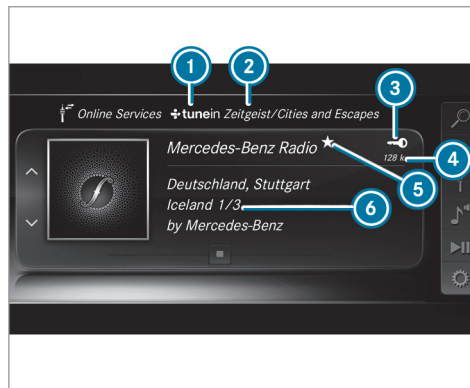

- 1 Internet radio provider
- 2 Selected category
- 3 Display (if connected to private user account)
- 4 Data transfer rate
- 5 Current station is stored as a favorite
- 6 Additional information on the current station

Selecting and connecting Internet radio stations

Multimedia system:

→ Radio →  Radio Source
→ Tuneln Radio →  Search

- ▶ Select a category.
- ▶ Select a station.
The connection is established automatically.

or

- ▶ Select **Enter Address or POI**.
- ▶ Enter a station name using the entry field.



- ⓘ A relatively large volume of data can be transmitted when using Internet radio.

Saving/deleting an Internet radio station as a favorite



Multimedia system:

→ Radio →  Radio Source
→ Tuneln Radio

- ▶ Select a station.

- ▶ Press and hold the central control element until an audible signal sounds. The  symbol appears by the station name.
 - ▶ Select  **Favorites**. The list of saved favorite stations appears.
- or
- ▶ Create an account for the online provider (TuneIn radio) and then log in on the multimedia system. Your favorites are imported to the multimedia system.

Deleting favorites

- ▶ Select  **Favorites**.
- ▶ Select a station.
- ▶ Press and hold the central control element until an audible signal sounds. The  symbol by the station name disappears.

Setting Internet radio options

Multimedia system:

- ▶  **Radio** ▶▶  **Radio Source**
- ▶▶ **TuneIn Radio** ▶▶  **Options**

The following options are available:

- **Select Stream:** select the stream quality.
 - **Login to TuneIn Account:** log in to your TuneIn user account.
 - **Log Out of Account:** log out of your TuneIn user account.
- ▶ Select an option.

Media

Audio mode

Information on the audio mode

 **WARNING** Risk of distraction when handling data storage media

If you handle a data storage medium while driving, your attention is diverted from the

traffic conditions. This could also cause you to lose control of the vehicle.

- ▶ Only handle a data storage medium when the vehicle is stationary.

Permissible file systems:

- FAT32
- exFAT
- NTFS

Permissible data storage medium:

- SD card
- USB storage device
- iPod®/iPhone®
- MTP devices
- Bluetooth® audio equipment

 Observe the following notes:

- The multimedia system supports a total of up to 50,000 files.
- Data storage media up to 2 TB are supported (32-bit address space).

Supported formats:

- MP3
- WMA
- AAC
- WAV
- FLAC
- ALAC

i Observe the following notes:

- Due to the large variety of available music files regarding encoders, sampling rates and data rates, playback cannot always be guaranteed.
- Due to the wide range of USB devices available on the market, playback cannot be guaranteed for all USB devices.
- Copy-protected music files or DRM encrypted files cannot be played back.
- MP3 players must support Media Transfer Protocol (MTP).



Manufactured under license from Dolby Laboratories. Dolby, Dolby Audio and the double-D symbol are trademarks of Dolby Laboratories.



Gracenote, the Gracenote logo and logotype, "Powered by Gracenote", MusicID and Playlist Plus are either registered trademarks or trademarks of Gracenote, Inc. in the United States and/or other countries.



"Made for iPod", and "Made for iPhone," mean that an electronic accessory has been designed to connect specifically to iPod, or iPhone, respectively, and has been certified by the developer to meet Apple performance standards. Apple is not responsible for the operation of this device or its compliance with safety and regulatory standards. Please note that the use of this accessory with iPod, or iPhone may affect wireless performance.

For the USA: iPhone®, iPod®, iPod classic®, iPod nano®, and iPod touch® are trademarks of Apple Inc., registered in the U.S. and other countries. Lightning™ is a trademark of Apple Inc.

For Canada: iPhone, iPod, iPod classic, iPod nano, and iPod touch are trademarks of Apple Inc., registered in the U.S. and other countries. Lightning is a trademark of Apple Inc.

Notes on copyright

Audio files that you create or reproduce yourself for playback are generally subject to copyright protection. In many countries, reproductions, even for private use, are not permitted without the prior consent of the copyright holder. Make

sure that you know about the applicable copyright regulations and that you comply with these.

Activating media mode

Multimedia system:

→ Media →  Media Sources

- ▶ Select a media source.
▶ Playable music files are played back.

Inserting/removing an SD card

⚠ DANGER Risk of fatal injury from swallowing SD cards

SD cards are small parts.

They could be swallowed and lead to choking.

- ▶ Keep SD cards out of the reach of children.
- ▶ Seek medical attention immediately if an SD card has been swallowed.

⚠ NOTE Damage due to high temperatures

High temperatures may damage the SD card.

- ▶ Remove the SD card after use and take it out of the vehicle.

Multimedia system:

→ Media →  Media Sources

▶ Mem. Card

Inserting

The multimedia connection unit is located in the stowage compartment under the armrest.

- ▶ Insert the SD memory card into the SD card slot until it engages. The side with the contacts must face downwards.
▶ Playable music files are played back.

Removing

- ▶ Press the SD card.
- ▶ Remove the SD card.

Overview of the audio mode

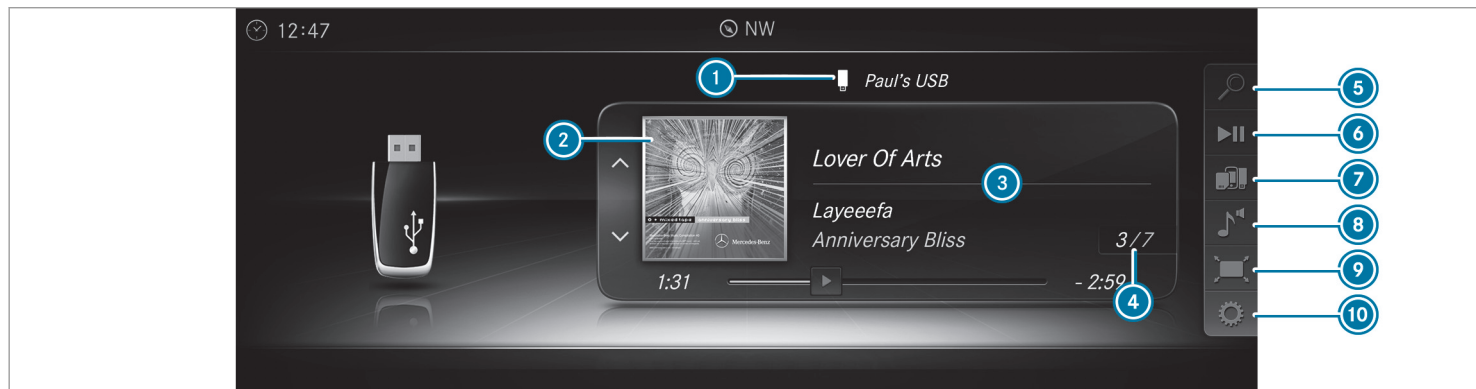

- ① Active data storage medium
- ② Album cover
- ③ Track, artist, album
- ④ Track number and number of tracks in the track list
- ⑤ Search
- ⑥ Playback Control

- ⑦ Media Sources
- ⑧ Sound
- ⑨ Full Screen (for video playback)
- ⑩ Options

Connecting USB devices

! **NOTE** Damage caused by high temperatures

High temperatures can damage USB devices.

▶ Remove the USB device after use and take it out of the vehicle.

The multimedia connection unit is found in the stowage compartment under the armrest and has two USB ports.

Depending on the vehicle's equipment, additional USB ports can be found in the stowage compartment of the center console.

- ▶ Connect the USB device to the USB port. Playable music files are played back only if the corresponding media display is activated.

① Use the USB port identified by  to use Apple CarPlay™ and Android Auto.

Selecting a track in the media playback

Multimedia system:

↳ [Media](#)

Selecting a track by skipping to a track

- ▶ **To skip backwards or forwards to a track:** navigate up or down.

Selecting a track using the current track list

- ▶ Select .
- ▶ Select [Current Track List](#).
- ▶ Select a track.

Selecting playback options

Multimedia system:

↳ [Media](#) ▶  [Options](#)

Playing back similar tracks

- ▶ Select [Play Similar Tracks](#).
A track list with similar tracks is created and played back.

Playback mode



- ▶ Select [Random Mode - Current Playlist](#).
The current track list is played in random order.
- ▶ Select [Random Mode - Current Medium](#).
All tracks on the active data storage medium are played in random order.
- ▶ Select [Normal Track Sequence](#).
The current track list is played in the order it appears on the data storage medium.



Controlling media playback

Multimedia system:

↳ [Media](#) ▶  [Playback Control](#)

A bar with playback controls is shown.

- ▶ **To pause playback:** select and confirm  with the central control element. The  symbol is displayed.

- ▶ **To resume playback:** select and confirm  again with the central control element. The  symbol is displayed.

To fast forward/rewind

- ▶ Move  on the timeline.

To hide the playback controls

- ▶ Press the  button.

Video mode

Switching to video mode

Multimedia system:

↳ [Media](#) ▶  [Media Sources](#)

- ▶ Select a data storage medium.
- ▶ Search for and select video files or playlists with video files.
Playable video files are played back.

The multimedia system supports the following formats:

- MPEG
- AVI, DivX, MKV
- MP4, M4V
- WMV

i If the vehicle is traveling faster than 3 mph (5 km/h) the video image is hidden from the driver. If available, the channel and program information is continuously displayed.

Due to the large variety of available video files regarding encoders, sampling rates and data transfer rates, playback cannot be guaranteed.

Videos up to FullHD (1920x1080) are supported.

Copy-protected video files or DRM (Digital Rights Management) encrypted files cannot be played back.

Overview of video mode

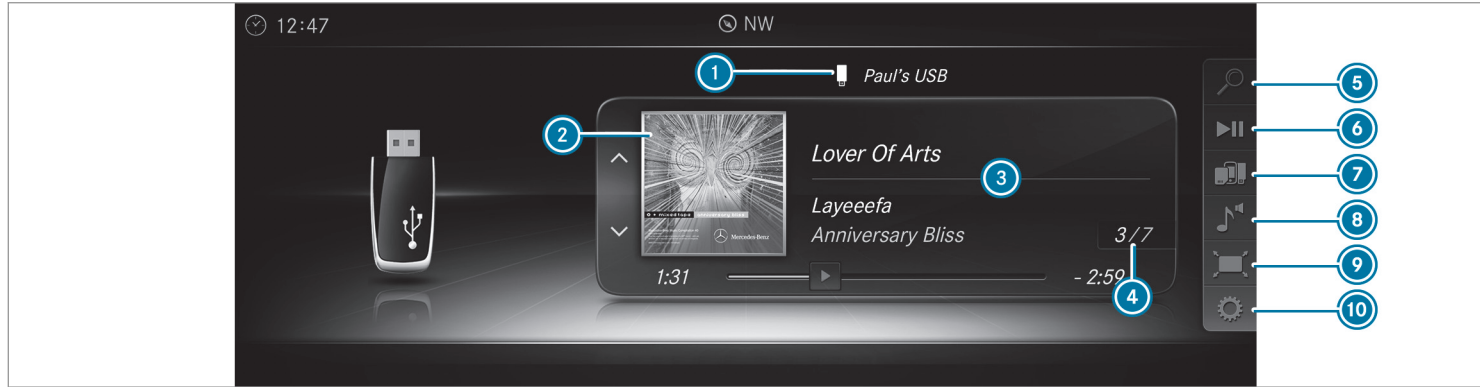

- ① Active data storage medium
- ② Album cover
- ③ Track, artist, album
- ④ Track number and number of tracks in the track list
- ⑤ Search
- ⑥ Playback Control
- ⑦ Media Sources
- ⑧ Sound
- ⑨ Full Screen (for video playback)
- ⑩ Options

Activating/deactivating full-screen mode

Multimedia system:

➤ Media ➤ Media Sources

- ▶ Select a data storage medium.
Playable video files are played back.

- ▶ **To activate full-screen mode:** select Full Screen.

- ▶ **To deactivate full-screen mode:** press the touchpad.

Changing video settings

Multimedia system:

- ↳ Media ▶ ⚙️ Options
- ▶▶ Picture Format

The following picture formats are available:

- Automatic
- 16:9
- 4:3
- Zoom

- ▶ Select a picture format.

Adjusting the brightness manually

If the **Automatic** picture format is switched off, you can adjust the brightness yourself.

- ▶ Select **Brightness**.
- ▶ Adjust the brightness.

Media search

Starting the media search

Multimedia system:

- ↳ Media ▶ 🔍 Search

Depending on the connected media sources and files, the following categories are listed:

- Current Track List
- Keyword Search
- Playlists
- Artists
- Albums
- Tracks
- Folders
- Music Genres
- Year
- Composers
- Videos
- Podcasts (Apple® devices)
- Audiobooks (Apple® devices)

- ▶ Select a category.

- ⓘ The categories are available as soon as the entire media content has been read in and analyzed.

Media Interface

Information about the Media Interface

Media Interface is a universal interface for the connection of mobile audio equipment. The multimedia system has two USB ports. The USB ports are located in the stowage compartment under the armrest.

Supported devices

The Media Interface allows you to connect the following data storage media:

- iPod®
- iPhone®
- MP3 player
- USB devices

For details and a list of supported devices, visit our website at <http://www.mercedes-benz.com/connect>. Follow the instructions in the "Media Interface" section.

Switching to Media Interface

Multimedia system:

Media ► Media Sources

- ▶ Connect a data storage medium to the USB port (→ page 276).
- ▶ Select a media device.
Playable music files are played back.

Overview of Media Interface

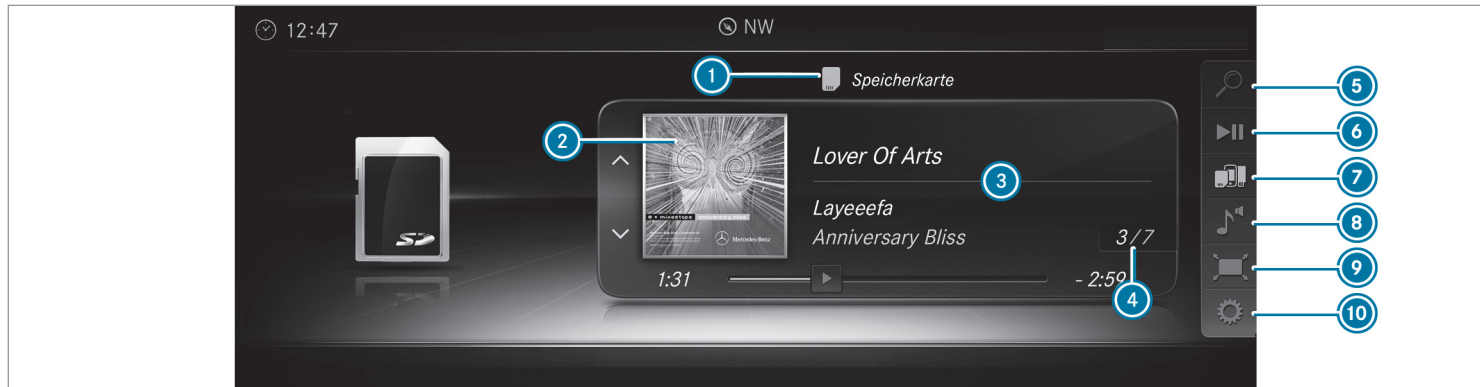

- ① Active data storage medium
- ② Album cover
- ③ Artist, track and album
- ④ Track number and number of tracks in the track list
- ⑤ Search
- ⑥ Playback Control
- ⑦ Media Sources
- ⑧ Sound
- ⑨ Full Screen (video playback only)
- ⑩ Options

Bluetooth® audio

Information about Bluetooth® audio

Before using your Bluetooth® audio equipment with the multimedia system for the first time, you will need to authorize it (→ page 283).

Bluetooth® audio overview

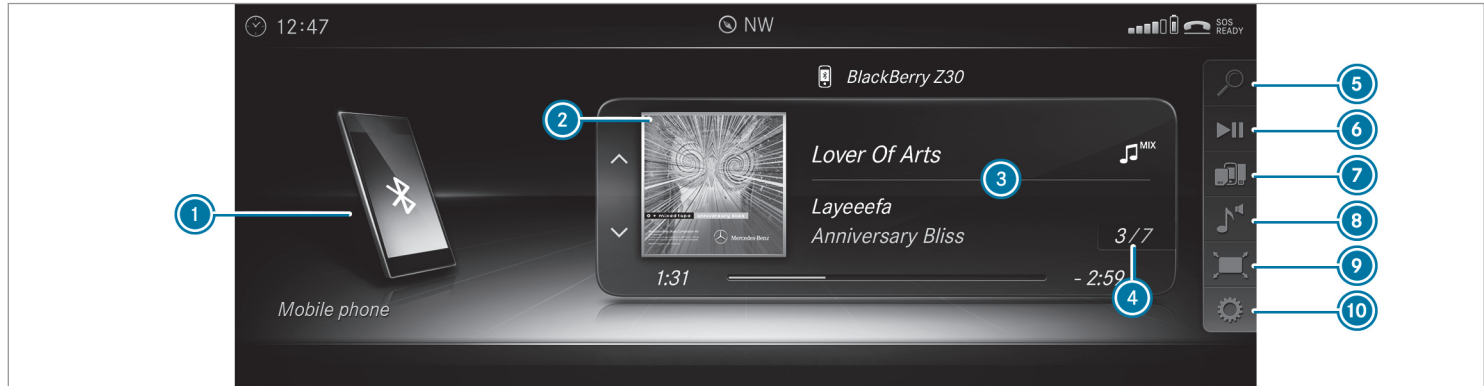

- ① Active data storage medium
- ② Album cover
- ③ Track, artist, album
- ④ Track number and number of tracks in the track list
- ⑤ Search
- ⑥ Playback Control

- ⑦ Media Sources
- ⑧ Sound
- ⑨ Full Screen (video playback only)
- ⑩ Options

Searching for and authorizing a Bluetooth® audio device
Requirements:

- Bluetooth® is activated on the multimedia system and audio equipment (→ page 208).
- The audio equipment supports the Bluetooth® audio profiles A2DP and AVRCP.
- The audio equipment is "visible" for other devices.

Multimedia system:

↳ Media ▶  Media Sources
 ▶  Bluetooth Audio

Authorizing a new Bluetooth® audio device

- ▶ Select .
- ▶ Select **Add New Bluetooth Audio Device**.
- ▶ Select **Start Search on System**.
Detected audio equipment is displayed in the device list.
- ▶ Select a Bluetooth® audio device.
Authorization starts. A code is displayed on the multimedia system and on the mobile phone.
- ▶ If the codes are identical, confirm on the audio equipment.
The audio equipment is connected and playback starts.

Selecting previously authorized Bluetooth® audio equipment

- ▶ Select .
- ▶ Select a Bluetooth® audio device.

Establishing a connection from the Bluetooth® audio equipment

The Bluetooth® device name of the multimedia system is **MB BLUETOOTH XXXXX**.

- ▶ Select **Search from Device**.
- ▶ Start the authorization on the audio equipment (see manufacturer's operating instructions).
A code is displayed on the multimedia system and on the audio device.
- ▶ Confirm on both devices if the codes are identical.
The audio equipment is connected and playback starts.

With some audio equipment, playback must be initially started on the device itself so that the multimedia system can play the audio files.

- ▶  Device-specific information on authorizing and connecting Bluetooth®-capable mobile phones can be obtained at <http://www.mercedes-benz.com/connect> or from an authorized Mercedes-Benz Center.

Activating Bluetooth® audio

Multimedia system:

↳ Media ▶  Media Sources

- ▶ Select  **Bluetooth Audio**.
The multimedia system activates the connected Bluetooth® audio equipment.

Selecting the media player on the Bluetooth® audio device

Multimedia system:

↳ Media ▶ 

- ▶ Select the **Bluetooth Audio Players** category.
If multiple media players are present on the Bluetooth® audio equipment a list appears.
- ▶ Select a media player.
Playback starts.
- ▶  The function is not supported by every mobile phone.

Searching for a music track on the Bluetooth® audio device

Multimedia system:

↳ Media ▶  Media Sources
 ▶  Bluetooth Audio

- ▶ Select .
- ▶ Select a category.
A track list appears.
- ▶ Select a track.

 The function is only available when the mobile phone and the media player selected on the mobile phone support this function.

Disconnecting Bluetooth® audio equipment

Multimedia system:

↳ Phone ▶  Media Sources

- ▶ Select the  symbol in the line of the mobile phone.
The disconnection of the mobile phone takes place without a confirmation prompt. The mobile phone remains authorized in the system.

Radio

Switching on the radio

Multimedia system:

↳ Radio

- ▶ Open the application in the multimedia system.
The radio display appears. You will hear the last station played on the last frequency band selected.

Radio overview



- ① Active frequency band
- ② Station name or set frequency
- ③ Artist, title, album and radio text
- ④ Station list
- ⑤ Presets
- ⑥ Radio Source
- ⑦ Sound

- ⑧ Options

Switching the HD Radio function on/off

Multimedia system:

↳ Radio ▶ ⚙️ Options ▶ HD Radio



- ▶ Switch the function on or off .

i HD Radio Technology manufactured under license from iBiquity Digital Corporation. U.S. and Foreign Patents. HD Radio™ and the HD, HD Radio and "Arc" logos are proprietary trademarks of iBiquity Digital Corp.

Setting the waveband

Multimedia system:

↳ Radio ▶ Radio Source

HD Radio FM HD Radio AM and SiriusXM Radio can be selected.

- ▶ Select a frequency band.

Selecting a radio station

Multimedia system:

↳ Radio

- ▶ Navigate up or down.

Calling up the radio station list

Multimedia system:

↳ Radio ▶

- ▶ Select a station.

Searching for radio stations using station names or direct frequency entry

Multimedia system:

↳ Radio ▶ ▶

- ▶ Enter a station name or frequency.
- ▶ Select .
- ▶ The search results are displayed.
- ▶ Select a station.

Storing radio stations

Multimedia system:

↳ Radio ▶ Presets

- ▶ Select Store Current Station in the Presets.

Editing radio station presets

Multimedia system:

↳ Radio ▶ Presets

Moving stations:

- ▶ Highlight a preset entry and navigate to the left.

- ▶ Select **Move Highlighted Station**.
- ▶ Select a memory preset.

Deleting stations:

- ▶ Highlight a preset entry and navigate to the left.
- ▶ Select **Delete Highlighted Station**.
- ▶ Select **Yes**.

Activating/deactivating radio text

Multimedia system:

- ↳ **Radio** ▶▶  **Options**
- ▶▶ **Display Radio Text Information**
- ▶ Activate or deactivate the function.

Satellite radio

Information on the satellite radio

SIRIUS XM® satellite radio offers more than 175 digital-quality radio channels providing 100% commercial-free music, sports, news and entertainment, for example. SIRIUS XM satellite radio employs a fleet of high-performance satellites to

broadcast around the clock throughout the USA and Canada. The satellite radio program is available for a monthly fee. Information about this can be obtained from a Sirius XM® Service Center and at <http://www.siriusxm.com> (USA) or <http://www.siriusxm.ca> (Canada).

- ⓘ Sirius, XM and all related marks and logos are trademarks of Sirius XM Radio Inc. and its subsidiaries. All other marks, channel names and logos are the property of their respective owners. All rights reserved.

Satellite radio restrictions

Satellite radio mode may be temporarily unavailable or interrupted for a variety of reasons. These include environmental or topographical conditions beyond the control of Mercedes-Benz USA, LLC. Thus, operation at certain locations may not be possible.

Registering satellite radio Requirements:

- Satellite radio equipment
- Registration with a satellite radio provider

- If registration is not included when purchasing the system, your credit card details will be required to activate your account

Multimedia system:

- ↳ **Radio** ▶▶  **Radio Source**
- ▶▶ **SiriusXM Radio** ▶▶  **Options**

- ▶ Select **Service Information**.
The service information screen appears showing the radio ID and the current subscription status.
- ▶ Establish a telephone connection.
- ▶ Follow the service staff's instructions.
The activation process may take up to ten minutes.
- ⓘ You can also have the satellite service activated online. To do so, please visit <http://www.siriusxm.com> (USA) or <http://www.siriusxm.ca> (Canada).

Switching on satellite radio

Multimedia system:

- ↳ **Radio** ▶▶  **Radio Source**
- ▶ Select **SiriusXM Radio**.

Overview of the satellite radio

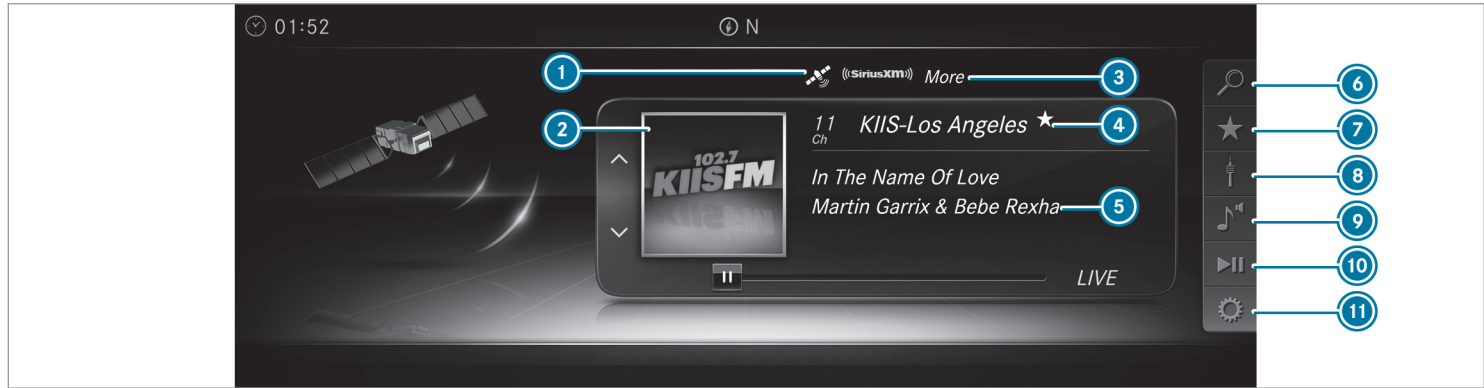

- ① Active frequency band
- ② Logo or cover picture for the song (if available)
- ③ Category
- ④ Channel name
- ⑤ Artist, track and album
- ⑥ SiriusXM Radio Channels

- ⑦ Presets
- ⑧ Radio Source
- ⑨ Sound
- ⑩ Playback Control
- ⑪ Options

Selecting a satellite radio category

Multimedia system:

- Radio ➤ Radio Source
- SiriusXM Radio
- SiriusXM Radio Channels ➤ Category
- Select a category.

Selecting a satellite radio channel

Multimedia system:

↳ Radio ▶  Radio Source

▶▶ SiriusXM Radio

- ▶ Navigate up or down.

Saving or deleting a satellite radio channel

Multimedia system:

↳ Radio ▶  Radio Source▶▶ SiriusXM Radio ▶▶  Presets

- ▶ Select Store Current Station in the Presets.

Moving a channel

- ▶ Select Options.
- ▶ Select Move Highlighted Station.
- ▶ Select a memory preset.

Deleting a channel

- ▶ Select Delete Highlighted Station.
- ▶ Select a memory preset.

Displaying EPG information for the current channel

Multimedia system:

↳ Radio ▶  Radio Source▶▶ SiriusXM Radio ▶▶  Options

- ▶ Select EPG Information about Current Channel.

Setting parental control for radio

Multimedia system:

↳ Radio ▶  Radio Source▶▶ SiriusXM Radio ▶▶  Options

▶▶ Parental Control

- ▶ Activate the function .
- ▶ Determine a four-digit character sequence and select **OK**.
- ▶ All channels with adult content are locked.

Unlocking a channel

- ▶ Enter the four-digit character sequence and select **OK**.
- ▶ All channels with adult content are unlocked.

Music and sport alerts function

This function enables you to program an alert for your favorite artists, tracks or sporting events. Music alerts can be saved whilst a track is being played and sport alerts can be saved during a live game. You can also specify sport alerts via the menu option. The system then continuously searches through all the channels. If a match is found with a stored alert, you will be informed.

Setting music and sport alerts

Multimedia system:

↳ Radio ▶  Radio Source▶▶ SiriusXM Radio ▶▶  Options

▶▶ Alert for Artist, Song & Sporting Event

Setting a music alert

- ▶ Select Add New Alert.

or

- ▶ Select Manage Artist & Song Alerts.
- ▶ Select  Options.

The following options are available:

- Mark This Entry
- Unmark This Entry

- [Mark All Entries](#)
- [Unmark All Entries](#)
- [Delete This Entry](#)
- [Delete All Entries](#)

▶ Select an option.

▶ [Activate Artist & Song Alerts](#) .

The alert is set for the current artist or track. If a match is found, a prompt appears asking whether you wish to change to the station.

Setting a sport alert

▶ Select [Add New Alert](#).

or

▶ Select [Manage Sports Alerts](#).

▶ Select [Select New Alerts](#).

or

▶ Select [Edit Alerts](#).

▶ Select a team from a league.

▶ [Activate Sports Alerts](#) .

Information on Smart Favorites and Tune Start

Stations in the station presets can be added as Smart Favorites. Smart Favorites stations are automatically saved to temporary storage in the background. If you change to a Smart Favorites station, you can replay, pause or actively skip forward or back to broadcasts which you have missed. If Tune Start is activated and you change to another Smart Favorites station, the music track currently playing on the station is automatically restarted from the beginning of the track.

Adding a channel to Smart Favorites

Multimedia system:

↳ [Radio](#) ▶ [Radio Source](#)
▶ [SiriusXM Radio](#)

▶ Select the active frequency band.

▶ Highlight an entry.

▶ Select .

▶ Select [Add Highlighted Channel to Smart Favorites](#).

Activating/deactivating TuneStart

Multimedia system:

↳ [Radio](#) ▶ [Options](#) ▶ [TuneStart](#)

▶ Activate or deactivate the function.

Controlling playback

Multimedia system:

↳ [Radio](#) ▶ [Playback Control](#)

You can pause the playback of the current station or skip forward or backward in the timeline. This leaves live mode to access the internal temporary storage.

▶ **To pause playback:** select .

▶ **To return to live mode:** navigate to the end of the timeline.

Displaying satellite radio service information

Multimedia system:

↳ [Radio](#) ▶ [Radio Source](#)

▶ [SiriusXM Radio](#) ▶ [Options](#)

▶ Select [Service Information](#).

Sound

Tone settings

Information about the sound system

The sound system has a total output of 100 W and is equipped with four speakers. It is available for all functions in the radio and media modes.

Calling up the sound menu

Multimedia system:

Media ▶ Sound

The following functions are available:

- Equalizer
- Balance
- Automatic Volume Adjustment
- Other Sound Settings

▶ Select a sound menu.

Adjusting treble, mid-range and bass settings

Multimedia system:

Media ▶ Sound ▶ Equalizer

- ▶ Select **Treble**, **Mid Range** or **Bass**.
- ▶ Change the settings.

Activating/deactivating automatic volume adjustment

Multimedia system:

Media ▶ Sound

▶ Automatic Volume Adjustment

Automatic volume adjustment compensates for differing volumes when changing between audio sources.

- ▶ Activate or deactivate the function.

Adjusting the balance

Multimedia system:

Media ▶ Sound ▶ Balance

- ▶ Adjust the balance.
- ▶ **To exit the menu:** press the  button.

Burmester® surround sound system

Information about the Burmester® surround sound system

The Burmester® surround sound system has a total output of 640 W and is equipped with ten speakers. It is available for all functions in the radio and media modes.

Calling up the sound menu in the Burmester® surround sound system

Multimedia system:

Media ▶ Sound

The following functions are available:

- Equalizer
 - Balance
 - Automatic Volume Adjustment
 - Surround Sound
 - Other Sound Settings
- ▶ Select a function.

Adjusting the treble, mid and bass settings on the Burmester® surround sound system

Multimedia system:

↳ Media ▶ Sound ▶ Equalizer

- ▶ Select **Treble**, **Mid Range** or **Bass**.
- ▶ Set the desired values.

ⓘ Recommended setting for treble, mid-range and bass: Setting 0.

Activating/deactivating volume adjustment in the Burmester® surround sound system

Multimedia system:

↳ Media ▶ Sound

▶ Automatic Volume Adjustment

Automatic volume adjustment compensates for differing volumes when changing between audio sources.

- ▶ Activate or deactivate the function.

Adjusting the balance in the Burmester® surround sound system

Multimedia system:

↳ Media ▶ Sound ▶ Balance

- ▶ Adjust the balance.

▶ **To exit the menu:** press the  button.

ⓘ Recommended setting for balance: Setting 0.

Switching surround sound on/off in the Burmester® surround sound system

Multimedia system:

↳ Media ▶ Sound

▶ Surround Sound

- ▶ Activate or deactivate the function.

Burmester® high-end Surround sound system

Information on the Burmester® high-end Surround sound system

The Burmester® high-end Surround sound system has a total output of 1000 watts and is

equipped with 11 speakers. It is available for all functions in the radio and media modes.

Calling up the sound menu in the Burmester® high-end Surround sound system

Multimedia system:

↳ Media ▶ Sound

The following functions are available:

- Equalizer
- Balance
- Automatic Volume Adjustment
- VIP Seat (seat-based sound optimization)
- Sound Profiles
- Other Sound Settings
- ▶ Select a sound menu.

Adjusting the treble, mid-range and bass settings on the Burmester® high-end Surround sound system

Multimedia system:

→ Media →  Sound → Equalizer

- ▶ Select **Treble**, **Mid Range** or **Bass**.
- ▶ Set the desired values.
- ⓘ Recommended setting for treble, mid-range and bass: Setting 0.

Activating/deactivating volume adjustment in the Burmester® high-end Surround sound system

Multimedia system:

→ Media →  Sound
▶ Automatic Volume Adjustment

Automatic volume adjustment compensates for differing volumes when changing between audio sources.

- ▶ Activate or deactivate the function.

Adjusting the balance in the Burmester® high-end Surround sound system

Multimedia system:

→ Media →  Sound → Balance

- ▶ Adjust the balance.
- ▶ **To exit the menu:** press the  button.
- ⓘ Recommended setting for balance: Setting 0.

Adjusting the seat-based sound optimization in the Burmester® high-end Surround sound system

Multimedia system:

→ Media →  Sound → VIP Seat

This setting optimizes the sound playback for the selected seat position.

- ▶ Activate the function .
- ▶ Select a seat position.

Selecting the sound profile in the Burmester® high-end Surround sound system

Multimedia system:

→ Media →  Sound → Sound Profiles

The following profiles are available:

- [Pure](#)
 - [Easy Listening](#)
 - [Live](#)
 - [Surround](#)
- ▶ Select a sound profile.

ASSYST PLUS service interval display

Function of the ASSYST PLUS service interval display

The ASSYST PLUS service interval display on the Instrument Display provides information on the remaining time or distance before the next service due date.

You can hide this service display using the back button on the left-hand side of the steering wheel.

Depending on how the vehicle is used, the ASSYST PLUS service interval display may shorten the service interval, e.g. in the following cases:

- Mainly short-distance driving
- When the engine is often left idling for long periods
- In the event of frequent cold start phases

Mercedes-Benz recommends avoiding such operating conditions.

You can obtain information concerning the servicing of your vehicle from a qualified specialist

workshop, e.g. an authorized Mercedes-Benz Center.

Displaying the service due date

On-board computer:

↳ Service ► ASSYST PLUS

The next service due date is displayed.

► **To exit the display:** press the back button on the left-hand side of the steering wheel.

Make sure to observe the following further related subject:

- Operating the on-board computer (→ page 170).

Information on regular maintenance work

! **NOTE** Premature wear through failure to observe service due dates

Service work which is not carried out at the right time or incompletely can lead to increased wear and damage to the vehicle.

- Always observe the prescribed service intervals.
- Always have the prescribed service work carried out at a qualified specialist workshop.

Special service requirements

The prescribed service interval is based on normal operation of the vehicle. Maintenance work will need to be performed more often if the vehicle is operated under arduous conditions or increased loads.

The ASSYST PLUS service interval display is only an aid. The driver of the vehicle bears responsibility as regards to whether maintenance work needs to be performed more often than specified based on the actual operating conditions and/or loads.

Examples of arduous operating conditions:

- regular city driving with frequent intermediate stops
- mainly short-distance driving

- frequent operation in mountainous terrain or on poor road surfaces
- when the engine is often left idling for long periods
- operation in particularly dusty conditions and/or if air-recirculation mode is frequently used

In these or similar operating conditions, have the interior air filter, engine air cleaner, engine oil and oil filter etc. changed more frequently. The tires must be checked more frequently if the vehicle is operated under increased loads. Further information can be obtained at a qualified specialist workshop.

Battery disconnection periods

The ASSYST PLUS service interval display can only calculate the service due date when the battery is connected.

- ▶ Note down the service due date displayed on the instrument display before disconnecting the battery (→ page 295).

Engine compartment

Opening/closing the hood

⚠ WARNING Risk of accident if the engine hood is unlatched while driving

An unlocked engine hood may open up when the vehicle is in motion and block your view.

- ▶ Never unlatch the engine hood while driving.
- ▶ Before every trip, ensure that the engine hood is latched.

⚠ WARNING Risk of accident and injury when opening and closing the engine hood

When opening or closing the engine hood, it may suddenly drop into the end position.

There is a risk of injury for anyone in the engine hood's range of movement.

- ▶ Only open or close the engine hood when there are no persons in the engine hood's range of movement.

⚠ WARNING Danger of burns when opening the hood

If you open the hood when the engine has overheated or during a fire in the engine compartment, you could come into contact with hot gases or other escaping operating fluids.

- ▶ Before opening the hood, allow the engine to cool down.
- ▶ In the event of a fire in the engine compartment, keep the hood closed and call the fire service.

⚠ WARNING Risk of injury due to moving parts

Certain components in the engine compartment may continue to move or suddenly move again even after the ignition has been switched off, e.g. the cooler fan.

Make sure of the following before performing tasks in the engine compartment:

- ▶ Switch the ignition off.

- ▶ Never touch the danger zone surrounding moving component parts, e.g. the rotation area of the fan.
- ▶ Remove jewelry and watches.
- ▶ Keep items of clothing and hair away from moving parts.

⚠ WARNING Risk of injury from touching component parts under voltage

The ignition system and the fuel injection system work under high voltage. If you touch component parts which are under voltage, you could receive an electric shock.

- ▶ Never touch component parts of the ignition system or the fuel injection system when the ignition is switched on.

⚠ WARNING Risk of burns from hot component parts in the engine compartment

Certain components in the engine compartment can be very hot, e.g. the engine, the radiator and parts of the exhaust system.

- ▶ Allow the engine to cool down and only touch component parts described in the following.

⚠ WARNING Risk of injury from using the windshield wipers while the engine hood is open

When the engine hood is open and the windshield wipers are set in motion, you can be trapped by the wiper linkage.

- ▶ Always switch off the windshield wipers and ignition before opening the engine hood.

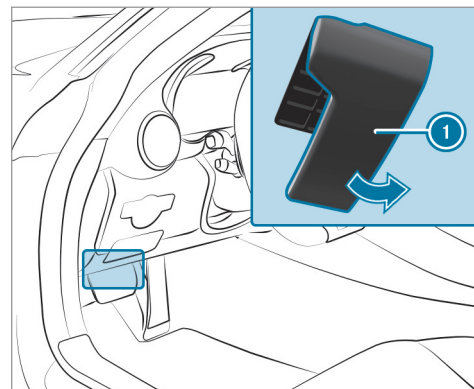

- ▶ **To open:** pull lever ① to release the hood.

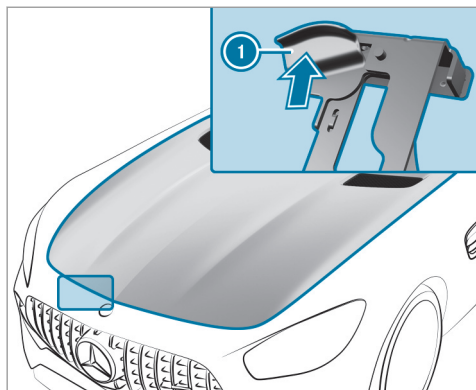

- ▶ Push handle ① of the hood catch upwards and lift the hood by approximately 15 in (40 cm).
- ▶ **To close:** lower the hood and let it fall from a height of approximately 8 in (20 cm).
- ▶ If the hood can still be lifted slightly, open the hood again and close it with a little more force until it engages correctly.

Engine oil

Checking the engine oil level using the oil dipstick

⚠ WARNING Risk of burns from hot component parts in the engine compartment

Certain components in the engine compartment can be very hot, e.g. the engine, the radiator and parts of the exhaust system.

- ▶ Allow the engine to cool down and only touch component parts described in the following.

The waiting time before checking the oil level when the engine is at normal operating temperature is two minutes.

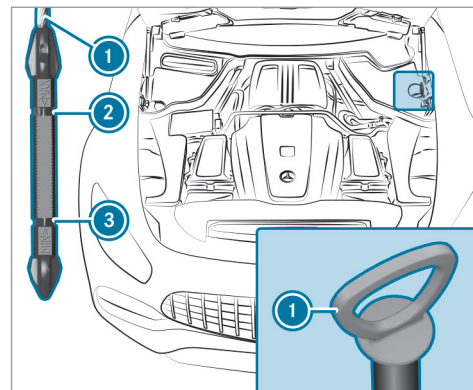

- ▶ Park the vehicle on a level surface.
- ▶ Pull oil dipstick ① out and wipe off.

- ▶ Slowly slide oil dipstick ① into the guide tube to the stop, and take it out again after approximately three seconds.

The following measurement results are possible:

- Oil level is correct: oil level is between ② and ③.
 - Oil level too low: oil level is at ③ or below.
 - Oil level too high: oil level is above ②.
- ▶ If the oil level is too low, add 1.1 US qt (1 liter) of engine oil.
 - ▶ If the oil level is too high, drain off excess engine oil. Consult a qualified specialist workshop.

Adding engine oil

⚠ WARNING Risk of burns from hot component parts in the engine compartment

Certain components in the engine compartment can be very hot, e.g. the engine, the radiator and parts of the exhaust system.

- ▶ Allow the engine to cool down and only touch component parts described in the following.

⚠ WARNING Risk of fire and injury from engine oil

If engine oil comes into contact with hot component parts in the engine compartment, it may ignite.

- ▶ Make sure that no engine oil is spilled next to the filler opening.
- ▶ Allow the engine to cool off and thoroughly clean the engine oil from component parts before starting the vehicle.

⚠ NOTE Engine damage caused by an incorrect oil filter, incorrect oil or additives

- ▶ Do not use engine oils or oil filters which do not correspond to the specifications explicitly prescribed for the service intervals.

- ▶ Do not alter the engine oil or oil filter in order to achieve longer change intervals than prescribed.
- ▶ Do not use additives.
- ▶ Follow the instructions in the service interval display regarding the oil change.

⚠ NOTE Damage caused by adding too much engine oil

Too much engine oil can damage the engine or the catalytic converter.

- ▶ Have excess engine oil removed at a qualified specialist workshop.

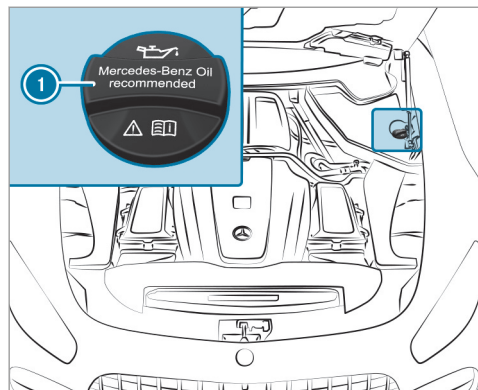

- ▶ Turn cap ❶ counter-clockwise and remove it.
- ▶ Add engine oil.
- ▶ Replace cap ❶ and turn it clockwise as far as it will go.
- ▶ Check the oil level again (→ page 298).

Checking coolant level

⚠ WARNING Risk of burns from hot component parts in the engine compartment

Certain components in the engine compartment can be very hot, e.g. the engine, the radiator and parts of the exhaust system.

- ▶ Allow the engine to cool down and only touch component parts described in the following.

⚠ WARNING Risk of scalding from hot coolant

The engine cooling system is pressurized, particularly when the engine is warm. If you open the cap, you could be scalded by hot coolant spraying out.

- ▶ Let the engine cool down before opening the cap.
- ▶ When opening the cap, wear protective gloves and safety glasses.
- ▶ Open the cap slowly to release pressure.

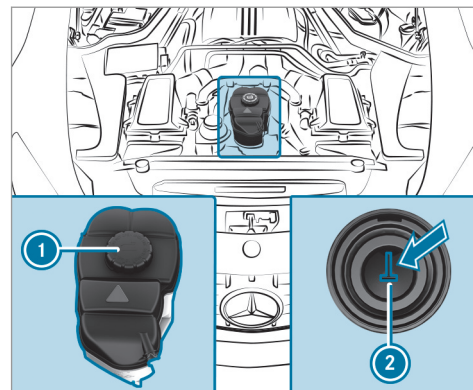

- ▶ Park the vehicle on a level surface.
- ▶ Check the coolant temperature display in the instrument cluster. The coolant temperature must be in the bottom quarter of the temperature display.
- ▶ Slowly turn cap ❶ counter-clockwise to relieve overpressure.

- ▶ Continue turning cap ① counter-clockwise and remove it.

The coolant level is correct in the following cases:

- If the engine is cold, the coolant is up to marker bar ②.
 - If the engine is warm, the coolant is up to 0.6 in (1.5 cm) over marker bar ②.
- ▶ If necessary, add coolant that has been approved for Mercedes-Benz.
- Further information on coolant (→ page 366).

Adding washer fluid to the windshield washer system

- ⚠ **WARNING** Risk of burns from hot component parts in the engine compartment

Certain components in the engine compartment can be very hot, e.g. the engine, the radiator and parts of the exhaust system.

- ▶ Allow the engine to cool down and only touch component parts described in the following.

- ⚠ **WARNING** Danger of burns when opening the hood

If you open the hood when the engine has overheated or during a fire in the engine compartment, you could come into contact with hot gases or other escaping operating fluids.

- ▶ Before opening the hood, allow the engine to cool down.
- ▶ In the event of a fire in the engine compartment, keep the hood closed and call the fire service.

- ⚠ **WARNING** - Risk of fire and injury from windshield washer concentrate

Windshield washer concentrate is highly flammable. It could ignite if it comes into contact with hot engine component parts or the exhaust system.

- ▶ Make sure that no windshield washer concentrate spills out next to the filler opening.

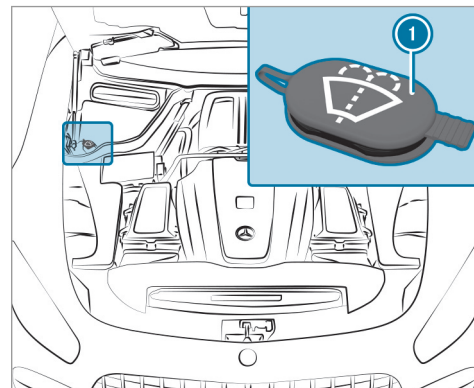

- ▶ Remove cap ① by the tab.
- ▶ Add washer fluid.

Keeping the air-water duct free

- ▶ Keep the area between the hood and the windshield free of deposits, e.g. ice, snow and leaves.

Cleaning and care

Notes on washing the vehicle in a car wash

⚠ WARNING Risk of accident due to reduced braking effect after washing the vehicle

The braking effect is reduced after washing the vehicle.

- ▶ After the vehicle has been washed, brake carefully while paying attention to the traffic conditions until the braking effect has been fully restored.

! **NOTE** Damage due to unsuitable car wash

- ▶ Before driving into a car wash make sure that the car wash is suitable for the vehicle dimensions.
- ▶ Ensure there is sufficient ground clearance between the underbody and the guide rails of the car wash.
- ▶ Ensure that the clearance width of the car wash, in particular the width of the guide rails, is sufficient.

To avoid damage to your vehicle when using a car wash, ensure the following beforehand:

- to avoid possible water ingress in the vehicle, it is preferable to use car washes which allow the high-pressure pre-cleaning to be deactivated (specification for the convertible program).
- it is imperative to avoid a subsequent hot-wax treatment.
- remove the SmartKey in order to ensure that the wind deflector on the windshield retracts.

- Active Distance Assist DISTRONIC and the HOLD function are deactivated.
- the active aerodynamic profile is fully retracted.
- the side windows and soft top are closed completely.
- the blower for the ventilation/heating is switched off.
- the windshield wiper switch is in position **O**.
- the SmartKey is at a minimum distance of 10 ft (3 m) away from the vehicle, otherwise the trunk lid could open unintentionally.
- in car washes with a conveyor system: neutral **N** is engaged.
- i** In car washes with a conveyor system: if you would like to leave the vehicle while it is being washed, make sure the SmartKey is located in the vehicle. The park position **P** is otherwise automatically engaged.
- i** If, after the car wash, you remove the wax from the windshield and wiper rubbers, this will prevent smearing and reduce wiper noise.

Information on using a power washer

⚠ WARNING Risk of accident when using high-pressure cleaning equipment with round-spray nozzles

The water jet from a round-spray nozzle (dirt grinder) may cause damage to tires and suspension components that is not visible.

Components damaged in this way may fail unexpectedly.

- ▶ Do not use high-pressure cleaning equipment with round-spray nozzles to clean your vehicle.
- ▶ Damaged tires or suspension components must be replaced immediately.

To avoid damage to your vehicle, observe the following when using a power washer:

- keep the SmartKey at least 10 ft (3 m) away from the vehicle. Otherwise the trunk lid could open unintentionally.
- maintain a distance of at least 11.8 in (30 cm) to the vehicle.

- **vehicles with decorative foil:** parts of your vehicle are covered with a decorative foil. Maintain a distance of at least 27.6 in (70 cm) between the foil-covered parts of the vehicle and the nozzle of the power washer. Move the power washer nozzle around whilst cleaning. The water temperature of the power washer must not exceed 140 °F (60 °C).
- observe the information on the correct distance in the equipment manufacturer's operating instructions.
- do not point the nozzle of the power washer directly at sensitive parts such as tires, the soft top, the wind deflector net, slits, electrical component parts, batteries, light sources and ventilation slots.

Washing the vehicle by hand

Observe the legal requirements, e.g. in a number of countries, washing by hand is only permitted in specially designated wash bays.

- ▶ Use a mild cleaning agent, e.g. car shampoo.

- ▶ Wash the vehicle with lukewarm water using a soft car sponge. When doing so, do not expose the vehicle to direct sunlight.
- ▶ Carefully hose the vehicle off with water and dry using a chamois. Take care not to point the water jet directly towards the air inlet grille below the hood.

Notes on paintwork/matte finish paintwork care

Observe the following information:

	Cleaning and care	Avoiding paintwork damage
Paintwork	<ul style="list-style-type: none">• Insect remains: soak with insect remover and rinse off the treated areas afterwards.• Bird droppings: soak with water and rinse off afterwards.• Tree resin, oils, fuels and greases: remove by rubbing gently with a cloth soaked in petroleum ether or lighter fluid.• Coolant and brake fluid: remove with a damp cloth and clean water.• Tar stains: use tar remover.• Wax: use silicone remover.	<ul style="list-style-type: none">• Do not attach stickers, films or similar.• Remove dirt immediately, where possible.

Cleaning and care		Avoiding paintwork damage
Matte finish	<ul style="list-style-type: none"> • Only use care products approved for Mercedes-Benz. 	<ul style="list-style-type: none"> • Do not polish the vehicle and alloy wheels. • Only use car washes that correspond to the latest engineering standards. • Do not use car wash programs with a final hot wax treatment. • Do not use paint cleaners, buffing or polishing products, gloss preservers, e.g. wax. • Always have paintwork repairs carried out at a qualified specialist workshop.

Notes on cleaning decorative foils

Observe the notes on matte finish care in the chapter "Notes on paintwork/matte finish paint-

work care" (→ page 304). They also apply to matte decorative foils.

Observe the following information:

Cleaning	Avoiding damage to the decorative foil
<ul style="list-style-type: none">• For cleaning, use plenty of water and a mild cleaning agent without additives or abrasive substances, e.g. a car shampoo approved for Mercedes-Benz.• Remove dirt immediately, where possible, whilst avoiding rubbing too hard. There is otherwise a risk of damaging the decorative foil irreparably.• If there is dirt on the finish or if the decorative foil is dull: use the Paint Cleaner recommended and approved for Mercedes-Benz.• Insect remains: soak with insect remover and rinse off the treated areas afterwards.• Bird droppings: soak with water and rinse off afterwards.• To prevent water stains, dry a foil-wrapped vehicle with a soft, absorbent cloth after every car wash.	<ul style="list-style-type: none">• The service life and color of decorative foils are impaired by:<ul style="list-style-type: none">- Sunlight- Temperature, e.g. hot air blower- Weather conditions- Stone chippings and dirt- Chemical cleaning agents- Oily products• Do not use polish on matte decorative foil. Polishing will have the effect of shining the foil-wrapped surface.• Do not treat matte or structured decorative foils with wax. Permanent stains may occur.

Scratches, corrosive deposits, areas affected by corrosion and damage caused by incorrect care cannot always be completely repaired. In such cases, visit a qualified specialist workshop.

You can obtain more information on care and cleaning products from the manufacturer.

In the case of foil-wrapped surfaces, optical differences may occur between the surfaces that were not protected by a decorative foil after removing a decorative foil.

i Have work or repairs to decorative foils carried out at a qualified specialist workshop, e.g. in an authorized Mercedes-Benz Center.

Notes on cleaning and care of the soft top

Observe the following information:

Notes on cleaning and care		Avoiding soft-top damage
Light soiling	<ul style="list-style-type: none"> • Clean the soft top when dry. • Rinse with clean water. 	<ul style="list-style-type: none"> • Never use gasoline, thinners, tar remover or stain remover or other organic solvents. • Remove bird droppings immediately, as they are corrosive and can therefore cause the soft-top fabric to leak. • Never use a high-pressure cleaner. • Do not use sharp-edged equipment to remove ice and snow.
Normal to heavy soiling	<ul style="list-style-type: none"> • Clean the soft top with a brush and clean water. • Clean stains and other dirt with a brush and soft-top cleaning agents recommended and approved by Mercedes-Benz. • Always brush from front to back in the direction of the fabric. 	

Frequent cleaning reduces the soft top's resistance to dirt. To restore the effect, clean the soft top with the care products and cleaning agents recommended and approved by Mercedes-Benz.

Incorrect cleaning and care, as well as aging, can cause the soft-top seams to leak. Have the soft-top seams sealed at a qualified specialist workshop, e.g. at your Mercedes-Benz service center.

- ① Place a suitable cover over the soft top if you plan to leave the vehicle outside for a long period of time.

Notes on care of vehicle parts

⚠ WARNING Risk of entrapment if the windshield wipers are switched on while the windshield is being cleaned

If the windshield wipers are set in motion while you are cleaning the windshield or wiper blades, you can be trapped by the wiper arm.

- ▶ Always switch off the windshield wipers and the ignition before cleaning the windshield or wiper blades.

⚠ WARNING Risk of burns from the tailpipe and tailpipe trims

The exhaust tailpipe and tailpipe trims can become very hot. If you come into contact

with these parts of the vehicle, you could burn yourself.

- ▶ Always be particularly careful around the tailpipe and the tailpipe trims and supervise children especially closely in this area.
- ▶ Allow vehicle parts to cool down before touching them.

Observe the following information:

	Notes on cleaning and care	Avoiding vehicle damage
Wheels/rims	Use water and acid-free wheel cleaners.	<ul style="list-style-type: none"> • Do not use acidic wheel cleaners to remove brake dust. This could damage wheel bolts and brake components. • To avoid corrosion of the brake discs and brakepads, drive the vehicle for a few minutes after cleaning before parking it. The brake discs and brakepads warm up and dry out.
Windows	Clean windows inside and outside with a damp cloth and with a cleaning agent recommended for Mercedes-Benz.	Do not use dry cloths or abrasive or solvent-based cleaning agents to clean the inside of windows.
Wiper blades	Fold out the wiper blades and clean them using a damp cloth.	Do not clean the wiper blades too often.

	Notes on cleaning and care	Avoiding vehicle damage
Exterior lighting	Clean the lenses with a wet sponge and mild cleaning agent, e.g. car shampoo.	Only use cleaning agents or cleaning cloths that are suitable for plastic lenses.
Sensors	Clean the sensors in the front and rear bumper and in the radiator grill with a soft cloth and car shampoo.	When using a power washer, maintain a minimum distance of 11.8 in (30 cm).
Rear view camera and front camera	Use clean water and a soft cloth to clean the camera lens.	Do not use a power washer.
Active aerodynamics profile	<ul style="list-style-type: none"> • Extend the active aerodynamic profile for washing by hand (→ page 156). • Clean the active aerodynamic profile with a soft car sponge and mild cleaning agent, e.g. car shampoo. • Completely retract the active aerodynamic profile after drying (→ page 156). 	Do not use a power washer.
Tailpipes	Clean with a cleaning agent recommended for Mercedes-Benz, especially in the winter and after washing the vehicle.	Do not use acidic cleaning agents.

Notes on care of the interior

⚠ WARNING Risk of injury from plastic parts breaking off after the use of solvent-based care products

Care and cleaning products containing solvents can cause surfaces in the cockpit to become porous.

When the airbags are deployed, plastic parts may break away.

▶ Do not use any care or cleaning products containing solvents to clean the cockpit.

⚠ WARNING Risk of injury or death from bleached seat belts

Bleaching or dyeing seat belts can severely weaken them.

This can, for example, cause seat belts to tear or fail in an accident.

▶ Never bleach or dye seat belts.

Observe the following information:

	Cleaning and care	Avoiding vehicle damage
Seat belts	Clean with lukewarm and soapy water.	<ul style="list-style-type: none"> • Do not use chemical cleaning agents. • Do not dry seat belts by heating them to over 176 °F (80 °C) or exposing them to direct sunlight.
Display	Clean the surface carefully with a microfiber cloth and a suitable display care product (TFT/LCD).	<ul style="list-style-type: none"> • Switch off the display and let it cool down. • Do not use any other cleaning products.
Plastic trim	<ul style="list-style-type: none"> • Clean with a damp microfiber cloth. • For heavy soiling: use care product recommended for Mercedes-Benz. 	<ul style="list-style-type: none"> • Do not attach stickers, films or similar materials. • Do not allow cosmetics, insect repellent or sun cream to come in contact with the plastic trim.

	Cleaning and care	Avoiding vehicle damage
Real wood/trim elements	<ul style="list-style-type: none"> • Clean with a microfiber cloth. • Black piano-lacquer look: clean with a damp cloth and soapy water. • For heavy soiling: use care product recommended for Mercedes-Benz. 	Do not use solvent-based cleaning agents, polishes or waxes.
Headliner	Clean with a brush or dry shampoo.	
Carpet	Use carpet and textile cleaning agents recommended for Mercedes-Benz.	
Genuine leather seat covers	<ul style="list-style-type: none"> • Clean with a damp cloth and then wipe with a dry cloth. • Leather care: use leather care agents that have been recommended for Mercedes-Benz. 	<ul style="list-style-type: none"> • Do not allow the leather to become too damp. • Do not use a microfiber cloth.
DINAMICA seat covers	Clean with a damp cloth.	Do not use a microfiber cloth.
Imitation leather seat covers	Clean with a damp cloth and 1% soapy water.	Do not use a microfiber cloth.
Cloth seat covers	Clean with a damp microfiber cloth and 1% soapy water and allow to dry.	

Emergency

Removing the safety vest

The safety vests are located in front door stowage compartments ①.

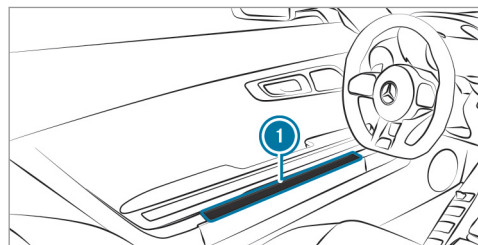

- ▶ **To remove:** pull out the safety vest bag containing the safety vest.
- ▶ Open the safety vest bag and pull out the safety vest.

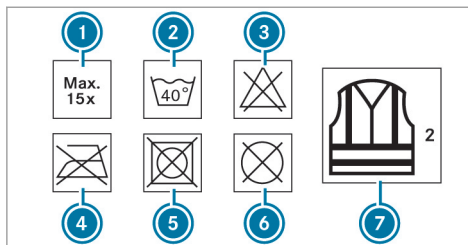

- ① Maximum number of washes
- ② Maximum wash temperature
- ③ Do not bleach
- ④ Do not iron
- ⑤ Do not tumble dry
- ⑥ Do not dry clean
- ⑦ Class 2 safety vest

The requirements defined by the legal standard are only fulfilled if the safety vest is the correct size and is fully closed.

The safety vest must be replaced in the following situations:

- the reflective strips are damaged or dirty

- the maximum permissible number of washes is exceeded
- the fluorescence has faded

Flat tire

Notes on flat tires

⚠ WARNING Risk of accident due to a flat tire

A flat tire severely affects the driving characteristics as well as the steering and braking of the vehicle.

Tires without run-flat characteristics:

- ▶ Do not drive on with a flat tire.
- ▶ Change the flat tire immediately with an emergency spare wheel or spare wheel. Alternatively, consult a qualified specialist workshop.

Tires with run-flat characteristics:

- ▶ Observe the information and warning notes on MOExtended tires (run-flat tires).

In the event of a flat tire, the following options are available depending on your vehicle's equipment:

- **Vehicles with MOExtended tires:** it is possible to continue the journey for a short period of time. Make sure you observe the notes on MOExtended tires (run-flat tires) (→ page 313).
- **Vehicles with a TIREFIT kit:** you can repair the tire so that it is possible to continue the journey for a short period of time. To do this, use the TIREFIT kit (→ page 314).
- **Vehicles with Mercedes me connect:** you can make a call for breakdown assistance in the case of a breakdown (→ page 262).
- **All vehicles:** change the wheel (→ page 354).

Notes on MOExtended tires (run-flat tire)

▲ WARNING Risk of accident when driving in emergency mode

When driving in emergency mode, the handling characteristics are impaired. e.g. when cornering, when accelerating strongly and when braking.

- ▶ Do not exceed the permissible maximum speed for MOExtended tires.
- ▶ Avoid any abrupt steering and driving maneuvers as well as driving over obstacles (curbs, pot holes, off-road). This applies, in particular, to a loaded vehicle.
- ▶ Stop driving in the emergency mode if you notice:
 - banging noise
 - vehicle vibration
 - smoke which smells like rubber
 - continuous ESP® intervention
 - cracks in tire side walls

- ▶ After driving in emergency mode have the rims checked by a qualified specialist workshop with regard to their further use.
- ▶ The defective tire must be replaced in every case.

With MOExtended tires (run-flat tire), you can continue to drive your vehicle even if there is a total loss of pressure in one or more tires. However, the tire affected must not show any clearly visible damage.

You can recognize MOExtended tires by the MOExtended marking which appears on the side wall of the tire.

Vehicles with tire pressure monitoring system: MOExtended tires may only be used in conjunction with an activated tire pressure monitoring system.

If a pressure loss warning message appears in the multifunction display, proceed as follows:

- Check the tire for damage.
- If driving on, observe the following notes.

Driving distance possible in emergency mode after the pressure loss warning:

Load condition	Driving distance possible in emergency mode
Partially laden	50 miles (80 km)
Fully laden	19 miles (30 km)

The driving distance possible in emergency mode may vary depending on the driving style. Observe the maximum permissible speed of 50 mph (80 km/h).

If a tire has gone flat and cannot be replaced with an MOExtended tire, you can use a standard tire as a temporary measure.

TIREFIT kit storage location

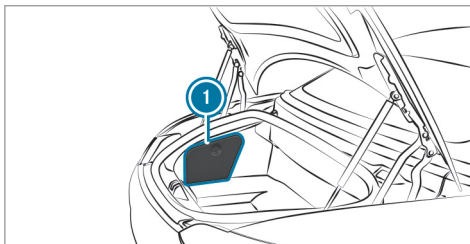

The TIREFIT kit is located on the left side of the trunk in the stowage compartment behind service flap ①.

Using the TIREFIT kit

Requirements:

- Tire sealant bottle and tire inflation compressor available (→ page 314).
- TIREFIT sticker available
- Gloves available

You can use TIREFIT tire sealant to seal perforation damage of up to 0.16 in (4 mm), particularly those in the tire contact surface. You can use TIREFIT in outside temperatures down to -4°F (-20°C).

⚠ WARNING Risk of accident when using tire sealant.

In the following situations, the tire sealant is unable to provide sufficient breakdown assistance, as it is unable to seal the tire properly:

- There are cuts or punctures in the tire larger than those previously mentioned.
 - The wheel rim is damaged.
 - You have driven at a very low tire pressure or on a flat tire.
- ▶ Do not continue driving.
▶ Consult a qualified specialist workshop.

⚠ WARNING Risk of injury and poisoning from tire sealant

The tire sealant is harmful and causes irritation. Do not allow it to come into contact with the skin, eyes or clothing, and do not swallow it. Do not inhale tire sealant fumes. Keep the tire sealant away from children.

If you come into contact with the tire sealant, observe the following:

- ▶ Rinse off the tire sealant from your skin immediately using water.
- ▶ If tire sealant gets into your eyes, thoroughly rinse out the eyes using clean water.
- ▶ If tire sealant has been swallowed, immediately rinse out the mouth thoroughly and drink plenty of water. Do not induce vomiting and seek medical attention immediately.
- ▶ Change out of any clothes contaminated with tire sealant immediately.
- ▶ If allergic reactions occur, seek medical attention immediately.

⚠ NOTE Overheating due to the tire inflation compressor running too long

- ▶ Do not run the tire inflation compressor for longer than ten minutes without interruption.

Comply with the manufacturer's safety notes on the sticker on the tire inflation compressor.

Have the tire sealant bottle replaced in a qualified specialist workshop every five years.

- ▶ Do not remove any foreign objects which have entered the tire.

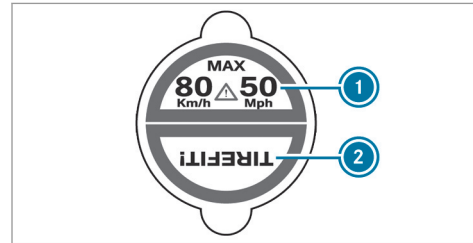

- ▶ Affix part ① of the TIREFIT sticker to the instrument cluster within the driver's field of vision.
- ▶ Affix part ② of the TIREFIT sticker near the valve on the wheel with the faulty tire.

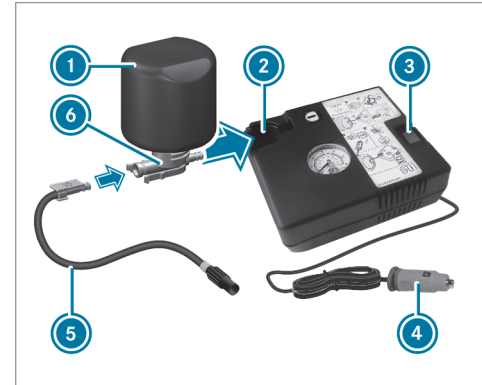

- ▶ Pull plug ④ with the cable and hose ⑤ out of the tire inflation compressor housing.

- ▶ Push the plug of hose ⑤ into flange ⑥ of tire sealant bottle ① until the plug engages.
- ▶ Place tire sealant bottle ① head downwards into recess ② of the tire inflation compressor.

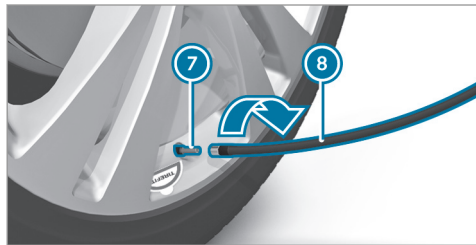

- ▶ Remove the valve cap from valve ⑦ on the faulty tire.
- ▶ Screw filling hose ⑧ onto valve ⑦.
- ▶ Insert plug ④ into a 12 V socket in your vehicle.
- ▶ Switch on the ignition.

- ▶ Press on and off switch ③ on the tire inflation compressor.
The tire inflation compressor is switched on. The tire is inflated. First, tire sealant is pumped into the tire. The pressure may briefly rise to approximately 500 kPa 73 psi ((5 bar)).

Do not switch off the tire inflation compressor during this phase.

- ▶ Let the tire inflation compressor run for a maximum of ten minutes.
The tire should then have attained a tire pressure of at least 200 kPa (29 psi (2.0 bar)).

If tire sealant leaks out, make sure you clean the affected area as quickly as possible. It is preferable to use clean water.

If you get tire sealant on your clothing, have it cleaned as soon as possible with perchloroethylene.

If, after ten minutes, a tire pressure of 200 kPa (29 psi (2.0 bar)) has not been attained:

- ▶ Switch off the tire inflation compressor.
- ▶ Unscrew the filling hose from the valve of the faulty tire.

Please note that tire sealant may leak out when unscrewing the filling hose.

- ▶ Drive forwards or reverse very slowly for approximately 33 ft (10 m).
- ▶ Pump up the tire again.
After a maximum of ten minutes the tire pressure must be at least 200 kPa (29 psi (2.0 bar)).

⚠ WARNING Risk of accident due to the specified tire pressure not being reached

If the specified tire pressure is not reached after the specified time, the tire is too badly damaged. The tire sealant cannot repair the tire in this instance.

Damaged tires and a tire pressure that is too low can significantly impair braking and handling characteristics.

- ▶ Do not continue driving.
- ▶ Consult a qualified specialist workshop.

If, after ten minutes, a tire pressure of 200 kPa (29 psi (2.0 bar)) has been attained:

- ▶ Switch off the tire inflation compressor.
- ▶ Unscrew the filling hose from the valve of the faulty tire.

⚠ WARNING Risk of accident from driving with sealed tires

A tire temporarily sealed with tire sealant impairs driving characteristics and is not suitable for higher speeds.

- ▶ Adapt your driving style accordingly and drive carefully.
- ▶ Do not exceed the maximum speed limit with a tire that has been repaired using tire sealant.

- ▶ Observe the maximum permissible speed for a tire sealed with tire sealant 50 mph (80 km/h).
- ▶ Affix the upper section of the TIREFIT sticker to the instrument cluster in a location where it will be easily seen by the driver.

ℹ NOTE Staining caused by leaking tire sealant

After use, excess tire sealant may leak out from the filling hose.

- ▶ Therefore, place the filling hose in the plastic bag that contained the TIREFIT kit.

🔥 ENVIRONMENTAL NOTE Environmental pollution caused by environmentally irresponsible disposal

Tire sealant contains pollutants.

- ▶ Have the tire sealant bottle disposed of professionally, e.g. at an authorized Mercedes-Benz Center.

- ▶ Stow the tire sealant bottle and the tire inflation compressor.

▶ **Pull away immediately.**

- ▶ Stop driving after approximately ten minutes and check the tire pressure using the tire inflation compressor. The tire pressure must now be at least 130 kPa (19 psi (1.3 bar)).

⚠ WARNING Risk of accident due to the specified tire pressure not being reached

If the specified tire pressure is not reached after a brief drive, the tire is too badly damaged. The tire sealant cannot repair the tire in this instance.

Damaged tires and tire pressure that is too low can significantly impair the braking properties and the handling characteristics.

- ▶ Do not continue driving.
- ▶ Consult a qualified specialist workshop.

In cases such as the one mentioned above, contact an authorized Mercedes-Benz Center. Or

call 1-800-FOR-MERCEdes (in the USA) or 1-800-387-0100 (in Canada).

- ▶ Correct the tire pressure if it is still at least 130 kPa (19 psi (1.3 bar)). See the Tire and Loading Information placard on the B-pillar on the driver's side or the tire pressure table in the fuel filler flap for values.
- ▶ **To increase the tire pressure:** switch on the tire inflation compressor.

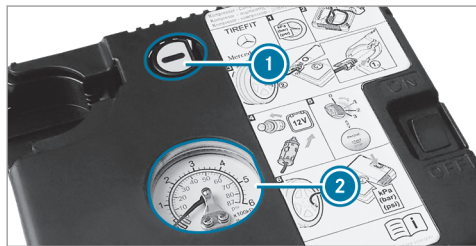

- ▶ **To reduce the tire pressure:** press pressure release button ① next to manometer ②.

- ▶ When the tire pressure is correct, unscrew the filling hose from the valve of the sealed tire.
- ▶ Screw the valve cap onto the valve of the sealed tire.
- ▶ Pull the tire sealant bottle out of the tire inflation compressor. The filling hose stays on the tire sealant bottle.
- ▶ Drive to the nearest qualified specialist workshop and have the tire, tire sealant bottle and filling hose replaced there.

Battery (vehicle)

Notes on the 12 V battery

⚠ WARNING Risk of an accident due to work carried out incorrectly on the battery

Work carried out incorrectly on the battery can, for example, lead to a short circuit. This can lead to function restrictions in safety-rel-

evant systems, for example the lighting system, ABS (anti-lock braking system) or ESP® (Electronic Stability Program). The operating safety of your vehicle may be restricted.

You could lose control of the vehicle in the following situations:

- when braking
- in the event of abrupt steering maneuvers and/or when the vehicle's speed is not adapted to the road conditions
- ▶ In the event of a short circuit or a similar incident, contact a qualified specialist workshop immediately.
- ▶ Do not continue driving.
- ▶ Always have work on the battery carried out at a qualified specialist workshop.

- Further information on ABS (→ page 139)
- Further information on ESP®

For safety reasons, Mercedes-Benz recommends that you only use batteries which have been tested and approved for your vehicle by Mercedes-

Benz. These batteries provide increased impact protection to prevent vehicle occupants from suffering acid burns should the battery be damaged in the event of an accident.

All vehicles except vehicles with a lithium-ion battery

⚠ WARNING Risk of explosion due to electrostatic charge

Electrostatic charge can cause sparks which may ignite the highly flammable gas mixture in the battery.

- ▶ To discharge any electrostatic charge that may have built up, touch the metal vehicle body before handling the battery.

The highly flammable gas mixture is created while the battery is charging and during starting assistance.

⚠ WARNING Danger of chemical burns from the battery acid

Battery acid is caustic.

- ▶ Avoid contact with the skin, eyes or clothing.
- ▶ Do not lean over the battery.
- ▶ Do not inhale battery gases.
- ▶ Keep children away from the battery.
- ▶ Immediately rinse battery acid off thoroughly with plenty of clean water and seek medical attention immediately.

All vehicles

🔥 ENVIRONMENTAL NOTE Environmental damage caused by improper disposal of batteries



Batteries contain pollutants. It is illegal to dispose of them with the household rubbish.



Dispose of batteries in an environmentally responsible manner. Take discharged batteries to a qualified specialist workshop or to a collection point for used batteries.

If you have to disconnect the 12 V battery, contact a qualified specialist workshop.

Comply with safety notes and take protective measures when handling batteries.



Risk of explosion.



Fire, open flames and smoking are prohibited when handling the battery. Avoid creating sparks.



Electrolyte or battery acid is corrosive. Avoid contact with the skin, eyes or clothing. Wear suitable protective clothing, in particular gloves, an

apron and a face mask. Immediately rinse electrolyte or acid splashes off with clean water. Consult a doctor if necessary.

Wear safety glasses.



Keep children away.



Observe this Operator's Manual.



Observe the following if you do not intend to use the vehicle over an extended period of time:

- Activate standby mode.
- Alternatively: connect the battery to a battery charger approved by Mercedes-Benz or consult a qualified specialist workshop to disconnect the battery.

Notes on starting assistance and on charging the 12 V battery

Vehicles with a lithium-ion battery

When charging the battery and during starting assistance, always use the jump-start connection point in the engine compartment.

! **NOTE** Damaging the battery through overvoltage

When charging using a battery charger without a maximum charging voltage, the battery or the vehicle electronics may be damaged.

- ▶ Only use battery chargers with a maximum charging voltage of 14.8 V.

All other vehicles

When charging the battery and during starting assistance, always use the jump-start connection point in the engine compartment.

! **NOTE** Damaging the battery through overvoltage

When charging using a battery charger without a maximum charging voltage, the battery or the vehicle electronics may be damaged.

- ▶ Only use battery chargers with a maximum charging voltage of 14.8 V.

! **WARNING** Risk of explosion from hydrogen gas igniting

A battery generates hydrogen gas during the charging process. If there is a short circuit or sparks start to form, there is a danger of the hydrogen gas igniting.

- ▶ Make sure that the positive terminal of the connected battery does not come into contact with vehicle parts.
- ▶ Never place metal objects or tools on a battery.
- ▶ When connecting and disconnecting the battery, you must observe the described order for the battery clamps.

- ▶ When giving starting assistance, always make sure that you only connect battery terminals with identical polarity.
- ▶ During starting assistance, you must observe the described order for connecting and disconnecting the jumper cables.
- ▶ Do not connect or disconnect the battery clamps while the engine is running.

⚠ WARNING Risk of explosion during charging process and starting assistance

During the charging process and starting assistance, the battery may release an explosive gas mixture.

- ▶ Avoid fire, open flames, creating sparks and smoking.
- ▶ Make sure that there is sufficient ventilation during the charging process and during starting assistance.
- ▶ Do not lean over a battery.

⚠ WARNING Risk of explosion from a frozen battery

A discharged battery may freeze at temperatures slightly above or below freezing point.

During starting assistance or battery charging, battery gas may be released.

- ▶ Always thaw a frozen battery out first before charging it or performing starting assistance.

If the indicator/warning lamps in the instrument cluster do not light up at low temperatures, it is very likely that the discharged battery has frozen. In this case you may neither jump-start the vehicle nor charge the battery.

The service life of a battery that has been thawed may be dramatically shortened. The starting characteristics may be impaired, especially at low temperatures.

It is recommended that you have a thawed battery checked at a qualified specialist workshop.

All vehicles

! **NOTE** Damage caused by numerous or extended attempts to start the engine

Numerous or extended attempts to start the engine may damage the catalytic converter due to non-combusted fuel.

- ▶ Avoid numerous and extended attempts to start the engine.

Observe the following points during starting assistance and when charging the battery:

- Only use undamaged jumper cables/charging cables with a sufficient cross-section and insulated terminal clamps.
- Non-insulated parts of the terminal clamps must not come into contact with other metal parts while the jumper cable/charging cable is connected to the battery/jump-start connection point.
- The jumper cable/charging cable must not come into contact with any parts which may move when the engine is running.

- Always make sure that neither you nor the battery is electrostatically charged.
- Keep away from fire and open flames.
- Do not lean over the battery.

Observe the additional following points when charging the battery:

- Only use battery chargers tested and approved for Mercedes-Benz.
- Read the battery charger's operating instructions before charging the battery.

Observe the additional following points during starting assistance:

- Starting assistance may only be provided using batteries with a nominal voltage of 12 V.
- The vehicles must not touch.
- **Gasoline engines:** Only accept starting assistance if the engine and exhaust system are cold.

Starting assistance and charging the 12 V battery

Requirements:

- The vehicle is secured with the electric parking brake.
- **Vehicles with automatic transmission:** The transmission is in position **P**.
- The ignition and all electrical consumers are switched off.
- The hood is open.

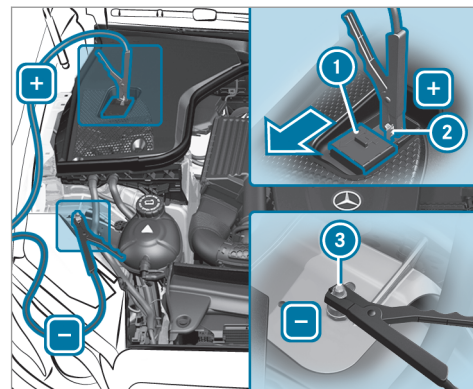

Example: engine compartment

- ▶ Slide cover ① of positive clamp ② on the jump-starting connection point in the direction of the arrow.
- ▶ Connect positive clamp ② on your vehicle to the positive pole of the donor battery using the jumper cable/charging cable. Always

begin with positive clamp ② on your own vehicle first.

- ▶ **During starting assistance:** start the engine of the donor vehicle and run at idle speed.
- ▶ Connect the negative pole of the donor battery and ground point ③ of your own vehicle by using the jumper cable/charging cable. Begin with the donor battery first.
- ▶ **During starting assistance:** start the engine of your own vehicle.
- ▶ **During the charging process:** start the charging process.
- ▶ **During starting assistance:** let the engines run for several minutes.
- ▶ **During starting assistance:** before disconnecting the jumper cable, switch on an electrical consumer in your own vehicle, e.g. the rear window heater or lighting.

When the starting assistance/charging process is complete, perform the following steps:

- ▶ First, remove the jumper cable/charging cable from ground point ③ and the negative pole of the donor battery, then from positive clamp ② and the positive pole of the donor battery. Begin each time with the contacts on your own vehicle first.
- ▶ After removing the jumper cable/charging cable, close cover ① of positive clamp ②.

Further information can be obtained at a qualified specialist workshop.

Replacing the 12 V battery

- ▶ Observe the notes on the 12 V battery (→ page 318).

Mercedes-Benz recommends that you have the 12 V battery replaced at a qualified specialist workshop, e.g. at an authorized Mercedes-Benz Center.

Observe the following notes if you want to replace the battery yourself:

- Always replace a faulty battery with a battery which meets the specific vehicle requirements.

The vehicle is equipped with an AGM technology battery (Absorbent Glass Mat) or a lithium-ion battery. Full vehicle functionality is only guaranteed with an AGM battery or lithium-ion battery. For safety reasons, Mercedes-Benz recommends that you only use batteries which have been tested and approved for your vehicle by Mercedes-Benz.

- Carry over detachable parts, such as vent hoses, elbow fitting or terminal covers from the battery being replaced.
- Make sure that the vent hose is always connected to the original opening on the side of the battery.

Install any existing or supplied cell caps.

Otherwise, gases or battery acid could escape.

- Make sure that detachable parts are reconnected in the same way.

Tow starting or towing away

Permitted towing methods

Mercedes-Benz recommends transporting your vehicle in the case of a breakdown, rather than towing it away.

For towing, use a tow rope or tow bar with both axles on the ground. Do not use tow bar systems.

Permitted towing methods



Both axles on the ground

Yes, maximum 31 miles (50 km) at 31 mph (50 km/h)



Front axle raised

No



Rear axle raised

No

⚠ WARNING Risk of accident when towing with steering wheel lock

You will no longer be able to steer the vehicle if the steering wheel lock is engaged.

- ▶ Always switch on the ignition when towing the vehicle with a tow cable or a tow bar.

! NOTE Damage to the vehicle due to towing away incorrectly

- ▶ Observe the instructions and notes on towing away.

Towing the vehicle with both axles on the ground

- ▶ Observe the notes on the permitted towing methods (→ page 324).
- ▶ Make sure that the battery is connected and charged.

Observe the following points when the battery is discharged:

- The engine cannot be started
 - The electric parking brake cannot be released or applied
 - **Vehicles with automatic transmission:** The automatic transmission cannot be shifted to position **N** or **P**.
- i** **Vehicles with automatic transmission:** If the automatic transmission cannot be shifted to position **N**, or the multifunction display in the instrument cluster does not show anything, have the vehicle transported away (→ page 326). A towing vehicle with lifting equipment is required for vehicle transportation.

! **NOTE** Damage due to towing away at excessively high speeds or over long distances

The drivetrain could be damaged when towing at excessively high speeds or over long distances.

- ▶ A towing speed of 30 mph (50 km/h) must not be exceeded.
- ▶ A towing distance of 30 miles (50 km) must not be exceeded.

! **WARNING** Risk of accident when towing a vehicle which is too heavy

If the vehicle being tow-started or towed away is heavier than the permissible gross mass of your vehicle, the following situations can occur:

- The towing eye may become detached.
 - The vehicle/trailer combination may swerve or even overturn.
- ▶ If another vehicle is tow-started or towed away, its weight must not exceed

the permissible gross mass of your own vehicle.

If a vehicle must be tow-started or towed away, its permissible gross weight must not exceed the permissible gross weight of the towing vehicle.

- ▶ Information on the permissible gross mass of the vehicle can be found on the vehicle identification plate (→ page 360).
- ▶ **Vehicles with automatic transmission:** Do not open the driver's door or front passenger door, otherwise the automatic transmission automatically shifts to position **P**.
- ▶ Install the towing eye (→ page 327).
- ▶ Fasten the tow bar.

! **NOTE** Damage due to incorrect connection of the tow bar

- ▶ Only connect the tow rope or tow bar to the towing eyes.

- ▶ Deactivate the automatic locking mechanism (→ page 61).

▶ Do not activate the HOLD function.

▶ Deactivate Active Brake Assist
(→ page 145).

▶ **Vehicles with automatic transmission:**

Shift the automatic transmission to position **[N]**.

▶ Release the electric parking brake.

⚠ WARNING Risk of accident due to limited safety-related functions during the towing process

Safety-related functions are limited or no longer available in the following situations:

- the ignition is switched off.
- the brake system or power steering system is malfunctioning.
- the energy supply or the on-board electrical system is malfunctioning.

When your vehicle is then towed away, significantly more effort may be required to steer and brake than is normally required.

▶ Use a tow bar.

▶ Make sure that the steering wheel can move freely, before towing the vehicle away.

! **NOTE** Damage due to excessive tractive power

If you pull away sharply, the tractive power may be too high and the vehicles could be damaged.

▶ Pull away slowly and smoothly.

Loading the vehicle for transport

▶ Observe the notes on towing away
(→ page 325).

▶ Connect the tow bar to the towing eye in order to load the vehicle.

▶ Shift the automatic transmission to position **[N]**.

i The automatic transmission may be locked in position **[P]** in the event of damage to the electrics. To shift to **[N]**, provide the on-

board electrical system with power
(→ page 322).

▶ Load the vehicle onto the transporter.

▶ Shift the automatic transmission to position **[P]**.

▶ Use the electric parking brake to secure the vehicle against rolling away.

▶ Only secure the vehicle by the wheels.

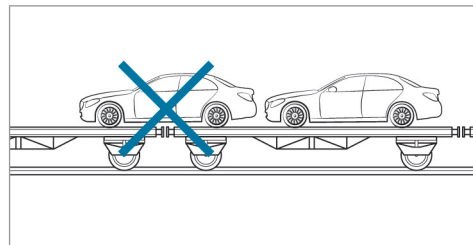

▶ Make sure that the front and rear axles come to rest on the same transportation vehicle.

! **NOTE** Damage to the drivetrain due to incorrect positioning

- ▶ Do not position the vehicle above the connection point of the transport vehicle.

Towing eye storage location

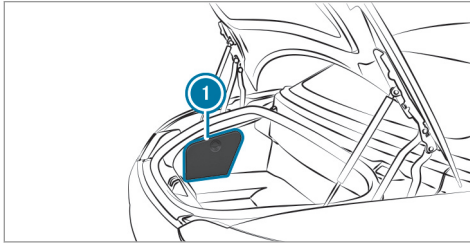

The towing eye is located on the left side of the trunk in the storage compartment behind service flap ①.

Installing the towing eye

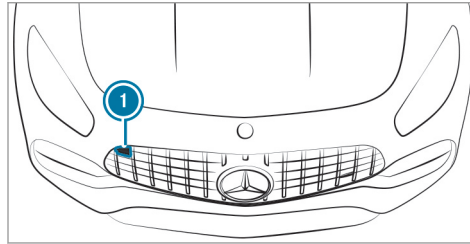

- ▶ Pull out cover ①.
- ▶ Screw in the towing eye clockwise as far as it will go and tighten.
- ① Make sure that cover ① engages in the bumper when you remove the towing eye.

! **NOTE** Damage due to incorrect use of the towing eye

When a towing eye is used to recover a vehicle, the vehicle may be damaged in the process.

- ▶ Only use the towing eye to tow away or tow start the vehicle.

Tow-starting the vehicle (emergency engine start)

! **NOTE** Damage to the automatic transmission due to tow starting

The automatic transmission may be damaged in the process of tow starting vehicles with automatic transmission.

- ▶ Vehicles with automatic transmission must not be tow started.
- ▶ Vehicles with automatic transmission must not be tow-started.

Electrical fuses

Notes on electrical fuses

⚠ WARNING Risk of accident and injury due to overloaded lines

If you manipulate or bridge a faulty fuse or if you replace it with a fuse with a higher amperage, the electric line could be overloaded.

This could result in a fire.

- ▶ Always replace faulty fuses with specified new fuses containing the correct amperage.

! NOTE Damage due to incorrect fuses

Electrical components or systems may be damaged by incorrect fuses, or their functionality may be significantly impaired.

- ▶ Only use fuses that have been approved by Mercedes-Benz and which have the correct fuse rating.

Blown fuses must be replaced with fuses of the same rating, which you can recognize by the color and fuse rating. The fuse ratings and further information to be observed are listed in the fuse assignment diagram.

Fuse assignment diagram: on the fuse box in the trunk (→ page 329).

! NOTE Damage or malfunctions caused by moisture

Moisture may cause damage to the electrical system or cause it to malfunction.

- ▶ When the fuse box is open, make sure that no moisture can enter the fuse box.
- ▶ When closing the fuse box, make sure that the seal of the lid is positioned correctly on the fuse box.

If the newly inserted fuse also blows, have the cause traced and rectified at a qualified specialist workshop.

Ensure the following before replacing a fuse:

- The vehicle is secured against rolling away.

- All electrical consumers are switched off.
- The ignition is switched off.

The electrical fuses are located in various fuse boxes:

- Fuse box in the front passenger footwell (→ page 328)
- Fuse box in the trunk on the left-hand side of the vehicle, when viewed in the direction of travel (→ page 329)

Opening and closing the fuse box in the front passenger footwell

Observe the notes on electrical fuses (→ page 328).

Opening

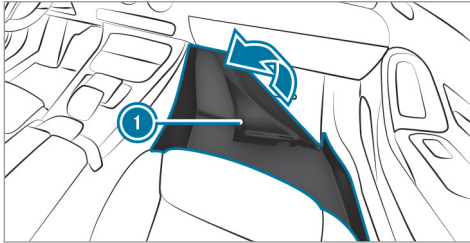

- ▶ Remove carpet ① over the footrest.

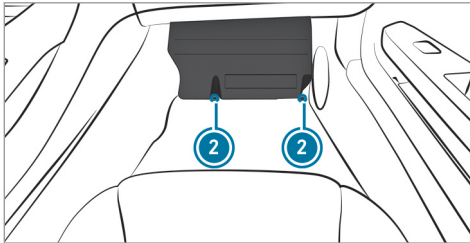

- ▶ Loosen screws ② on the floor panel and remove the floor panel.

Closing

- ▶ Install the floor panel again.
- ▶ Tighten screws ②.
- ▶ Position the carpet back in place and press down firmly.

Opening and closing the fuse box in the trunk

Observe the notes on electrical fuses
(→ page 328).

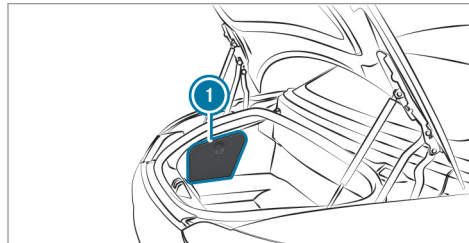

- ▶ Turn the fastener on service flap ① counter-clockwise.
- ▶ Open the service flap.

The fuse assignment diagram is in a recess on the side of the fuse box.

Notes on noise or unusual handling characteristics

While driving, pay attention to vibrations, noises and unusual handling characteristics, e.g. pulling to one side. This may indicate that the wheels or tires are damaged. If you suspect that a tire is defective, reduce your speed immediately. Stop the vehicle as soon as possible to check the wheels and tires for damage. Hidden tire damage could also be causing the unusual handling characteristics. If you find no signs of damage, have the tires and wheels checked at a qualified specialist workshop.

Notes on regularly inspecting wheels and tires

⚠ WARNING Risk of accident from damaged tires

Damaged tires can cause tire pressure loss. As a result, you could lose control of your vehicle.

▶ Check the tires regularly for signs of damage and replace any damaged tires immediately.

⚠ WARNING Risk of aquaplaning due to insufficient tire tread

Insufficient tire tread will result in reduced tire grip. The tire tread is no longer able to dissipate water.

This means that in heavy rain or slush the risk of hydroplaning is increased, in particular if vehicle speed is not adapted to suit the conditions.

If the tire pressure is too high or too low, tires may exhibit different levels of wear at different locations on the tire contact surface.

▶ Thus, you should regularly check the tread depth and the condition of the tire contact surface across the entire width of all tires.

Minimum tread depth for:

- Summer tires: $\frac{1}{8}$ in (3 mm)
- M+S tires: $\frac{1}{8}$ in (4 mm)

▶ For safety reasons, replace the tires before the legally prescribed limit for the minimum tread depth is reached.

Carry out the following checks on all wheels regularly, at least once a month or as required, e.g. prior to a long journey or driving off-road:

- Check the tire pressure (→ page 331).
- Visually inspect tires and wheels for damage.
- Check the valve caps.

The valves must be protected against moisture and dirt by the valve caps approved especially for your vehicle by Mercedes-Benz.

- Visual check of the tire tread depth and the tire contact surface across the entire width. The minimum tread depth for summer tires is $\frac{1}{8}$ in (3 mm) and for winter tires $\frac{1}{8}$ in (4 mm).

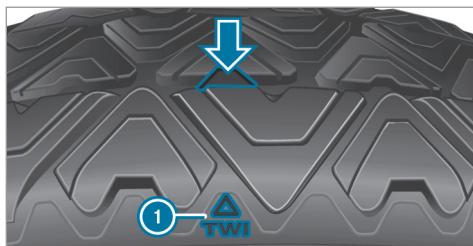

Six marks ① show where the bar indicators (arrow) are integrated into the tire tread. They are visible once a tread depth of approximately $\frac{1}{16}$ in (1.6 mm) has been reached.

Notes on snow chains

⚠ WARNING Risk of accident due to incorrect mounting of snow chains

If you have mounted snow chains to the front wheels, the snow chains may drag against the vehicle body or chassis components.

This could cause damage to the vehicle or the tires.

- ▶ Never mount snow chains on the front wheels.
- ▶ Only mount snow chains on the rear wheels in pairs.

⚠ NOTE Damage to the wheel trim from mounted snow chains

If snow chains are mounted to steel wheels, the wheel trims can be damaged.

- ▶ Remove the wheel trims of steel wheels before mounting snow chains.

Observe the following notes when using snow chains:

- Snow chains are only permissible for certain wheel/tire combinations. You can obtain information about this from an authorized Mercedes-Benz Center.
- For safety reasons, only use snow chains that have been specifically approved for your

vehicle by Mercedes-Benz, or snow chains with the same quality standard.

- If snow chains are installed, the maximum permissible speed is 30 mph (50 km/h).
 - **Vehicles with level control:** If snow chains are installed, only drive at raised vehicle level.
- ① You can deactivate ESP® to pull away (→ page 142). This allows the wheels to spin, achieving an increased driving force.

Tire pressure

Notes on tire pressure

⚠ WARNING Risk of accident due to insufficient or excessive tire pressure

Underinflated or overinflated tires pose the following risks:

- The tires may burst, especially as the load and vehicle speed increase.

- The tires may wear excessively and/or unevenly, which may greatly impair tire traction.
- The driving characteristics, as well as steering and braking, may be greatly impaired.
- ▶ Comply with the recommended tire pressure and check the tire pressure of all tires including the spare wheel regularly:
 - at least once a month
 - when the load changes
 - before embarking on a longer journey
 - if operating conditions change, e.g. off-road driving
- ▶ Adjust the tire pressure as necessary.

Tire pressure which is too high or too low can:

- Shorten the service life of the tires.
- Cause increased tire damage.
- Adversely affect driving characteristics and thus driving safety, e.g. due to hydroplaning.

▲ WARNING Risk of an accident due to insufficient tire pressure

Tires with pressure that is too low can overheat and burst as a result.

In addition, they also suffer from excessive and/or irregular wear, which can significantly impair the braking properties and the handling characteristics.

- ▶ Avoid excessively low tire pressures in all the tires, including the spare wheel.

Tire pressure which is too low can cause:

- Tire defects as a result of overheating.
- Impaired handling characteristics.
- Irregular wear.
- Increased fuel consumption.

▲ WARNING Risk of accident from excessive tire pressure

Tires with excessively high pressure can burst because they are damaged more easily by highway fill, pot holes etc.

In addition, they also suffer from irregular wear, which can significantly impair the braking properties and the handling characteristics.

- ▶ Avoid excessively high tire pressures in all the tires, including the spare wheel.

Tire pressure which is too high can cause:

- Increased braking distance.
- Impaired handling characteristics.
- Irregular wear.
- Impaired driving comfort.
- Susceptibility to damage.

▲ WARNING Risk of accident caused by repeated drop in tire pressure

If the tire pressure drops repeatedly, the wheel, valve or tire may be damaged.

Insufficient tire pressure can cause the tires to burst.

- ▶ Inspect the tire for signs of foreign objects.

- ▶ Check whether the wheel or valve has a leak.
- ▶ If you are unable to rectify the damage, contact a qualified specialist workshop.

You can find information on tire pressure for the vehicle's factory-installed tires on the following labels:

- Tire and Loading Information placard on the B-pillar of your vehicle (→ page 338).
- Tire pressure table on the inside of the fuel filler flap (→ page 333).

Observe the maximum tire pressure (→ page 344).

Use a suitable pressure gauge to check the tire pressure. The outer appearance of a tire does not permit any reliable conclusion about the tire pressure.

Vehicles with a tire pressure monitoring system: You can also check the tire pressure using the on-board computer.

Only correct tire pressure when the tires are cold. Conditions for cold tires:

- The vehicle has been parked with the tires out of direct sunlight for at least three hours.
- The vehicle has traveled less than 1 mile (1.6 km).

A rise in the tire temperature of 18 °F (10 °C) increases the tire pressure by approx. 10 kPa (0.1 bar/1.5 psi). Take this into account when checking the tire pressure of warm tires.

The tire pressure recommended for increased load/speed in the tire pressure table can affect the ride comfort.

⚠ WARNING Risk of accident due to unsuitable accessories on tire valve

If you mount unsuitable accessories onto tire valves, the tire valves may be overloaded and malfunction, which can cause a loss of tire pressure. Aftermarket tire pressure monitoring systems will cause the tire valve to remain open, depending on the design. This can also result in a loss of tire pressure.

- ▶ Only screw standard valve caps or valve caps specifically approved by Mercedes-Benz for your vehicle onto the tire valve.

Tire pressure table

The tire pressure table is on the inside of the fuel filler flap.

- ① The data shown in the images is example data.

COLD TIRE PRESSURE			
normal load	30 psi	30 psi	30 psi
maximum load	35 psi	35 psi	35 psi
Warm tires up to: + 4 psi			

The tire pressure table shows the recommended tire pressure for all tires approved for this vehicle. The recommended tire pressures apply for

334 Wheels and tires

cold tires under various operating conditions, i.e. loading and/or speed of the vehicle.

If one or more tire sizes precede a tire pressure, the tire pressure information following is only valid for those tire sizes.

The load conditions "partially laden" and "fully laden" are defined in the table for different numbers of passengers and amounts of luggage. The actual number of seats may differ from this.

		kPa	psi	kPa	psi
R18	[Icons]				
R19	[Icons]				
M+S	[Icons]				

Some tire pressure tables only show the rim diameter instead of the complete tire size, e.g. **R18**. The rim diameter is part of the tire size and can be found on the tire side wall (→ page 345).

Be sure to also observe the following further related subjects:

- Notes on tire pressure (→ page 331)
- Tire and Loading Information placard (→ page 338)
- Maximum tire pressure (→ page 344)

Checking tire pressures manually

- ▶ Read the tire pressure for the current operating conditions from the Tire and Loading Information placard or the tire pressure table. Observe the notes on tire pressure.
- ▶ Remove the valve cap of the tire to be checked.
- ▶ Press the tire pressure gauge securely onto the valve.
- ▶ Read the tire pressure.

- ▶ If the tire pressure is lower than the recommended value, increase the tire pressure to the recommended value.
- ▶ If the tire pressure is higher than the recommended value, release air. To do so, press down the metal pin in the valve, e.g. using the tip of a pen for example. Then check the tire pressure again using the tire pressure gauge.
- ▶ Screw the valve cap onto the valve.

Further related subjects:

- Notes on tire pressure (→ page 331)
- Tire pressure table (→ page 333)
- Tire and Loading Information placard (→ page 338)

Tire pressure monitoring system

Function of the tire pressure monitoring system

▲ DANGER Risk of accident due to incorrect tire pressure

Every tire, including the spare (if provided), should be checked when cold at least once a month and inflated to the pressure recommended by the vehicle manufacturer (see Tire and Loading Information placard on the B-pillar on the driver's side or the tire pressure label on the inside of the fuel filler flap of your vehicle). If your vehicle has tires of a different size than the size indicated on the Tire and Loading Information placard or the tire pressure table, you need to determine the proper tire pressure for those tires.

As an added safety feature, your vehicle has been equipped with a tire pressure monitoring system (TPMS) that illuminates a low tire pressure indicator lamp when one or more of your tires are significantly underinflated. Accordingly, if the low tire pressure indicator

lamp lights up, you should stop and check your tires as soon as possible, and inflate them to the proper pressure. Driving on a significantly underinflated tire causes the tire to overheat and can lead to tire failure. Underinflation also increases fuel consumption and reduces tire tread life, and may affect the vehicle's handling and braking ability. Please note that the TPMS is not a substitute for proper tire maintenance, and it is the driver's responsibility to maintain correct tire pressure, even if underinflation has not reached the level to trigger illumination of the TPMS low tire pressure indicator lamp.

Your vehicle has also been equipped with a TPMS malfunction indicator to indicate when the system is not operating properly. The TPMS malfunction indicator is combined with the low tire pressure indicator lamp. When the system detects a malfunction, the indicator lamp will flash for approximately a minute and then remain continuously illuminated. This sequence will continue upon subsequent vehicle start-ups as long as the malfunction exists.

When the malfunction indicator is illuminated, the system may not be able to detect or signal low tire pressure as intended. TPMS malfunctions may occur for a variety of reasons, including the installation of incompatible replacement or alternate tires or wheels on the vehicle that prevent the TPMS from functioning properly.

Always check the TPMS malfunction warning lamp after replacing one or more tires or wheels on your vehicle to ensure that the replacement or alternate tires and wheels allow the TPMS to continue to function properly.

The system checks the tire pressure and the tire temperature of the tires installed on the vehicle by means of a tire pressure sensor.

New tire pressure sensors, e.g. in winter tires, are automatically taught-in during the first journey they are used.

The tire pressure and the tire temperature appear in the multifunction display (→ page 336).

If there is a substantial pressure loss or if the tire temperature is excessive, you will be warned in the following ways:

- via display messages (→ page 400)
- via the  warning lamp in the instrument cluster (→ page 429)

The tire pressure monitoring system is only an aid. It is the driver's responsibility to set the tire pressure to the recommended cold tire pressure suitable for the operating situation. Set the tire pressure for cold tires using a tire pressure gauge. Note that the correct tire pressure for the current operating situation must first be taught-in to the tire pressure monitoring system.

In most cases, the tire pressure monitoring system will automatically update the new reference values after you have changed the tire pressure. You can, however, also update the reference values by restarting the tire pressure monitoring system manually (→ page 337).

System limits

The system may be impaired or may not function in the following situations:

- the tire pressure has been set incorrectly
- there is a sudden pressure loss caused, for example, by a foreign object penetrating the tire
- there is a malfunction caused by another radio signal source

Make sure to observe the following further related subject:

- notes on tire pressure (→ page 331)

Checking the tire pressure with the tire pressure monitoring system Requirements:

- The ignition is switched on.

On-board computer:

 [Service](#)  [Tires](#)

One of the following displays appears:

- Current tire pressure and tire temperature of the individual wheels:

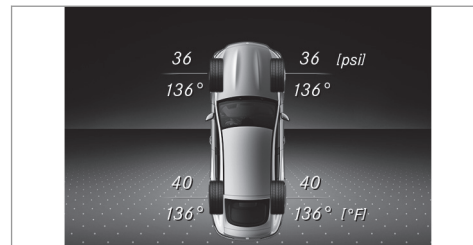

- **Tire pressure will be displayed after driving a few minutes**
 - **Tire Pressure Monitor Active:** the teach-in process of the system is not yet complete. The tire pressures are already being monitored.
-  Compare the tire pressure with the recommended tire pressure for the current operating condition (→ page 333). Observe the notes on tire temperature (→ page 331).

- ⓘ The values displayed in the multifunction display may deviate from those of the tire pressure gauge as they refer to sea level. At high altitudes, the tire pressure value indicated by a pressure gauge are higher than those shown by the on-board computer. In this case, do not reduce the tire pressure.

Make sure to observe the following further related subject:

- Notes on tire pressure (→ page 331)

Restarting the tire pressure monitoring system

Requirements:

- The recommended tire pressure is correctly set for the respective operating status on each of the four wheels (→ page 331).

Restart the tire pressure monitoring system in the following situations:

- The tire pressure has changed.
- The wheels or tires have been changed or newly installed.

On-board computer:

→ Service → Tires

- ▶ Swipe downwards on Touch Control on the left-hand side of the steering wheel. The **Use Current Pressures as New Reference Values?** message is shown in the multifunction display.
- ▶ To begin restart, press Touch Control on the left-hand side of the steering wheel. The **Tire Press. Monitor Restarted** message is shown in the multifunction display. Current warning messages are deleted and the yellow  warning lamp goes out. After you have been driving for a few minutes, the system checks whether the current tire pressures are within the specified range. The current tire pressures are then accepted as reference values and monitored.

Make sure to observe the following further related subject:

- Notes on tire pressure (→ page 331)

Radio-equipment approval of the tire pressure monitoring system

Radio equipment approval numbers

Country	Radio type approval number
Canada	IC: 2546A-GG4T IC: 2546A-DG6W2D4 IC: 2546A-MC34MA4 Le présent appareil est conforme aux CNR d'Industrie Canada applicables aux appareils radio exempts de licence. L'exploitation est autorisée aux deux conditions suivantes: (1) l'appareil ne doit pas produire de brouillage, et (2) l'utilisateur de l'appareil doit accepter tout brouillage radioélectrique subi, même si le brouillage est susceptible d'en compromettre le fonctionnement.

Country	Radio type approval number
USA	FCC ID: MRXGG4T FCC ID: MRXDG6W2D4 FCC ID: MRXMC34MA4 This device complies with Part 15 of the FCC Rules. Operation is subject to the following two conditions: (1) This device may not cause harmful interference, and (2) This device must accept any interference received, including interference that may cause undesired operation.

Loading the vehicle

Notes on Tire and Loading Information placard

⚠ WARNING Risk of accident from overloaded tires

Overloaded tires may overheat and burst as a consequence. Overloaded tires can also impair the steering and handling characteristics and lead to brake failure.

- ▶ Observe the load-bearing capacity of the tires.
- ▶ The load-bearing capacity must be at least half the gross axle weight rating of the vehicle.
- ▶ Never overload the tires by exceeding the maximum load.

The Tire and Loading Information placard is on the B-pillar on the driver's side of the vehicle.

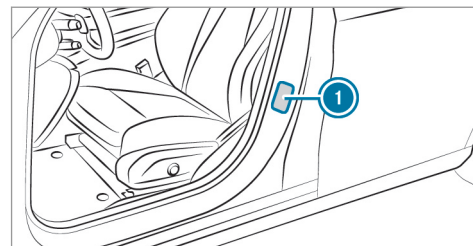

① Tire and Loading Information placard

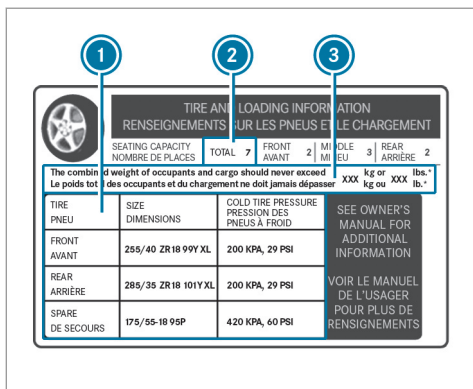

i The data shown in the illustration is example data.

The Tire and Loading Information placard shows:

- Maximum number of seats **2** according to the maximum number of people permitted to travel in the vehicle.
- Maximum permissible load **3** comprises the gross weight of all vehicle occupants, load and luggage.

- Recommended tire pressures **1** for cold tires. The recommended tire pressures are valid for the maximum permissible load and up to the maximum permissible vehicle speed.

Please also note:

- Information on permissible weights and loads on the vehicle identification plate (→ page 360).
- Information on tire pressure in the tire pressure table (→ page 333).

Further related subjects:

- Determining the maximum permissible load (→ page 339)
- Notes on tire pressure (→ page 331).

Determining the maximum permissible load

The following steps have been developed as required of all manufacturers under Title 49, Code of U.S. Federal Regulations, Part 575 pursuant to the "National Traffic and Motor Vehicle Safety Act of 1966".

▶ Step 1: locate the statement "The combined weight of occupants and cargo should never exceed XXX kg or XXX lbs." ("The combined weight of occupants and cargo should never exceed XXX kg or XXX lbs.") on your vehicle's Tire and Loading Information placard.

▶ Step 2: determine the combined weight of the driver and passengers that will be traveling in your vehicle.

▶ Step 3: subtract the combined weight of the driver and passengers from XXX kg or XXX lbs.

▶ Step 4: the resulting figure equals the permissible cargo and luggage load capacity. For example: If "XXX" equals 1400 lbs and there are five occupants in your vehicle with a weight of 150 lbs each, the maximum cargo and luggage load capacity is 650 lbs (1,400 - 750 (5 x 150) = 650 lbs).

▶ Step 5: determine the combined weight of luggage and cargo that the vehicle will be carrying. For safety reasons, this weight may not safely exceed the available cargo and luggage load capacity calculated in step 4.

340 Wheels and tires

Even if you have calculated the total load carefully, you should still make sure that the maximum permissible gross mass and the maximum gross axle weight rating of your vehicle are not exceeded. Details can be found on the vehicle identification plate.

- ▶ Have your loaded vehicle – including driver, occupants and load – weighed on a vehicle weighbridge.
The measured values may not exceed the maximum permissible values stated on the vehicle identification plate.

Further related subjects:

- Calculation example for determining the maximum load (→ page 340)
- Tire and Loading Information placard (→ page 338)
- Tire pressure table (→ page 333)
- Vehicle identification plate

Calculation example for determining the maximum load

The following table shows examples of how to calculate total and load capacities with varying

seating configurations and different numbers and sizes of occupants. The following examples use a maximum load of 1500 lbs (680 kg). **This is for illustration purposes only.** Make sure you are using the actual load limit for your vehicle stated on your vehicle's Tire and Loading Information placard (→ page 338).

The higher the weight of all the occupants, the smaller the maximum load for luggage.

Step 1

	Example 1	Example 2
Combined maximum weight of occupants and load (data from the Tire and Loading Information placard)	1500 lbs (680 kg)	1500 lbs (680 kg)

Step 2

	Example 1	Example 2
Number of people in the vehicle (driver and occupants)	5	1
Distribution of the occupants	Front: 2 Rear: 3	Front: 1
Weight of occupants	Occupant 1: 150 lbs (68 kg) Occupant 2: 180 lbs (82 kg) Occupant 3: 160 lbs (73 kg) Occupant 4: 140 lbs (63 kg) Occupant 5: 120 lbs (54 kg)	Occupant 1: 200 lbs (91 kg)
Total weight of all occupants	750 lbs (340 kg)	200 lbs (91 kg)

Step 3

	Example 1	Example 2
Permissible load (maximum gross vehicle weight rating from the Tire and Loading Information placard minus the gross weight of all occupants)	1500 lbs (680 kg) - 750 lbs (340 kg) = 750 lbs (340 kg)	1500 lbs (680 kg) - 200 lbs (91 kg) = 1300 lbs (589 kg)

Tire labeling

Overview of tire labeling

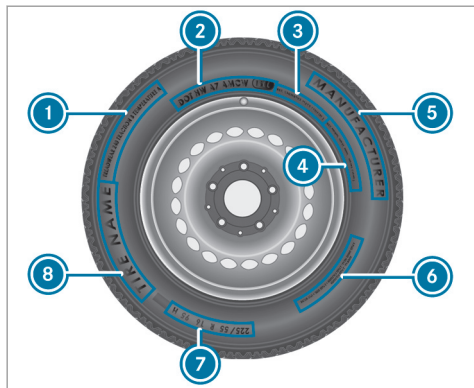

- ① Uniform Tire Quality Grading Standard (→ page 342)
- ② DOT, Tire Identification Number (→ page 343)
- ③ Maximum tire load (→ page 344)
- ④ Maximum tire pressure (→ page 344)

- ⑤ Manufacturer
- ⑥ Characteristics of the tire (→ page 345)
- ⑦ Tire size designation, load-bearing capacity, speed rating and load index (→ page 345)
- ⑧ Tire name
- ⓘ The data shown in the image is example data.

Tire Quality Grading

In accordance with the US Department of Transportation's "Uniform Tire Quality Grading Standards", tire manufacturers are required to grade their tires on the basis of the following three performance factors:

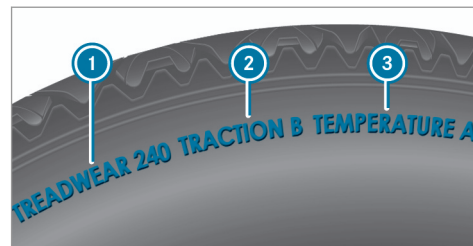

- ① Tread wear grade
- ② Traction grade
- ③ Temperature grade
- ⓘ The data shown in the image is example data.
- ⓘ The classification is not legally stipulated for Canada, but it is generally stated.

Tread wear grade

The tread wear grade is a comparative rating based on the wear rate of the tire when tested under controlled conditions on a specified test track of the US Department of Transportation. For example, a tire graded 150 would wear one

and one-half times as well on the government test track as a tire graded 100.

The relative performance of tires depends upon the actual conditions of their use, however, and may depart significantly from the norm due to variations in driving habits, service practices and differences in road characteristics and climate conditions.

Traction grade

⚠ DANGER Risk of accident due to inadequate traction

The traction grade assigned to this tire is based on straight-ahead braking traction tests, and does not include either acceleration, cornering, hydroplaning or peak traction characteristics.

- ▶ Always adapt your driving style and drive at a speed to suit the prevailing traffic and weather conditions.

! NOTE Damage to the drivetrain from wheelspin

- ▶ Avoid wheelspin.

The traction grades – from highest to lowest – are AA, A, B and C. Those grades represent the tire's ability to stop on wet pavement as measured under controlled conditions on specified government test surfaces made of asphalt and concrete.

Temperature grade

⚠ WARNING Risk of accident from tire overheating and tire failure

The temperature grade for this tire is established for a tire that is properly inflated and not overloaded. Excessive speed, underinflation, or excessive loading, either separately or in combination, can cause excessive heat build-up and possible tire failure.

- ▶ Observe the recommended tire pressures and regularly check the tire pres-

sure of all tires including the spare wheel.

- ▶ Adjust the tire pressure as necessary.

The temperature grades are A (the highest), B and C. They represent the tire's resistance to the generation of heat and its ability to dissipate heat when tested under controlled conditions on a specified indoor laboratory test wheel. Sustained high temperature can cause the material of the tire to degenerate and reduce tire life, and excessive temperature can lead to sudden tire failure. Grade C corresponds to a level of performance which all passenger car tires must meet under the requirements of the US Department of Transportation.

DOT, Tire Identification Number (TIN)

US tire regulations stipulate that every tire manufacturer or retreader must imprint a TIN in or on the side wall of each tire produced.

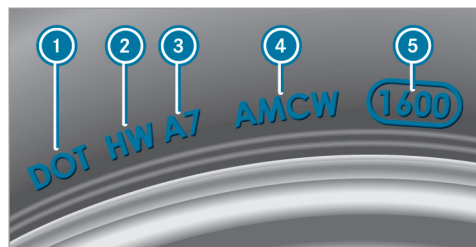

i The data shown in the image is example data.

The TIN is a unique identification number to identify tires and comprises the following:

- **DOT (Department of Transportation):** tire symbol marks **1** indicating that the tire complies with the requirements of the US Department of Transportation.
- **Manufacturer identification code:** manufacturer identification code **2** contains details of the tire manufacturer. New tires have a code with two symbols. Retreaded tires have a code with four symbols. Further information on retreaded tires (→ page 350).

- **Tire size:** identifier **3** describes the tire size.
- **Tire type code:** tire type code **4** can be used by the manufacturer as a code to describe specific characteristics of the tire.
- **Manufacturing date:** manufacturing date **5** provides information about the age of a tire. The 1st and 2nd positions represent the calendar week and the 3rd and 4th positions state the year of manufacture (e.g. "3208" represents the 32nd week of 2008).

Information on the maximum tire load



i The data shown in the image is example data.

Maximum tire load **1** is the maximum permissible weight for which the tire is approved.

Do not overload the tires by exceeding the specified load limit. The maximum permissible load can be found on the vehicle's Tire and Loading Information placard on the B-pillar on the driver's side (→ page 338).

Specifications for maximum tire pressure

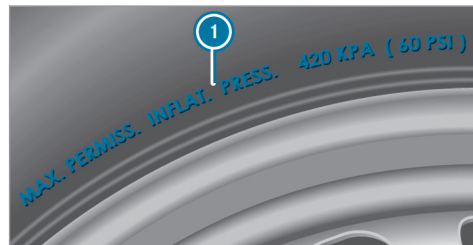

i The data shown in the image is example data.

Never exceed maximum tire pressure ❶ specified for the tire.

Information on tire characteristics

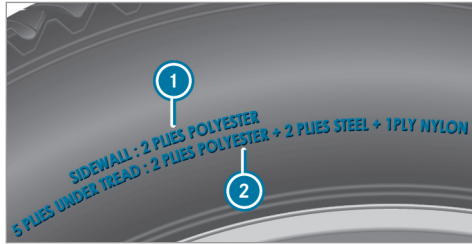

❶ The data shown in the image is example data.

This information describes the type of tire cord and the number of layers in side wall ❶ and under tire tread ❷.

Tire size designation, load-bearing capacity, speed rating and load index

⚠ WARNING Risk of injury through exceeding the specified tire load rating or the permissible speed rating

Exceeding the specified tire load rating or the permissible speed rating may lead to tire damage and to the tires bursting.

- ▶ Therefore, only use tire types and sizes approved for your vehicle model.
- ▶ Observe the tire load rating and speed rating required for your vehicle.

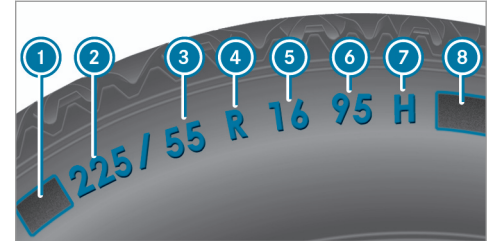

- ❶ Preceding letter
- ❷ Nominal tire width in millimeters
- ❸ Aspect ratio in %
- ❹ Tire code
- ❺ Rim diameter
- ❻ Load-bearing index
- ❼ Speed rating
- ❽ Load index

❶ The data shown in the image is example data.

Information about reading tire data can be obtained from any qualified specialist workshop.

Preceding letter 1:

- Without: passenger vehicle tires according to European manufacturing standards.
- "P": passenger vehicle tires according to US manufacturing standards.
- "LT": light truck tires according to US manufacturing standards.
- "T": compact emergency spare wheels with high tire pressure that are only designed for temporary use in an emergency.

Aspect ratio 3:

Ratio between tire height and tire width in percent (tire height divided by tire width).

Tire code 4 (tire type):

- "R" radial tire
- "D": bias ply tire
- "B": bias belted tires
- "ZR": radial tire with a maximum speed above 149 mph (240 km/h) (optional)

Rim diameter 5:

The diameter of the bead seat (not the diameter of the rim flange). The rim diameter is specified in inches (in).

Load-bearing index 6:

Numerical code that specifies the maximum load-bearing capacity of a tire (e.g. "91" corresponds to 1356 lbs (615 kg)).

The load-bearing capacity of the tire must be at least half the permissible axle load of your vehicle. Do not overload the tires by exceeding the specified load limit.

See also:

- Maximum permissible load on the Tire and Loading Information placard (→ page 338)
- Maximum tire load (→ page 344)
- Load index

Speed rating 7:

Specifies the approved maximum speed of the tire.

- **i** An electronic speed limiter prevents your vehicle from exceeding a speed of 130 mph (210 km/h).

Make sure that your tires have the required speed rating. You can obtain information on the required speed rating from an authorized Mercedes-Benz Center.

Summer tires

Index	Speed rating
Q	up to 100 mph (160 km/h)
R	up to 106 mph (170 km/h)
S	up to 112 mph (180 km/h)
T	up to 118 mph (190 km/h)
H	up to 130 mph (210 km/h)
V	up to 149 mph (240 km/h)
W	up to 168 mph (270 km/h)
Y	up to 186 mph (300 km/h)

Index	Speed rating
ZR...Y ¹	up to 186 mph (300 km/h)
ZR...(..Y) ¹	over 186 mph (300 km/h)
ZR ¹	over 149 mph (240 km/h)

- Specifying the speed rating as the "ZR" index in tire code ④ is optional for tires up to 186 mph (300 km/h).
- If your tire code ④ includes "ZR" and there is no speed rating ⑦, find out what the maximum speed is from the tire manufacturer.
- If load-bearing index ⑥ and speed rating ⑦ are in brackets, the maximum speed rating of your tire is above 186 mph (300 km/h). To find out the maximum speed, ask the tire manufacturer.

¹ "ZR" stated in the tire code.

² Or "M+S"  " for winter tires

All-weather tires and winter tires

Index	Speed rating
Q M+S ²	up to 100 mph (160 km/h)
T M+S ²	up to 118 mph (190 km/h)
H M+S ²	up to 130 mph (210 km/h)
V M+S ²	up to 149 mph (240 km/h)

Winter tires bear the  snowflake symbol and fulfill the requirements of the Rubber Manufacturers Association (RMA) and the Rubber Association of Canada (RAC) regarding the tire traction on snow.

Load index ⑧:

- No specification given: standard load (SL) tire
- "XL" or "Extra Load": extra load tire or reinforced tire
- "Light Load": light load tire

- "C", "D", "E": a load range that depends on the maximum load that the tire can carry at a certain pressure

Definition of terms for tires and loading

Tire structure and characteristics: describes the number of layers or the number of rubber-coated belts in the tire contact surface and the tire wall. These are made of steel, nylon, polyester and other materials.

Bar: metric unit for tire pressure. 14.5038 pounds per square inch (psi) and 100 kilopascal (kPa) is the equivalent of one bar.

DOT (Department of Transportation): DOT-marked tires fulfill the requirements of the US Department of Transportation.

Average weight of the vehicle occupants: the number of vehicle occupants for which the vehicle is designed, multiplied by 150 lb (68 kg).

Uniform Tire Quality Grading Standards: a uniform standard to grade the quality of tires with regard to tread quality, tire traction and temperature characteristics. The quality grading assessment is made by the manufacturer following specifications from the U.S. government. The quality grade of a tire is imprinted on the side wall of the tire.

Recommended tire pressure: the recommended tire pressure is the tire pressure specified for the tires mounted to the vehicle at the factory.

The tire and information table contains the recommended tire pressures for cold tires, the maximum permissible load and the maximum permissible vehicle speed.

The tire pressure table contains the recommended tire pressures for cold tires under various operating conditions, i.e. loading and/or speed of the vehicle.

Increased vehicle weight due to optional equipment: the combined weight of all standard and optional equipment available for the vehicle,

regardless of whether it is actually installed on the vehicle or not.

Rim: the part of the wheel on which the tire is installed.

GAWR (Gross Axle Weight Rating): the GAWR is the maximum permissible axle load. The actual load on an axle must never exceed the gross axle weight rating. The gross axle weight rating can be found on the vehicle identification plate on the B-pillar on the driver's side.

Speed rating: the speed rating is part of the tire identification. It specifies the speed range for which a tire is approved.

GVW (Gross Vehicle Weight): the gross vehicle weight comprises the weight of the vehicle including fuel, tools, the spare wheel, accessories installed, occupants, luggage and the trailer drawbar noseweight, if applicable. The gross vehicle weight must not exceed the gross vehicle weight rating GVWR as specified on the vehicle identification plate on the B-pillar on the driver's side.

GVWR (Gross Vehicle Weight Rating): the GVWR is the maximum permitted gross weight

of the fully laden vehicle (weight of the vehicle including all accessories, occupants, fuel, luggage and the trailer drawbar noseweight if applicable). The gross vehicle weight rating is specified on the vehicle identification plate on the B-pillar on the driver's side.

Maximum weight of the laden vehicle: the maximum weight is the sum of the curb weight of the vehicle, the weight of the accessories, the maximum load and the weight of optional equipment installed at the factory.

Kilopascal (kPa): metric unit for tire pressure. 6.9 kPa corresponds to 1 psi. Another unit for tire pressure is bar. 100 kilopascal (kPa) equals 1 bar.

Load index: in addition to the load-bearing index, the load index may also be imprinted on the side wall of the tire. This specifies the load-bearing capacity of the tire more precisely.

Curb weight: the weight of a vehicle with standard equipment including the maximum capacity of fuel, oil and coolant. It also includes the air conditioning system and optional equipment if

these are installed on the vehicle, but does not include passengers or luggage.

Maximum tire load: the maximum tire load is the maximum permissible weight in kilograms or lbs for which a tire is approved.

Maximum permissible tire pressure: maximum permissible tire pressure for one tire.

Maximum load on one tire: maximum load on one tire. This is calculated by dividing the maximum axle load of one axle by two.

PSI (pounds per square inch): standard unit of measurement for tire pressure.

Aspect ratio: ratio between tire height and tire width in percent.

Tire pressure: pressure inside the tire applying an outward force to every square inch of the tire. The tire pressure is specified in pounds per square inch (psi), in kilopascals (kPa) or in bar. The tire pressure should only be corrected when the tires are cold.

Cold tire pressure: the tires are cold when the vehicle has been parked for at least 3 hours

without direct sunlight on the tires or the vehicle has been driven for less than 1 mile (1.6 km).

Tire contact surface: the part of the tire that comes into contact with the road.

Tire bead: the purpose of the tire bead is to ensure that the tire sits securely on the wheel rim. There are several wire cores in the tire bead to prevent the tire from changing length on the wheel rim.

Side wall: the part of the tire between the tread and the tire bead.

Weight of optional equipment: the combined weight of the optional equipment weighing more than the replaced standard parts and more than 5 lbs (2.3 kg). This optional equipment, such as high-performance brakes, level control system, a roof luggage rack or high-performance batteries, is not included in the curb weight and the weight of the accessories.

TIN (Tire Identification Number): a unique identification number which can be used by a tire manufacturer to identify tires, for example, in a product recall, and thus identify the purchasers. The TIN is made up of the manufactur-

er's identity code, tire size, tire type code and the manufacturing date.

Load-bearing index: the load-bearing index is a code that contains the maximum load-bearing capacity of a tire.

Traction: traction is the grip resulting from friction between the tires and the road surface.

Wear indicator: narrow bars (tread wear bars) that are distributed over the tire contact surface. If the tire tread is level with the bars, the wear limit of 1/16 in (1.6 mm) has been reached.

Distribution of vehicle occupants: distribution of vehicle occupants over designated seat positions in a vehicle.

Maximum permissible payload weight: nominal load and luggage load plus 150 lb (68 kg) multiplied by the number of seats in the vehicle.

Changing a wheel

Notes on selecting, installing and replacing tires

You can ask for information regarding permitted wheel/tire combinations at an authorized Mercedes-Benz Center.

⚠ WARNING Risk of accident due to incorrect dimensions of wheels and tires

If wheels and tires of the wrong size are installed, the wheel brakes or wheel suspension components may be damaged.

- ▶ Always replace wheels and tires with those that fulfill the specifications of the original part.

When replacing wheels, make sure to fit the correct:

- Designation
- Model

When replacing tires, make sure to install the correct:

- Designation
- Manufacturer
- Model

⚠ WARNING Risk of injury through exceeding the specified tire load rating or the permissible speed rating

Exceeding the specified tire load rating or the permissible speed rating may lead to tire damage and to the tires bursting.

- ▶ Therefore, only use tire types and sizes approved for your vehicle model.
- ▶ Observe the tire load rating and speed rating required for your vehicle.

! **NOTE** Vehicle and tire damage through tire types and sizes that have not been approved

For safety reasons, only use tires, wheels and accessories which have been specially approved by Mercedes-Benz for your vehicle.

These tires are specially adapted to the control systems, such as ABS, ESP® and 4MATIC, and marked as follows:

- MO = Mercedes-Benz Original
- MOE = Mercedes-Benz Original Extended (run-flat tire only for certain wheels)
- MO1 = Mercedes-Benz Original (only certain AMG tires)

Certain characteristics, such as handling, vehicle noise emissions, fuel consumption, etc. may otherwise be adversely affected. Furthermore, other tire sizes could result in the tires rubbing against the body and axle components when loaded. This could result in damage to the tire or the vehicle.

Only use tires, wheels and accessories that have been checked and recommended by Mercedes-Benz.

! **NOTE** Risk to driving safety from retreaded tires

Retreaded tires are neither tested nor recommended by Mercedes-Benz, since previous damage cannot always be detected on retreaded tires.

For this reason driving safety cannot be guaranteed.

- ▶ Do not use used tires if you have no information about their previous usage.

! **NOTE** Possible damage to wheels or tires when driving over obstacles

Large wheels have a lower tire section width. The lower the tire section width, the greater is the risk of damage to wheels or tires when driving over obstacles.

- ▶ Avoid obstacles or drive particularly carefully.

! **NOTE** Damage to electronic component parts from the use of tire-mounting tools

Vehicles with a tire pressure monitoring system: Electronic component parts are located in the wheel. Tire-mounting tools should not be used in the area of the valve.

This could otherwise damage the electronic component parts.

- ▶ Have the tires changed at a qualified specialist workshop only.

! **NOTE** Damage to summer tires at low ambient temperatures

At low ambient temperatures, tears could form when driving with summer tires, causing permanent damage to the tires.

- ▶ At temperatures below 45 °F (7 °C), use M+S tires .

Accessory parts that are not approved for your vehicle by Mercedes-Benz or are not being used correctly can impair the operating safety.

Before purchasing and using non-approved accessories, visit a qualified specialist workshop and inquire about:

- Suitability
- Legal stipulations
- Factory recommendations

! **WARNING** Risk of accident with high performance tires

The special tire tread in combination with the optimized tire compound means that the risk of skidding or hydroplaning on wet roads is increased.

In addition, the tire grip is greatly reduced at a low outside temperature and tire running temperature.

- ▶ Switch on the ESP® and adapt your driving style accordingly.
- ▶ Use M+S tire at outside temperatures of less than 10 °C (50 °F).

Observe the following when selecting, installing and replacing tires:

- Only use tires and wheels of the same type (summer tires, winter tires, MOExtended tires) and the same make.
- Only install wheels of the same size on one axle (left and right).
It is only permissible to install a different wheel size in the event of a flat tire in order to drive to the specialist workshop.
- Only install tires of the correct size onto the wheels.
- **Vehicles with a tire pressure monitoring system:** All installed wheels must be equipped with functioning sensors for the tire pressure monitoring system.
- At temperatures below 45 °F (7 °C), use winter tires or all-season tire marked M+S for all wheels.

Winter tires bearing the  snowflake symbol in addition to the M+S marking provide the best possible grip in wintry road conditions.

- For M+S tires, only use tires with the same tread.
- Observe the maximum permissible speed for the M+S tires installed.
If this is below the vehicle's maximum speed, this must be indicated by an appropriate label in the driver's field of vision.
- Break in new tires at moderate speeds for the first 60 miles (100 km).
- Replace the tires after six years at the latest, regardless of wear.
- **When replacing with tires that do not feature run-flat characteristics:** vehicles with MOExtended tires are not equipped with a TIREFIT kit at the factory. Equip the vehicle with a TIREFIT kit after replacing with tires that do not feature run-flat characteristics, e.g. winter tires.

For more information on wheels and tires, contact a qualified specialist workshop.

Be sure to also observe the following further related subjects:

- Notes on tire pressure (→ page 331)

- Tire and Loading Information placard (→ page 338)
- Tire size designation, load-bearing capacity, speed rating and load index (→ page 345)
- Tire pressure table (→ page 333)

Notes on rotating wheels

 **WARNING** Risk of injury through different wheel sizes

Interchanging the front and rear wheels if the wheels or tires have different dimensions may severely impair the driving characteristics.

The wheel brakes or wheel suspension components may also be damaged.

- ▶ Rotate front and rear wheels only if the wheels and tires are of the same dimensions.

The wear patterns on the front and rear wheels differ:

- Front wheels wear more on the shoulder of the tire
- Rear wheels wear more in the center of the tire

On vehicles that have the same size front and rear wheels, rotate the wheels according to the intervals in the tire manufacturer's warranty book in your vehicle documents. If this is not available, rotate the tires every 3,000 to 6,000 miles (5,000 to 10,000 km), depending on the wear. Ensure that the direction of rotation is maintained.

Observe the instructions and safety notes on "Changing a wheel" when doing so (→ page 354).

Notes on storing wheels

When storing wheels, observe the following notes:

- After removing wheels, store them in a cool, dry and preferably dark place.

- Protect the tires from contact with oil, grease or fuel.

Overview of the tire-change tool kit

Apart from some country-specific variants, vehicles are not equipped with a tire-change tool kit. For more information on which tire-changing tools are required and approved for performing a wheel change on your vehicle, consult a qualified specialist workshop.

Required tire-change tools may include, for example:

- Jack
- Chock
- Lug wrench
- Alignment bolt

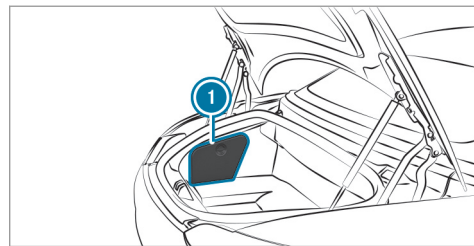

The tire-change tool kit is located on the left side of the trunk in the stowage compartment behind service flap ①.

Setting up the folding chock

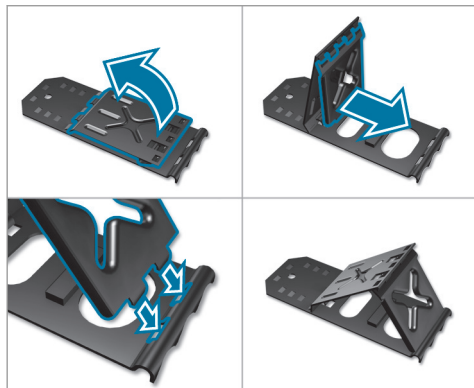

Preparing the vehicle for a wheel change

Requirements:

- The required tire-change tool kit is available. If your vehicle is not equipped with the tire-change tool kit, consult a qualified specialist workshop to find out about suitable tools.
- The vehicle is not on a slope.
- The vehicle is on solid, non-slippery and level ground.

- ▶ Apply the electric parking brake manually.
- ▶ Move the front wheels to the straight-ahead position.
- ▶ Shift the transmission to position **P**.
- ▶ Switch off the engine.
- ▶ Make sure that the engine cannot be started.
- ▶ Place chocks or other suitable items under the front and rear of the wheel that is diagonally opposite the wheel you wish to change.
- ▶ If necessary, remove the hub cap cover (→ page 354).
- ▶ Raise the vehicle (→ page 355).

Installing/removing plastic hub caps

Removing

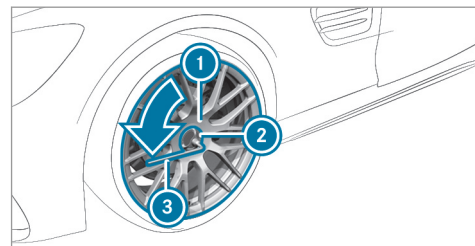

- ▶ Remove socket ② and lug wrench ③ from the vehicle tool kit (→ page 353).
- ▶ Position socket ② on hub cap ①.
- ▶ Position wheel wrench ③ on socket ②.
- ▶ Using wheel wrench ③, turn hub cap ① counter-clockwise and remove it.

Installing

- ▶ Before installing, check hub cap ① and the wheel area for dirt, and clean if necessary.

- ▶ Position hub cap ① and turn until it is in the right position.
 - ▶ Position socket ② on hub cap ①.
 - ▶ Position lug wrench ③ on socket ② and tighten hub cap ①.
- Specified tightening torque:** 18 lb-ft (25 Nm).

Raising the vehicle when changing a wheel

Requirements:

- There are no persons in the vehicle.
- The vehicle has been prepared for a wheel change (→ page 354).

Important notes on using the jack:

- Use only a vehicle-specific jack that has been approved by Mercedes-Benz to raise the vehicle.
- The jack is only designed for raising and holding the vehicle for a short time while a wheel is being changed and not for maintenance work under the vehicle.

- The jack must be placed on a firm, flat and non-slip surface. If necessary, use a large, flat, load-bearing, non-slip underlay.
- The foot of the jack must be positioned vertically under the jack support point.

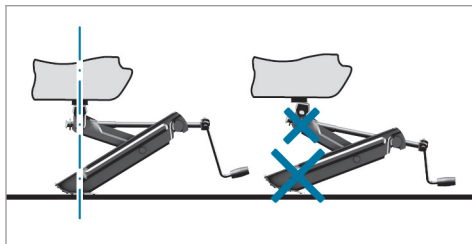

Rules of conduct when the vehicle is raised:

- Never place your hands or feet under the vehicle.
- Never lie under the vehicle.
- Do not start the engine and do not release the electric parking brake.
- Do not open or close any doors or the trunk lid.

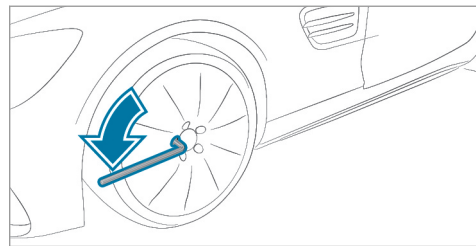

- ▶ Using the lug wrench, loosen the wheel bolts on the wheel you wish to change by about one full turn. Do not unscrew the bolts completely.

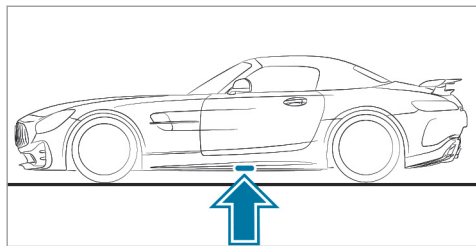

Position of jack support points

The jack support point is in the center between the front and rear wheel arches (arrow).

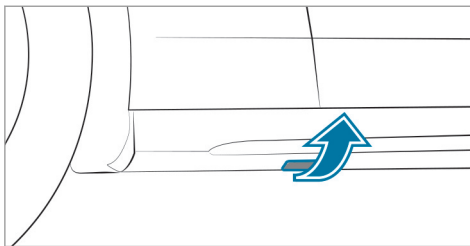

Cover of jack support points

Before positioning the jack, you must remove the cover for the jack support point.

- ▶ **To remove:** pull the cover down until the lugs are released from the holder.
- ▶ Fold the cover away in a forward direction.
- ▶ **To install:** fold the cover towards the body.
- ▶ Pull the cover down and push it in until the lugs engage.

⚠ WARNING Risk of injury from incorrect positioning of the jack

If you do not position the jack correctly at the appropriate jacking point of the vehicle, the jack could tip with the vehicle raised.

- ▶ Only position the jack at the appropriate jacking point of the vehicle. The base of the jack must be positioned vertically under the jacking point of the vehicle.

! NOTE Vehicle damage from the jack

If you do not position the jack correctly at the appropriate jack support point of the vehicle, the jack could tip over with the vehicle raised.

- ▶ The jack is designed exclusively for jacking up the vehicle at the jack support points.

- ▶ Take the ratchet out of the tire-change tool kit and place it on the hexagon nut of the jack so that the letters "AUF" are visible.

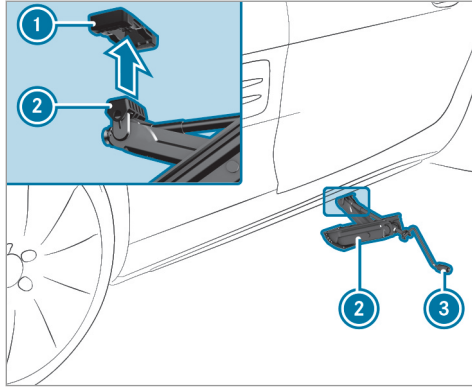

- ▶ Position jack ② at jack support point ①.
- ▶ Turn crank ③ clockwise until jack ② sits completely on jack support point ① and the base of the jack lies evenly on the ground.
- ▶ Turn crank ③ until the tire is raised a maximum of 1.2 in (3 cm) from the ground.
- ▶ Loosen and remove the wheel (→ page 357).

Removing a wheel

Requirements:

- The vehicle is raised (→ page 355).

Vehicles with AMG ceramic high-performance composite braking system:

! **NOTE** Damage to the ceramic brake disk when changing a wheel

Mercedes-AMG vehicles with ceramic brake disks: during removal and repositioning of the wheel, the wheel rim may strike the ceramic brake disk and damage it.

- ▶ Take particular care.
- ▶ Ask another person for assistance or use a second centering pin.

When changing a wheel, avoid applying any force to the brake discs, since this could impair the level of comfort when braking.

! **NOTE** Damage to threading from dirt on wheel bolts

- ▶ Do not place wheel bolts in sand or on a dirty surface.

- ▶ Unscrew the uppermost wheel bolt completely.

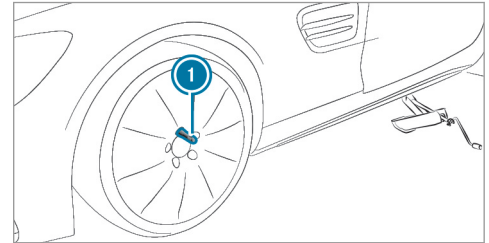

- ▶ Screw alignment bolt ① into the thread instead of the wheel bolt.
- ▶ Unscrew the remaining wheel bolts completely.
- ▶ Remove the wheel.

- ▶ Install the new wheel (→ page 358).

Mounting a new wheel

Requirements:

- The wheel is removed (→ page 357).

⚠ WARNING Risk of accident from losing a wheel

Oiled, greased or damaged wheel bolt/wheel nut threads or wheel hub/wheel mounting bolt threads can cause the wheel bolts/wheel nuts to come loose.

As a result, you could lose a wheel while driving.

- ▶ Never oil or grease the threads.
- ▶ In the event of damage to the threads, contact a qualified specialist workshop immediately.
- ▶ Have the damaged wheel bolts or damaged hub threads replaced.
- ▶ Do not continue driving.

- ▶ Observe the information on the choice of tires (→ page 350).

For tires with a specified direction of rotation, an arrow on the side wall of the tire indicates the correct direction of rotation. Observe the direction of rotation when installing.

! NOTE Damage to the ceramic brake disk when changing a wheel

Mercedes-AMG vehicles with ceramic brake disks: during removal and repositioning of the wheel, the wheel rim may strike the ceramic brake disk and damage it.

- ▶ Take particular care.
- ▶ Ask another person for assistance or use a second centering pin.

- ▶ Slide the wheel to be mounted onto the alignment bolt and push it on.

⚠ WARNING Risk of injury from tightening wheel bolts and nuts

If you tighten the wheel bolts or wheel nuts when the vehicle is raised, the jack could tip.

- ▶ Only tighten wheel bolts or wheel nuts when the vehicle is on the ground.

- ▶ Be sure to observe the instructions and safety notes on "Changing a wheel" (→ page 350).

- ▶ For safety reasons, only use wheel bolts which have been approved by Mercedes-Benz and for the wheel in question.

! NOTE Damage to paintwork of the wheel rim when screwing on the first wheel bolt

If the wheel has too much play when screwing in the first wheel bolt, the wheel rim paint can be damaged.

- ▶ Press the wheel firmly against the wheel hub when screwing on the first wheel bolt.

- ▶ Tighten the wheel bolts evenly in a diagonal pattern in the order indicated until they are finger-tight.
- ▶ Unscrew the alignment bolt.
- ▶ Tighten the last wheel bolt until it is finger-tight.
- ▶ Lower the vehicle (→ page 359).

Lowering the vehicle after a wheel change

Requirements:

- The new wheel has been installed (→ page 358).
- ▶ **To lower the vehicle:** turn the crank of the jack counter-clockwise until the vehicle is once again standing firmly on the ground.

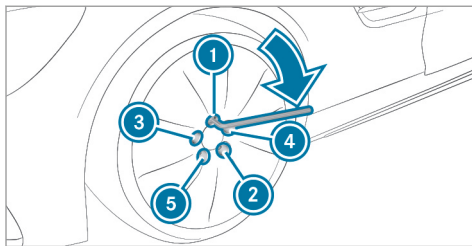

- ▶ Tighten the wheel bolts evenly in a diagonal pattern in the order indicated ① to ⑤ with a maximum of 59 lb-ft (80 Nm).
- ▶ Tighten the wheel bolts evenly in a diagonal pattern in the order indicated ① to ⑤ to the specified tightening torque of 133 lb-ft (180 Nm).

⚠ WARNING Risk of injury through incorrect tightening torque

The wheels could come loose if the wheel bolts or wheel nuts are not tightened to the prescribed tightening torque.

- ▶ Make sure the wheel bolts or wheel nuts are tightened to the prescribed tightening torque.
- ▶ If you are not sure, do not move the vehicle. Consult a qualified specialist workshop and have the tightening torque checked immediately.

- ▶ Check the tire pressure of the newly mounted wheel and adjust accordingly.
- ▶ **Vehicles with a tire pressure monitoring system:** Restart the tire pressure monitoring system (→ page 337).

Make sure to observe the following further related subject:

- Notes on tire pressure (→ page 331)

Notes on technical data

The data stated only applies to vehicles with standard equipment. You can obtain further information from an authorized Mercedes-Benz Center.

Vehicle identification plate, VIN and engine number

Vehicle identification plate

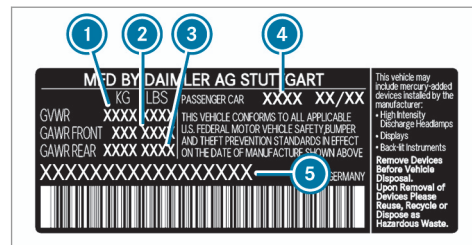
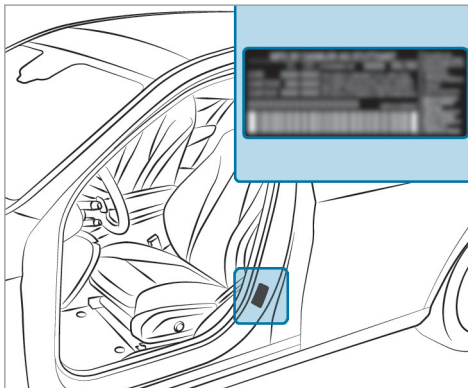

Vehicle identification plate (USA only)

- ① Permissible gross weight
- ② Permissible front axle load
- ③ Permissible rear axle load
- ④ Vehicle model
- ⑤ VIN (vehicle identification number)

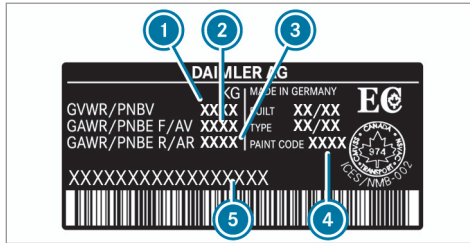

Vehicle identification plate (Canada only)

- ① Permissible gross weight
- ② Permissible front axle load
- ③ Permissible rear axle load
- ④ Paint code
- ⑤ VIN (vehicle identification number)

The permissible gross vehicle weight is made up of the vehicle weight, all vehicle occupants, the fuel and the load. The maximum gross axle weight rating is the maximum weight that can be carried on one axle (front or rear axle).

Never exceed the permissible gross vehicle weight or the maximum gross axle weight rating for the front or rear axle.

VIN in front of the right-hand front seat

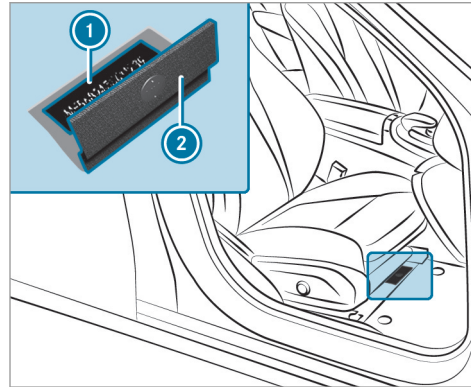

- ① Imprinted VIN (vehicle identification number)
- ② Floor covering

VIN at the lower edge of the windshield

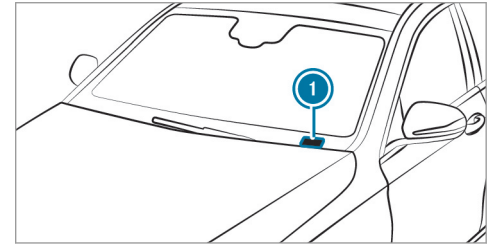

- ① VIN (vehicle identification number) as label

Additional plates

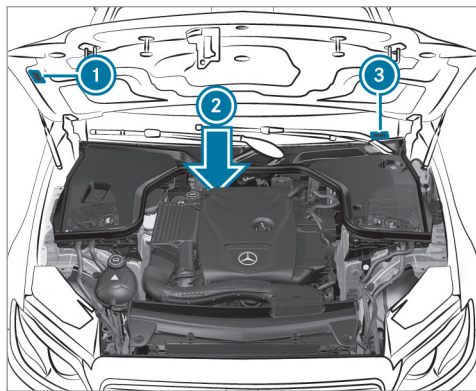

- ① Plate with information about emissions testing, including confirmation of emissions guidelines at the U.S. federal level as well as for California
- ② Engine number stamped into the crankcase
- ③ VIN (vehicle identification number) as a label at the lower edge of the windshield

Operating fluids

Notes on operating fluids

⚠ WARNING Risk of injury from operating fluids harmful to your health

Operating fluids may be poisonous and harmful to your health.

- ▶ Observe the text on the original containers when using, storing or disposing of operating fluids.
- ▶ Always store operating fluids sealed in their original containers.
- ▶ Always keep children away from operating fluids.

🌿 ENVIRONMENTAL NOTE Environmental pollution caused by environmentally irresponsible disposal

- ▶ Dispose of operating fluids in an environmentally responsible manner.

Operating fluids include the following:

- Fuels
- Lubricants
- Coolant
- Brake fluid
- Windshield washer fluid
- Climate control system refrigerant

Only use products approved by Mercedes-Benz. Damage caused by the use of products that have not been approved is not covered by the Mercedes-Benz warranty or goodwill gestures.

You can identify operating fluids approved by Mercedes-Benz by the following inscriptions on the container:

- MB-Freigabe (e.g. MB-Freigabe 229.51)
- MB-Approval (e.g. MB-Approval 229.51)

Further information on approved operating fluids is available at the following locations:

- In the Mercedes-Benz Specifications for Operating Fluids by entering the designation
 - At <http://bevo.mercedes-benz.com>

- In the Mercedes-Benz BeVo app
- At a qualified specialist workshop

▲ WARNING Risk of fire or explosion from fuel

Fuels are highly flammable.

- ▶ Fire, open flames, smoking and creation of sparks must be avoided.
- ▶ Switch off the ignition and, if available, the stationary heater, before and while refueling the vehicle.

▲ WARNING Risk of injury from fuels

Fuels are poisonous and hazardous to your health.

- ▶ Do not swallow fuel or let it come into contact with skin, eyes or clothing.
- ▶ Do not inhale fuel vapor.
- ▶ Keep children away from fuel.
- ▶ Keep doors and windows closed during the refueling process.

If you or other people come into contact with fuel, observe the following:

- ▶ Immediately rinse fuel off your skin with soap and water.
- ▶ If fuel comes into contact with your eyes, immediately rinse them thoroughly with clean water. Seek medical attention immediately.
- ▶ If you swallow fuel, seek medical attention immediately. Do not induce vomiting.
- ▶ Change immediately out of clothing that has come into contact with fuel.

Fuel

Notes on fuel grade

Observe the notes on operating fluids (→ page 362).

! NOTE Damage caused by the wrong fuel

Even small amounts of the wrong fuel could result in damage to the fuel system, the engine and the emission control system.

- ▶ Only refuel with low-sulfur unleaded fuel.

This fuel may contain up to 10% ethanol by volume. Your vehicle is suitable for use with E10 fuel.

Never refuel with one of the following fuels:

- Diesel
- Gasoline with more than 10% ethanol by volume, e.g. E15, E85, E100
- Gasoline with more than 3% methanol by volume, e.g. M15, M30, M85, M100
- Gasoline with additives containing metal

If you have accidentally refueled with the wrong fuel:

- ▶ Do not switch the ignition on.
- ▶ Consult a qualified specialist workshop.

If the available fuel is not sufficiently low in sulfur, this can produce unpleasant odors.

Only refuel using unleaded premium grade gasoline with at least 91 AKI/95 RON.

As a temporary measure, if the recommended fuel is not available, you may also use unleaded regular gasoline which has at least the octane number specified in the instruction label in the fuel filler flap (→ page 127). This may reduce engine performance and increase fuel consumption.

Never refuel using gasoline with a lower RON.

! **NOTE** Premature wear through unleaded regular gasoline

Unleaded regular gasoline can cause the engine to wear more quickly and impair longevity and performance.

If unleaded premium grade gasoline is unavailable and you have to refuel using unleaded regular gasoline:

- ▶ Only fill the fuel tank to half full with unleaded regular gasoline and fill up as

soon as possible with unleaded premium grade gasoline.

- ▶ Do not drive at the maximum design speed.
- ▶ Avoid sudden acceleration and engine speeds over 3000 rpm.

Further information on fuel is available at the following locations:

- at a gas station
- at a qualified specialist workshop
- USA only: at <http://www.mbusa.com>

Information on additives in gasoline

Observe the notes on operating fluids (→ page 362).

! **NOTE** Damage from use of unsuitable additives

Even small amounts of the wrong additive may lead to malfunctions occurring.

- ▶ Only add cleaning additives recommended by Mercedes-Benz to the fuel.

Mercedes-Benz recommends that you use fuel brands that have additives.

In some countries, the fuel available may not have sufficient additives. Residue could build up in the fuel injection system as a result. In this case, in consultation with an authorized Mercedes-Benz Center, the fuel may be mixed with the cleaning additive recommended by Mercedes-Benz. Be sure to observe the notes and mixing ratios specified on the container.

Tank content and fuel reserve

The total capacity of the fuel tank may vary, depending on the vehicle equipment.

Capacity

Model	Total capacity
Mercedes-AMG GT R Roadster	19.8 gal (75.0 liters)
Model	Of which reserve
Mercedes-AMG GT R Roadster	3.2 gal (12.0 liters)

Engine oil

Notes on engine oil

Observe the notes on operating fluids (→ page 362).



! **NOTE** Engine damage caused by an incorrect oil filter, incorrect oil or additives

▶ Do not use engine oils or oil filters other than those which meet the specifications necessary for the prescribed service intervals.

- ▶ Do not alter the engine oil or oil filter in order to achieve longer change intervals than prescribed.
- ▶ Do not use additives.
- ▶ Have the engine oil changed after the prescribed intervals.

Mercedes-Benz recommends that you have the oil change carried out at a qualified specialist workshop.

Further information on engine oil and oil filters is available at the following locations:

- In the Mercedes-Benz Specifications for Operating Fluids by entering the designation:
 - At <http://bevo.mercedes-benz.com>
 - In the Mercedes-Benz BeVo app
- at a qualified specialist workshop

Quality and capacity of engine oil

MB-Freigabe or MB-Approval

Gasoline engines	MB-Freigabe or MB-Approval
All models	229.5, 229.51

The following values refer to an oil change, including the oil filter.

Replacement amount

Model	Replacement amount
All models	1.8 gal (7.0 l)

Notes on brake fluid

Observe the notes on operating fluids (→ page 362).

⚠ WARNING Risk of an accident due to vapor pockets forming in the brake system

The brake fluid constantly absorbs moisture from the air. This lowers the boiling point of the brake fluid. If the boiling point is too low, vapor pockets may form in the brake system when the brakes are applied hard.

This causes the braking effect to be impaired.

- ▶ Have the brake fluid renewed at the specified intervals.

Have the brake fluid regularly replaced at a qualified specialist workshop.

Only use brake fluid approved by Mercedes-Benz according to MB-Freigabe or MB-Approval 331.0.

You can obtain further information on brake fluid in the following places:

- in the Mercedes-Benz Specifications for Operating Fluids
 - at <http://bevo.mercedes-benz.com>
 - in the Mercedes-Benz BeVo App

- at a qualified specialist workshop

Coolant

Notes on coolant

Observe the notes on operating fluids (→ page 362).

⚠ WARNING - Risk of fire and injury from antifreeze

If antifreeze comes into contact with hot component parts in the engine compartment, it may ignite.

- ▶ Allow the engine to cool down before adding antifreeze.
- ▶ Make sure that no antifreeze spills out next to the filler opening.
- ▶ Thoroughly clean off any antifreeze from component parts before starting the vehicle.

! NOTE Damage caused by incorrect coolant

- ▶ Only add coolant that has been pre-mixed with the required antifreeze protection.

Information on coolant is available at the following locations:

- In the Mercedes-Benz Specification for Operating Fluids 310.1
 - At <http://bevo.mercedes-benz.com>
 - In the Mercedes-Benz BeVo app
- At a qualified specialist workshop

! NOTE Overheating at high outside temperatures

If an inappropriate coolant is used, the engine cooling system is not sufficiently protected against overheating and corrosion at high outside temperatures.

- ▶ Always use coolant approved by Mercedes-Benz.

- ▶ Observe the instructions in the Mercedes-Benz Specifications for Operating Fluids 310.1.

Have the coolant regularly replaced at a qualified specialist workshop.

The proportion of corrosion inhibitor/antifreeze concentrate in the engine cooling system should be:

- a minimum of 50% (antifreeze protection down to approximately -35 °F (-37 °C))
- a maximum of 55% (antifreeze protection down to -49 °F (-45 °C))

Coolant capacity

Model	Capacity
Mercedes-AMG GT R Roadster	14.6 US qt (13.8 liters)

Notes on windshield washer fluid

Observe the notes on operating fluids (→ page 362).

⚠ WARNING - Risk of fire and injury from windshield washer concentrate

Windshield washer concentrate is highly flammable. It could ignite if it comes into contact with hot engine component parts or the exhaust system.

- ▶ Make sure that no windshield washer concentrate spills out next to the filler opening.

⚠ NOTE Damage to the exterior lighting due to unsuitable windshield washer fluid

Unsuitable windshield washer fluid may damage the plastic surface of the exterior lighting.

- ▶ Only use windshield washer fluid which is also suitable for use on plastic surfaces, e.g. MB SummerFit or MB WinterFit.

⚠ NOTE Blocked spray nozzles caused by mixing windshield washer fluids

- ▶ Do not mix MB SummerFit and MB WinterFit with other windshield washer fluids.

Do not use distilled or de-ionized water as the fill level sensor may be triggered erroneously.

Recommended windshield washer fluid:

- Above freezing point: e.g. MB SummerFit
- Below freezing point: e.g. MB WinterFit

For the correct mixing ratio, refer to the information on the antifreeze container.

Mix the washer fluid with the windshield washer fluid all year round.

Refrigerant

Notes on refrigerant

Observe the notes on operating fluids (→ page 362).

NOTE Damage due to incorrect refrigerant

If a non-approved refrigerant is used, the climate control system may be damaged.

- ▶ Only use the refrigerant R-134a

NOTE Damage to the climate control system due to incorrect refrigerant compressor oil

- ▶ Only use refrigerant compressor oil that has been approved by Mercedes-Benz.
- ▶ Do not mix the approved refrigerant compressor oil with a different refrigerant compressor oil.

Work on the climate control system may be carried out only by a qualified specialist workshop. All applicable regulations, as well as SAE standard J639, must be adhered to.

The instruction label on the climate control system for the refrigerant type and the refrigerant compressor oil is located on the inside of the hood.

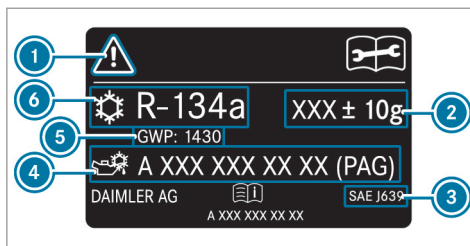

- ① Hazard and service warning symbols
- ② Refrigerant filling capacity
- ③ Applicable standards
- ④ PAG oil part number
- ⑤ GWP (Global Warming Potential) of the refrigerant used
- ⑥ Refrigerant type

Symbols ① warn of the following:

- Possible dangers
- The need to have service work carried out at a qualified specialist workshop only

Refrigerant filling capacity

Filling capacity for refrigerant and PAG oil

Model	Refrigerant
Mercedes-AMG GT R Roadster	22.6 ± 0.4 oz (640 ± 10 g)
Model	PAG oil
Mercedes-AMG GT R Roadster	4.2 ± 0.4 oz (120 ± 10 g)

Vehicle data

Vehicle dimensions

The heights specified may vary as a result of the following factors:

- Tires
- Load
- Condition of the suspension
- Optional equipment

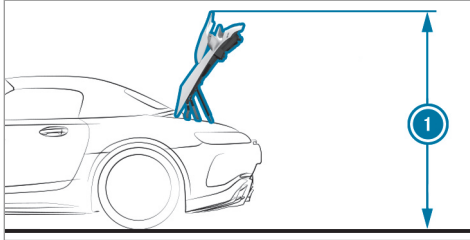

Opening height

Model	Opening height
Mercedes-AMG GT R Roadster	70.3 in (1786 mm)

Vehicle dimensions

Mercedes-AMG GT R Roadster	
Vehicle length	179.7 in (4565 mm)
Vehicle width including outside mirrors	81.7 in (2075 mm)
Vehicle width excluding outside mirrors	78.6 in (1996 mm)
Vehicle height	49.5 in (1256 mm)
Wheelbase	103.5 in (2630 mm)
Turning radius	37.63 ft (11.47 m)

Weights and loads

Please observe the following notes for the specified vehicle data:

- Items of optional equipment increase the curb weight and reduce the payload.

Roof load

Model	Maximum roof load
Mercedes-AMG GT R Roadster	0 lb (0 kg)

Maximum design speeds

The following values only apply to vehicles with the AMG Driver's Package.

Maximum design speeds

Mercedes-AMG GT R Roadster	
1st gear	45 mph (73 km/h)
2nd gear	65 mph (104 km/h)

370 Technical data

Mercedes-AMG GT R Roadster	
3rd gear	87 mph (140 km/h)
4th gear	111 mph (178 km/h)
5th gear	139 mph (223 km/h)
6th gear	171 mph (275 km/h)
7th gear	197 mph (317 km/h)

Display messages

Introduction



Notes on display messages

Display messages appear on the multifunction display.

Display messages with graphic symbols are simplified in the Operator's Manual and may differ from the symbols on the multifunction display. The multifunction display shows high-priority display messages in red. Certain display messages are accompanied by a warning tone.

Please act in accordance with the display messages and follow the additional notes in the Operator's Manual.

For some display messages, a symbol is also shown:

-  Further information
-  Hide display message

You can select the desired symbol by swiping left or right on the left-hand Touch Control. Press the  symbol to show further information

on the multifunction display. Press the  symbol to hide the display message.

You can hide low-priority display messages by pressing button  or the left-hand Touch Control. The display messages will then be stored in the message memory.

Rectify the cause of a display message as quickly as possible.

High-priority display messages cannot be hidden. The multifunction display shows these display messages continuously until the cause of the display message has been rectified.

Calling up stored display messages

On-board computer:

 [Service](#)  [1 Message](#)



If there are no display messages, [No Messages](#) will appear on the multifunction display.

▶ Scroll through the display messages by swiping upwards or downwards on the left-hand Touch Control.

▶ **To exit the message memory:** press the  button.

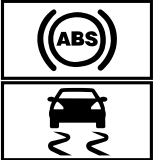

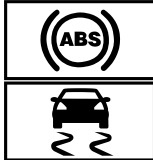

Safety systems



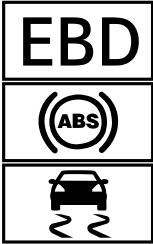

Display messages	Possible causes/consequences and ► Solutions
 <p data-bbox="144 467 408 515">Currently Unavailable See Operator's Manual</p>	<p data-bbox="476 291 1633 410">* ABS and ESP® are temporarily unavailable. Other driving systems and driving safety systems may also be temporarily unavailable. The brake system will continue to operate normally. Braking distance may increase in an emergency braking situation.</p> <div data-bbox="495 430 1646 679" style="background-color: #f0f0f0; padding: 10px;"> <p data-bbox="513 441 1190 467">▲ WARNING Risk of skidding if ABS and ESP® are malfunctioning</p> <p data-bbox="513 482 1589 534">If ABS and ESP® are malfunctioning, the wheels could lock when braking and ESP® cannot carry out vehicle stabilization.</p> <p data-bbox="513 544 1626 596">The steering capability and braking characteristics are thus severely impaired. The braking distance in an emergency braking situation can increase. In addition, other driving safety systems are switched off.</p> <ul data-bbox="513 607 1312 669" style="list-style-type: none"> ▶ Drive on carefully. ▶ Have ABS and ESP® checked immediately at a qualified specialist workshop. </div> <ul data-bbox="495 695 1633 781" style="list-style-type: none"> ▶ Drive carefully on a suitable stretch of road, making slight steering movements at a speed above 19 mph (30 km/h). ▶ If the display message does not disappear, consult a qualified specialist workshop immediately. Drive carefully.

Display messages	Possible causes/consequences and ► Solutions
 <p data-bbox="194 429 471 476">Inoperative See Operator's Manual</p>	<p data-bbox="526 253 887 274">* ABS and ESP® are malfunctioning.</p> <p data-bbox="545 284 1302 310">Other drive systems and driving safety systems may also be malfunctioning.</p> <p data-bbox="545 321 1690 367">The brake system will continue to operate normally. Braking distance may increase in an emergency braking situation.</p> <div data-bbox="554 388 1690 429" style="border: 1px solid gray; padding: 5px;"> <p data-bbox="563 398 1247 424">▲ WARNING Risk of skidding if ABS and ESP® are malfunctioning</p> </div> <p data-bbox="563 440 1644 492">If ABS and ESP® are malfunctioning, the wheels could lock when braking and ESP® cannot carry out vehicle stabilization.</p> <p data-bbox="563 502 1681 554">The steering capability and braking characteristics are thus severely impaired. The braking distance in an emergency braking situation can increase. In addition, other driving safety systems are switched off.</p> <ul data-bbox="563 564 1367 626" style="list-style-type: none"> ▶ Drive on carefully. ▶ Have ABS and ESP® checked immediately at a qualified specialist workshop. <ul data-bbox="545 652 1108 714" style="list-style-type: none"> ▶ Drive on carefully. ▶ Consult a qualified specialist workshop immediately.
 <p data-bbox="194 823 462 875">Currently Unavailable See Operator's Manual</p>	<p data-bbox="526 730 868 756">* ESP® is temporarily unavailable.</p> <p data-bbox="545 766 1321 792">Other driving systems and driving safety systems may also be malfunctioning.</p>

Display messages	Possible causes/consequences and ► Solutions
	<p>▲ WARNING Risk of skidding if ESP® is malfunctioning</p> <p>If ESP® is malfunctioning, ESP® cannot carry out vehicle stabilization. In addition, other driving safety systems are switched off.</p> <ul style="list-style-type: none"> ▶ Drive on carefully. ▶ Have ESP® checked at a qualified specialist workshop. <p>► Drive carefully on a suitable stretch of road, making slight steering movements at a speed above 19 mph (30 km/h).</p> <p>► If the display message does not disappear, consult a qualified specialist workshop immediately. Drive carefully.</p>
 <p>Inoperative See Operator's Manual</p>	<p>* ESP® is malfunctioning.</p> <p>Other driving systems and driving safety systems may also be malfunctioning.</p> <p>The brake system will continue to operate normally. The braking distance in an emergency braking situation can increase.</p> <p>▲ WARNING Risk of skidding if ESP® is malfunctioning</p> <p>If ESP® is malfunctioning, ESP® cannot carry out vehicle stabilization. In addition, other driving safety systems are switched off.</p> <ul style="list-style-type: none"> ▶ Drive on carefully. ▶ Have ESP® checked at a qualified specialist workshop.

Display messages	Possible causes/consequences and ► Solutions
<div data-bbox="205 327 362 581">  <p>The image shows three vertically stacked icons: the top one is 'EBD' in a square, the middle one is 'ABS' in a circle, and the bottom one is a car with wavy lines underneath, representing a stability control system.</p> </div> <p data-bbox="195 588 469 636">Inoperative See Operator's Manual</p>	<ul style="list-style-type: none"> ► Drive on carefully. ► Visit a qualified specialist workshop immediately. <p data-bbox="526 325 1304 387">* EBD, ABS and ESP® are malfunctioning. Other drive systems and driving safety systems may also be malfunctioning.</p> <div data-bbox="547 405 1700 650" style="border: 1px solid gray; padding: 5px;"> <p data-bbox="565 415 1295 443">▲ WARNING Risk of skidding if EBD, ABS and ESP® are malfunctioning</p> <p data-bbox="565 458 1674 508">If EBD, ABS and ESP® are malfunctioning, the wheels can lock when braking and ESP® cannot carry out vehicle stabilization.</p> <p data-bbox="565 521 1674 570">The steering capability and braking characteristics are thus severely impaired. The braking distance in an emergency braking situation can increase. In addition, other driving safety systems are switched off.</p> <ul style="list-style-type: none"> ► Drive on carefully. ► Have the brake system checked immediately at a qualified specialist workshop. </div> <ul style="list-style-type: none"> ► Drive on carefully. ► Consult a qualified specialist workshop immediately.

Display messages	Possible causes/consequences and ► Solutions
 <p>(USA only)</p>  <p>(Canada only)</p> <p>Turn On the Ignition to Release the Parking Brake</p>	<p>* The red  (USA only) or  indicator lamp (Canada only) is lit. You have attempted to release the electric parking brake with the ignition switched off.</p> <ul style="list-style-type: none">► Switch on the ignition.

Display messages	Possible causes/consequences and ► Solutions
 <p>(USA only)</p>  <p>(Canada only)</p> <p>Please Release Parking Brake</p>	<p>* The red  (USA only) indicator lamp or  (Canada only) indicator lamp is flashing.</p> <p>The electric parking brake is applied while you are driving:</p> <ul style="list-style-type: none">• A condition for automatic release of the electric parking brake is not fulfilled (→ page 137).• You are performing emergency braking using the electric parking brake (→ page 138). <p>► Check that the conditions for automatic release of the electric parking brake are fulfilled.</p> <p>► Release the electric parking brake manually.</p>

Display messages



(USA only)



(Canada only)

Parking Brake See Operator's Manual

Possible causes/consequences and ► Solutions



- * The yellow  indicator lamp is lit. The electric parking brake is malfunctioning.

To apply:

- Switch off the ignition and turn it back on.
- Apply the electric parking brake manually (→ page 137).

If it is not possible to apply the electric parking brake:

- Consult a qualified specialist workshop.
- Where necessary, also secure the parked vehicle against rolling away.

- * The yellow  indicator lamp and the red  (USA only) or  (Canada only) indicator lamp are lit. The electric parking brake is malfunctioning.

To release:

- Switch off the ignition and turn it back on.
- Release the electric parking brake manually (→ page 137).





or

- Release the electric parking brake automatically (→ page 137).

If it is still not possible to release the electric parking brake:





- Do not continue driving under any circumstances. Consult a qualified specialist workshop.



- * The yellow  indicator lamp is lit and the red  (USA only) or  (Canada only) indicator lamp is flashing. The electric parking brake is malfunctioning. The electric parking brake could not be applied or released.

Display messages	Possible causes/consequences and ► Solutions
	<ul style="list-style-type: none"> ► Switch off the ignition and turn it back on. <p>To apply:</p> <ul style="list-style-type: none"> ► Release and then apply the electric parking brake manually (→ page 137). <p>To release:</p> <ul style="list-style-type: none"> ► Apply and then release the electric parking brake manually. <p>If the electric parking brake cannot be applied or the red  (USA only) or  (Canada only) indicator lamp continues to flash:</p> <ul style="list-style-type: none"> ► Do not continue driving under any circumstances. Consult a qualified specialist workshop. ► Where necessary, also secure the parked vehicle against rolling away. <p>* The yellow  indicator lamp is on and the red  indicator lamp (USA only) or  indicator lamp (Canada only) flashes for approximately ten seconds after the electric parking brake has been applied or released. It then remains lit or goes out. The electric parking brake is malfunctioning.</p> <p>If the battery charge level is too low:</p> <ul style="list-style-type: none"> ► Charge the battery. <p>To apply:</p> <ul style="list-style-type: none"> ► Switch the ignition off. The electric parking brake is applied automatically.

Display messages	Possible causes/consequences and ► Solutions
	<p>If the electric parking brake should not be applied, e.g. when washing the vehicle in an automatic car wash or when having the vehicle towed, leave the ignition switched on. This does not include having the vehicle towed with the rear axle raised.</p> <p>If the electric parking brake is not applied automatically:</p> <ul style="list-style-type: none">► Switch off the ignition and turn it back on.► Release and then apply the electric parking brake manually (→ page 137). <p>If it is still not possible to apply the electric parking brake:</p> <ul style="list-style-type: none">► Consult a qualified specialist workshop.► Where necessary, also secure the parked vehicle against rolling away. <p>To release:</p> <ul style="list-style-type: none">► If the conditions for automatic release are fulfilled and the electric parking brake is not released automatically, release the electric parking brake manually (→ page 137). <p>If it is still not possible to release the electric parking brake:</p> <ul style="list-style-type: none">► Do not continue driving under any circumstances. Consult a qualified specialist workshop.

Display messages	Possible causes/consequences and ► Solutions
<div data-bbox="205 256 362 335" data-label="Image"> </div> <div data-bbox="194 342 303 368" data-label="Text"> <p>(USA only)</p> </div> <div data-bbox="205 381 362 459" data-label="Image"> </div> <div data-bbox="194 469 336 495" data-label="Text"> <p>(Canada only)</p> </div> <div data-bbox="194 504 439 530" data-label="Text"> <p>Check Brake Fluid Level</p> </div>	<p>* There is insufficient brake fluid in the brake fluid reservoir.</p> <div data-bbox="565 298 1698 335" data-label="Section-Header"> <p>▲ WARNING Risk of an accident due to low brake fluid level</p> </div> <p>If the brake fluid level is too low, the braking effect and the braking characteristics may be impaired.</p> <ul style="list-style-type: none"> ▶ Pull over and stop the vehicle safely as soon as possible, paying attention to road and traffic conditions. Do not continue driving under any circumstances. ▶ Consult a qualified specialist workshop. ▶ Do not add brake fluid. <ul style="list-style-type: none"> ▶ Pull over and stop the vehicle safely as soon as possible, paying attention to road and traffic conditions. Do not continue driving under any circumstances. ▶ Do not add brake fluid. ▶ Consult a qualified specialist workshop.
<div data-bbox="194 660 426 710" data-label="Text"> <p>Check Brake Pads See Operator's Manual</p> </div>	<p>* The brakepads have reached the wear limit.</p> <div data-bbox="565 705 1698 742" data-label="Section-Header"> <p>▲ WARNING Risk of accident due to restricted braking power</p> </div> <p>When the brake pads have reached their wear limit, the braking power may be restricted.</p> <ul style="list-style-type: none"> ▶ Drive on carefully. ▶ Have the brake system checked immediately at a qualified specialist workshop.

Display messages	Possible causes/consequences and ► Solutions
 <p data-bbox="144 381 395 433">SRS Malfunction Service Required</p>	<p data-bbox="495 249 925 272">► Consult a qualified specialist workshop.</p> <p data-bbox="476 288 925 310">* The restraint system is faulty (→ page 32).</p> <div data-bbox="495 332 1650 503" style="border: 1px solid gray; padding: 5px;"> <p data-bbox="513 342 1236 365">▲ WARNING Risk of injury due to malfunctions in the restraint system</p> <p data-bbox="513 381 1618 456">If the restraint system is malfunctioning, restraint system components may be triggered unintentionally or may not deploy as intended during an accident. This may affect the Emergency Tensioning Devices or airbags, for example.</p> <p data-bbox="513 467 1498 490">► Have the restraint system checked and repaired immediately at a qualified specialist workshop.</p> </div> <p data-bbox="500 519 962 541">Recognition of a restraint system malfunction:</p> <ul data-bbox="510 557 1480 614" style="list-style-type: none"> • The  restraint system warning lamp does not light up when the ignition is switched on. • The  restraint system warning lamp lights up continuously or repeatedly during a journey. <p data-bbox="495 619 1055 642">► Consult a qualified specialist workshop immediately.</p>
 <p data-bbox="144 751 421 802">Front Left Malfunction Service Required (example)</p>	<p data-bbox="476 660 1073 683">* The corresponding restraint system is faulty (→ page 32).</p> <div data-bbox="495 705 1650 873" style="border: 1px solid gray; padding: 5px;"> <p data-bbox="513 715 1236 738">▲ WARNING Risk of injury due to malfunctions in the restraint system</p> <p data-bbox="513 754 1618 829">If the restraint system is malfunctioning, restraint system components may be triggered unintentionally or may not deploy as intended during an accident. This may affect the Emergency Tensioning Devices or airbags, for example.</p> <p data-bbox="513 840 1498 862">► Have the restraint system checked and repaired immediately at a qualified specialist workshop.</p> </div>



Display messages	Possible causes/consequences and ► Solutions
	<p>Recognition of a restraint system malfunction:</p> <ul style="list-style-type: none"> • The  restraint system warning lamp does not light up when the ignition is switched on. • The  restraint system warning lamp lights up continuously or repeatedly during a journey. <p>► Consult a qualified specialist workshop immediately.</p>
<p>Front Passenger Airbag Disabled See Operator's Manual</p>	<p>* The front passenger airbag and the knee airbag has been disabled, although an adult or a person with an adult stature is on the front passenger seat. If additional forces are applied to the seat, the weight the system detects may be too low.</p> <div style="border: 1px solid gray; padding: 5px; margin: 10px 0;"> <p>⚠ WARNING Risk of injury or fatal injury due to a disabled front passenger airbag</p> <p>If the front passenger airbag is disabled, the front passenger airbag will not be deployed in the event of an accident and cannot perform its intended protective function.</p> <p>A person in the front passenger seat could then, for example, come into contact with the vehicle's interior, especially if the person is sitting too close to the cockpit.</p> <p>► Make sure, both before and during the journey, that the status of the front passenger airbag is correct.</p> </div> <ul style="list-style-type: none"> ► Pull over and stop the vehicle safely as soon as possible in accordance with the traffic conditions. ► Check the status of the automatic front passenger airbag deactivation system (→ page 43). ► If necessary, consult a qualified specialist workshop immediately.

Display messages	Possible causes/consequences and ► Solutions
<p>Front Passenger Airbag Enabled See Operator's Manual</p>	<p>* The front passenger airbag and knee airbags are enabled while the vehicle is in motion:</p> <ul style="list-style-type: none">• even when a child, a small adult or an object weighing less than the system weight threshold is located on the front passenger seat• even when the front passenger seat is not occupied <p>The system may detect objects or forces that are adding to the weight applied to the seat.</p> <p>▲ WARNING Risk of injury or fatal injury if a child restraint system is used while the front passenger front airbag is enabled</p> <p>If you secure a child in a child restraint system on the front passenger seat and the front passenger airbag is enabled, the front passenger airbag can deploy in the event of an accident.</p> <p>The child could be struck by the airbag.</p> <p>► Ensure, both before and during the journey, that the status of the front passenger airbag is correct.</p> <p>NEVER use a rearward facing child restraint on a seat protected by an ACTIVE AIRBAG in front of it, DEATH or SERIOUS INJURY to the CHILD can occur.</p> <ul style="list-style-type: none">► Stop the vehicle immediately in accordance with the traffic conditions.► Check the status of the automatic front passenger airbag actuation (→ page 43).► If necessary, consult a qualified specialist workshop immediately.

Display messages	Possible causes/consequences and ► Solutions
Active Brake Assist Functions Currently Limited See Operator's Manual	<p>* Active Brake Assist is temporarily unavailable or only partially available. The ambient conditions are outside the system limits (→ page 142).</p> <ul style="list-style-type: none"> ► Drive on. As soon as the ambient conditions are within the system limits, the system will become available again. ► If the display message does not disappear, stop the vehicle in accordance with the traffic conditions and restart the engine.
Active Brake Assist Functions Limited See Operator's Manual	<p>* Active Brake Assist is malfunctioning.</p> <ul style="list-style-type: none"> ► Consult a qualified specialist workshop.
PRE-SAFE Inoperative See Operator's Manual	<p>* The PRE-SAFE® functions are malfunctioning.</p> <ul style="list-style-type: none"> ► Consult a qualified specialist workshop.
Mercedes me connect Services Limited See Operator's Manual	<p>* Service limited. At least one of the main functions of the Mercedes me connect system is malfunctioning.</p> <ul style="list-style-type: none"> ► Observe the notes on the diagnostics connection (→ page 23). ► Consult a qualified specialist workshop.



Display messages	Possible causes/consequences and ► Solutions
 <p>Inoperative</p>	<p>* At least one of the main functions of the Mercedes me connect system or of the SOS emergency call system is malfunctioning.</p> <ul style="list-style-type: none"> ► Consult a qualified specialist workshop.
<p>Radar Sensors Dirty See Operator's Manual</p>	<p>* The radar sensor system is malfunctioning. Possible causes are:</p> <ul style="list-style-type: none"> • Dirt on the sensors • Heavy rain or snow • Extended country driving without other traffic, e.g. in the desert <p>Driving systems and driving safety systems may be malfunctioning or temporarily unavailable. Once the cause of the problem is no longer present, the driving systems and driving safety systems will be available again.</p> <p>If the display message does not disappear:</p> <ul style="list-style-type: none"> ► Pull over and stop the vehicle safely as soon as possible, paying attention to road and traffic conditions. ► Clean all sensors (→ page 307). ► Restart the engine.



Driving systems

Display messages	Possible causes/consequences and ► Solutions
 <p data-bbox="195 384 473 433">ATTENTION ASSIST Inoperative</p>	<ul style="list-style-type: none"> <li data-bbox="519 291 924 313">* ATTENTION ASSIST is malfunctioning. <li data-bbox="543 325 975 348">► Consult a qualified specialist workshop.
 <p data-bbox="195 553 473 601">ATTENTION ASSIST: Take a Break!</p>	<ul style="list-style-type: none"> <li data-bbox="519 459 1578 508">* ATTENTION ASSIST has detected fatigue or an increasing lack of concentration on the part of the driver (→ page 163). <li data-bbox="543 520 842 542">► If necessary, take a break.
 <p data-bbox="195 722 473 770">Malfunction Drive at Max. 50 mph</p>	<ul style="list-style-type: none"> <li data-bbox="519 628 1689 677">* The AMG adaptive sport suspension system is malfunctioning. The vehicle's handling characteristics may be affected. <li data-bbox="543 688 1134 711">► Do not drive at speeds greater than 50 mph (80 km/h). <li data-bbox="543 723 975 745">► Consult a qualified specialist workshop.
<p data-bbox="195 797 473 868">Blind Spot Assist Currently Unavailable See Operator's Manual</p>	<ul style="list-style-type: none"> <li data-bbox="519 797 1068 853">* Blind Spot Assist is temporarily unavailable. The system limits have been reached (→ page 166).

388 Display messages and warning/indicator lamps

Display messages	Possible causes/consequences and ► Solutions
	<ul style="list-style-type: none"> ► Drive on. Once the cause of the problem is no longer present, the system will be available again. or ► If the display message does not disappear, stop the vehicle in accordance with the traffic conditions and restart the engine. ► If necessary, clean the rear bumper. If the bumper is especially dirty, the sensors in the bumper may be malfunctioning.
Blind Spot Assist Inoperative	<ul style="list-style-type: none"> * Blind Spot Assist is malfunctioning. ► Consult a qualified specialist workshop.
Traffic Sign Assist Currently Unavailable See Operator's Manual	<ul style="list-style-type: none"> * Traffic Sign Assist is temporarily unavailable. ► Drive on. Once the cause of the problem is no longer present, the system will be available again.
Traffic Sign Assist Inoperative	<ul style="list-style-type: none"> * Traffic Sign Assist is malfunctioning. ► Stop the vehicle in accordance with the traffic conditions and restart the engine. ► If the display message continues to be displayed, consult a qualified specialist workshop.
Traffic Sign Assist Camera View Restricted See Operator's Manual	<ul style="list-style-type: none"> * The camera view is restricted. Possible causes: <ul style="list-style-type: none"> • dirt on the windshield in the camera's field of vision • heavy rain, snow or fog



Display messages	Possible causes/consequences and ► Solutions
	<p>Driving systems and driving safety systems may be malfunctioning or temporarily unavailable.</p> <p>Once the cause of the problem is no longer present, the driving systems and driving safety systems will be available again.</p> <p>If the display message does not disappear:</p> <ul style="list-style-type: none"> ► Pull over and stop the vehicle safely as soon as possible, paying attention to road and traffic conditions. ► Clean the windshield.
<div data-bbox="205 456 362 539" style="border: 1px solid black; padding: 5px; text-align: center; font-weight: bold; font-size: 1.2em;">HOLD</div> <p data-bbox="195 547 229 567">Off</p>	<p>* The HOLD function is deactivated because the vehicle is skidding or a condition for activation is not met.</p> <ul style="list-style-type: none"> ► Reactivate the HOLD function later or check the activation conditions for the HOLD function (→ page 151).
<div data-bbox="205 596 362 679" style="border: 1px solid black; padding: 5px;">  </div> <p data-bbox="195 689 279 710">--- mph</p>	<p>* Active Distance Assist DISTRONIC cannot be activated as not all activation conditions have been fulfilled.</p> <ul style="list-style-type: none"> ► Comply with the activation conditions of Active Distance Assist DISTRONIC (→ page 148).
<div data-bbox="205 737 362 820" style="border: 1px solid black; padding: 5px;">  </div> <p data-bbox="195 830 310 851">Suspended</p>	<p>* If you activate the accelerator pedal beyond the Active Distance Assist DISTRONIC setting, the system will be put into passive mode (→ page 150).</p>

Display messages	Possible causes/consequences and ► Solutions
 <p>Off</p>	<ul style="list-style-type: none"> * Active Distance Assist DISTRONIC was deactivated. If a warning tone also sounds, Active Distance Assist DISTRONIC has deactivated automatically (→ page 148).
<p>Active Distance Assist Currently Unavailable See Operator's Manual</p>	<ul style="list-style-type: none"> * Active Distance Assist DISTRONIC is temporarily unavailable. The ambient conditions are outside the system limits (→ page 147). <ul style="list-style-type: none"> ► Drive on. As soon as the ambient conditions are within the system limits, the system will become available again.
<p>Active Distance Assist Inoperative</p>	<ul style="list-style-type: none"> * Active Distance Assist DISTRONIC is malfunctioning. Other drive systems and driving safety systems may also be malfunctioning. <ul style="list-style-type: none"> ► Consult a qualified specialist workshop.
<p>Active Distance Assist Now Available</p>	<ul style="list-style-type: none"> * Active Distance Assist DISTRONIC is operational again and can be activated (→ page 148).
 <p>--- mph</p>	<ul style="list-style-type: none"> * Cruise control cannot be activated as not all activation conditions are fulfilled. <ul style="list-style-type: none"> ► Observe the activation conditions for cruise control (→ page 146).
<p>Cruise Control Inoperative</p>	<ul style="list-style-type: none"> * Cruise control is malfunctioning.

Display messages	Possible causes/consequences and ► Solutions
	<p>► Consult a qualified specialist workshop.</p>
Cruise Control Off	<p>* Cruise control has been deactivated. If there is an additional warning tone, cruise control has been deactivated automatically (→ page 145).</p>
RACE START Not Possible See Operator's Manual	<p>* Possible causes are:</p> <ul style="list-style-type: none"> • The activation conditions are not met (→ page 153).
RACE START Canceled	<p>* Possible causes are:</p> <ul style="list-style-type: none"> • You released the accelerator pedal during RACE START. • You depressed the brake pedal during RACE START. <p>You can try RACE START again at the next start.</p>



Engine

Display messages	Possible causes/consequences and ► Solutions
 <p>Check Coolant Level See Operator's Manual</p>	<p>* The coolant level is too low.</p> <div style="border: 1px solid black; padding: 5px; margin-top: 10px;"> <p>! NOTE Engine damage due to insufficient coolant</p> <p>► Avoid long journeys with insufficient coolant.</p> </div>

Display messages	Possible causes/consequences and ► Solutions
 <p>Coolant Too Hot Stop Vehicle Turn Engine Off</p>	<ul style="list-style-type: none"> ► Add coolant (→ page 300). ► Have the cooling system checked at a qualified specialist workshop. <p>* The coolant is too hot.</p> <ul style="list-style-type: none"> ► Pull over and stop the vehicle safely and switch off the engine, paying attention to road and traffic conditions. <div style="border: 1px solid gray; padding: 5px; margin: 10px 0;"> <p>▲ WARNING Danger of burns when opening the hood</p> <p>If you open the hood when the engine has overheated or during a fire in the engine compartment, you could come into contact with hot gases or other escaping operating fluids.</p> <ul style="list-style-type: none"> ► Before opening the hood, allow the engine to cool down. ► In the event of a fire in the engine compartment, keep the hood closed and call the fire service. </div> <ul style="list-style-type: none"> ► Wait until the engine has cooled down. ► Make sure that the air supply to the radiator is not impaired. ► Avoiding high loads on the engine, drive to the nearest qualified specialist workshop. In doing so, ensure that the coolant temperature display remains below the red marking.
	<p>* The fan motor is defective.</p> <ul style="list-style-type: none"> ► Avoiding high loads on the engine, drive to the nearest qualified specialist workshop. In doing so, ensure that the coolant temperature display remains below the red marking.

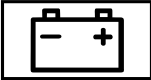
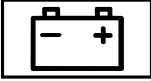

Display messages	Possible causes/consequences and ► Solutions
<p>To switch engine off, press and hold Start/Stop button for at least 3 secs. or press 3 times.</p>	<ul style="list-style-type: none"> * You have pressed the start/stop button while driving. <ul style="list-style-type: none"> ► To switch off the engine while driving, see (→ page 110).
<div data-bbox="205 381 362 464" data-label="Image"> </div> <p>12 V Battery See Operator's Manual</p>	<ul style="list-style-type: none"> * The engine is off and the battery charge level is too low. <ul style="list-style-type: none"> ► Switch off electrical consumers that are not required. <p>To charge the battery:</p> <ul style="list-style-type: none"> ► Leave the engine running for a few minutes, or drive an extended distance. * If the message appears while the engine is running, this indicates an on-board electrical system malfunction. <ul style="list-style-type: none"> ► Visit a qualified specialist workshop.
<div data-bbox="205 609 362 692" data-label="Image"> </div> <p>See Operator's Manual</p>	<ul style="list-style-type: none"> * The battery is not being charged. <div data-bbox="554 647 1696 768" data-label="Complex-Block" style="border: 1px solid black; padding: 5px; margin: 5px 0;"> <p>! NOTE Possible engine damage if you continue driving</p> <ul style="list-style-type: none"> ► Do not continue driving under any circumstances. ► Consult a qualified specialist workshop. </div> <ul style="list-style-type: none"> ► Pull over and stop the vehicle safely and switch off the engine, paying attention to road and traffic conditions. ► Consult a qualified specialist workshop.

Display messages	Possible causes/consequences and ► Solutions
 <p data-bbox="144 342 393 391">Stop Vehicle See Operator's Manual</p>	<p data-bbox="476 249 1271 273">* The battery is no longer being charged and the battery charge level is too low.</p> <div data-bbox="500 291 1648 412" style="border: 1px solid black; padding: 5px;"> <p data-bbox="513 301 1092 325">! NOTE Possible engine damage if you continue driving</p> <ul style="list-style-type: none"> <li data-bbox="513 342 1045 366">► Do not continue driving under any circumstances. <li data-bbox="513 377 944 400">► Consult a qualified specialist workshop. </div> <ul style="list-style-type: none"> <li data-bbox="495 428 1628 477">► Pull over and stop the vehicle safely as soon as possible in accordance with the traffic conditions. Do not continue driving under any circumstances. <li data-bbox="495 487 750 511">► Switch off the engine. <li data-bbox="495 522 925 545">► Consult a qualified specialist workshop.
 <p data-bbox="144 660 412 709">Stop Vehicle Leave Engine Running</p>	<p data-bbox="476 567 842 591">* The battery charge level is too low.</p> <ul style="list-style-type: none"> <li data-bbox="495 601 1628 650">► Pull over and stop the vehicle safely as soon as possible in accordance with the traffic conditions. Do not continue driving under any circumstances. <li data-bbox="495 660 787 684">► Leave the engine running. <li data-bbox="495 695 1153 718">► Wait until the display message disappears before pulling away. <li data-bbox="495 729 1387 753">► If the display message does not disappear: consult a qualified specialist workshop.

Display messages	Possible causes/consequences and ► Solutions
 <p data-bbox="195 342 347 365">Fuel Level Low</p>	<p data-bbox="519 249 1058 272">* The fuel supply has dropped into the reserve range.</p> <ul style="list-style-type: none"> <li data-bbox="543 283 652 306">► Refuel.
 <p data-bbox="195 484 347 507">Gas Cap Loose</p>	<p data-bbox="519 391 1236 414">* The fuel filler cap is not closed correctly or the fuel system is leaking.</p> <ul style="list-style-type: none"> <li data-bbox="543 425 818 448">► Close the fuel filler cap. <li data-bbox="543 459 1498 482">► If the fuel filler cap was already properly closed: consult a qualified specialist workshop.

Engine oil

Display messages	Possible causes/consequences and ► Solutions
 <p data-bbox="195 751 426 804">Check Engine Oil Level (Add 1 quart)</p>	<p data-bbox="519 657 1092 717">* Display message only for certain engines: The engine oil level has dropped to the minimum level.</p> <div data-bbox="543 733 1698 822" style="border: 1px solid black; padding: 5px;"> <p data-bbox="565 743 1273 766">! NOTE Engine damage caused by driving with insufficient engine oil</p> <ul style="list-style-type: none"> <li data-bbox="565 785 1068 808">► Avoid long journeys with insufficient engine oil. </div> <ul style="list-style-type: none"> <li data-bbox="543 837 1254 859">► When next refueling, add 1.1 US qt (1 l) of engine oil (→ page 299).

Display messages	Possible causes/consequences and ► Solutions
 <p data-bbox="144 381 421 407">Engine Oil Reduce Oil Level</p>	<p data-bbox="495 249 846 275">Notes on engine oil (→ page 365).</p> <p data-bbox="476 288 911 348">* Display message only for certain engines: The engine oil level is too high.</p> <div data-bbox="495 366 1646 453" style="border: 1px solid black; padding: 5px;"> <p data-bbox="513 376 1179 401">! NOTE Engine damage caused by driving with excess engine oil</p> <p data-bbox="513 417 975 443">► Avoid long journeys with excess engine oil.</p> </div> <p data-bbox="495 469 1428 495">► Consult a qualified specialist workshop immediately and have the engine oil level reduced.</p>
 <p data-bbox="144 601 421 653">Engine Oil Level Cannot Be Measured</p>	<p data-bbox="476 511 1489 537">* The electrical connection to the oil level sensor has been interrupted or the oil level sensor is faulty.</p> <p data-bbox="495 542 925 568">► Consult a qualified specialist workshop.</p>

Transmission

Display messages	Possible causes/consequences and ► Solutions
To Deselect P or N, Depress Brake and Start Engine	<p>* You have attempted to shift the transmission out of park position P or neutral N and into another transmission position.</p> <ul style="list-style-type: none"> ► Depress the brake pedal. ► Change the transmission position. ► Start the engine.
Driver's Door Open & Transmission Not in P Risk of Vehicle Rolling Away	<p>* The driver's door is not fully closed and transmission position D, R or neutral N is engaged.</p> <ul style="list-style-type: none"> ► Engage neutral P when switching off the vehicle.
Apply Brake to Shift to 'R'	<p>* You have attempted to select transmission position R.</p> <ul style="list-style-type: none"> ► Depress the brake pedal. ► Select transmission position R.
Only Shift to 'P' when Vehi- cle is Stationary	<p>* Park position P can be engaged only when the vehicle is stationary.</p> <ul style="list-style-type: none"> ► To stop, depress the brake pedal. ► Shift the transmission to park position P while the vehicle is stationary.
Apply Brake to Shift from 'P'	<p>* You have attempted to shift the transmission out of park position P and into another transmission position.</p> <ul style="list-style-type: none"> ► Depress the brake pedal. ► Select transmission position D, R or neutral N.

398 Display messages and warning/indicator lamps

Display messages	Possible causes/consequences and ► Solutions
N Permanently Active Risk of Rolling Away	<ul style="list-style-type: none">* While the vehicle is rolling or while you are driving, neutral N has been engaged.<ul style="list-style-type: none">► To stop, depress the brake pedal.► Shift the transmission to park position P while the vehicle is stationary.► To continue driving, select transmission position D or R.
Service Required Do Not Shift Gears Visit Dealer	<ul style="list-style-type: none">* The transmission is malfunctioning. The transmission position can no longer be changed.<ul style="list-style-type: none">► When transmission position D is selected, consult a qualified specialist workshop and do not change the transmission position.► For all other transmission positions, park the vehicle safely.► Consult a qualified specialist workshop or breakdown service.
Reversing Not Possible Service Required	<ul style="list-style-type: none">* The transmission is malfunctioning. The transmission position R cannot be selected.<ul style="list-style-type: none">► Consult a qualified specialist workshop.
Transmission Malfunction Stop	<ul style="list-style-type: none">* The transmission is malfunctioning. The transmission shifts to neutral N automatically.<ul style="list-style-type: none">► Pull over and stop the vehicle safely as soon as possible in accordance with the traffic conditions.► Depress the brake pedal.► Engage park position P.► Consult a qualified specialist workshop.



Display messages	Possible causes/consequences and ► Solutions
<p>Stop Vehicle Leave Engine Running Wait Transmission Cooling</p>	<ul style="list-style-type: none"> * The transmission is overheating. Pulling away may be temporarily impaired or not possible. <ul style="list-style-type: none"> ► Pull over and stop the vehicle safely as soon as possible in accordance with the traffic conditions. Do not continue driving under any circumstances. ► Leave the engine running. ► Wait until the display message disappears before pulling away.
<p>Auxiliary Battery Malfunction</p>	<ul style="list-style-type: none"> * The auxiliary battery for the transmission is no longer being charged. <ul style="list-style-type: none"> ► Consult a qualified specialist workshop. ► Until then, manually select transmission position P before you switch off the engine. ► Before leaving the vehicle, apply the electric parking brake.
<div style="border: 1px solid black; width: 40px; height: 40px; margin: 0 auto; display: flex; align-items: center; justify-content: center;">  </div> <p>Transmission Oil Cooling Malfunction</p>	<ul style="list-style-type: none"> * The transmission's coolant pump is faulty. The transmission may overheat. <ul style="list-style-type: none"> ► Select the Performance menu in the on-board computer and check the transmission oil temperature (→ page 174). ► Avoid a high load with a dynamic driving style. ► If transmission oil temperatures are below 248 °F (120 °C), drive on to the nearest qualified specialist workshop.



400 Display messages and warning/indicator lamps

Display messages	Possible causes/consequences and ► Solutions
 <p data-bbox="144 342 365 391">Trans. Oil Overheated Drive on with Care</p>	<p data-bbox="476 249 1622 301">* Transmission position M and the temporary manual driving program are no longer available. The engine output is reduced depending on the overheating.</p> <p data-bbox="495 311 1452 335">► Let the transmission oil cool down by driving defensively until the display message goes out.</p>

Tires



Display messages	Possible causes/consequences and ► Solutions
<p data-bbox="144 544 389 593">Tire Press. Monitor Cur- rently Unavailable</p>	<p data-bbox="476 544 1641 593">* There is interference from a powerful radio signal source. As a result, no signals from the tire pressure sensors are being received. The tire pressure monitor is temporarily unavailable.</p> <p data-bbox="495 603 1415 655">► Drive on. The tire pressure monitor restarts automatically as soon as the cause has been rectified.</p>
<p data-bbox="144 671 426 720">Tire Press. Monitor Inopera- tive</p>	<p data-bbox="476 671 838 695">* The tire pressure monitor is faulty.</p> <div data-bbox="495 712 1644 852"><p data-bbox="513 720 1517 746">▲ WARNING There is a risk of an accident if the tire pressure monitoring system is malfunctioning</p><p data-bbox="513 757 1628 809">If the tire pressure monitoring system is malfunctioning, it is not able to issue a warning if there is pressure loss in one or more of the tires.</p><p data-bbox="513 819 1437 847">Underinflated tires may, for example, impair the driving, steering and braking characteristics.</p></div>



Display messages	Possible causes/consequences and ► Solutions
	<p>► Have the tire pressure monitoring system checked at a qualified specialist workshop.</p> <p>► Consult a qualified specialist workshop.</p>
<p>Tire Pressure Monitor Inoperative No Wheel Sensors</p>	<p>* The wheels installed do not have suitable tire pressure sensors. The tire pressure monitor is deactivated.</p> <p>► Install wheels with suitable tire pressure sensors.</p>
 <p>Wheel Sensor(s) Missing</p>	<p>* There is no signal from the tire pressure sensor of one or more wheels. No pressure value is displayed for the affected tire.</p> <p>► Have the faulty tire pressure sensor replaced at a qualified specialist workshop.</p>
 <p>Check Tires</p>	<p>* The tire pressure in one or more tires has dropped significantly. The wheel position is displayed.</p> <p>▲ WARNING Risk of an accident due to insufficient tire pressure</p> <p>Tire pressures that are too low pose the following hazards:</p> <ul style="list-style-type: none"> • The tires may burst, especially as the load and vehicle speed increase. • The tires may wear excessively and/or unevenly, which may greatly impair tire traction. • The driving characteristics, as well as steering and braking, may be greatly impaired. <p>You could then lose control of the vehicle.</p> <p>► Observe the recommended tire pressure.</p>

Display messages	Possible causes/consequences and ► Solutions
	<ul style="list-style-type: none"> ► Adjust the tire pressure if necessary. ► Stop the vehicle in accordance with the traffic conditions. ► Check the tire pressure (→ page 331) and the tires.
 <p data-bbox="144 477 395 526">Please Correct Tire Pressure</p>	<p data-bbox="476 384 1596 433">* The tire pressure is too low in at least one of the tires, or the difference in tire pressure between the individual wheels is too great.</p> <ul style="list-style-type: none"> ► Check the tire pressure and add air, if necessary. ► When the tire pressure is correct, restart the tire pressure monitor (→ page 337).
 <p data-bbox="144 646 395 671">Warning Tire Malfunction</p>	<p data-bbox="476 553 1421 578">* The tire pressure in one or more tires has dropped suddenly. The wheel position is displayed.</p> <div style="background-color: #f0f0f0; padding: 5px; margin-bottom: 10px;"> <p data-bbox="513 601 1130 626">▲ WARNING Risk of an accident from driving with a flat tire</p> </div> <p data-bbox="513 643 968 668">Flat tires are dangerous in the following ways:</p> <ul style="list-style-type: none"> • The tires can overheat and cause a fire. • The driving characteristics, as well as steering and braking, may be greatly impaired. <p data-bbox="513 754 931 779">You could then lose control of the vehicle.</p> <ul style="list-style-type: none"> ► Do not drive with a flat tire. ► Observe the notes on flat tires.



Display messages	Possible causes/consequences and ► Solutions
	<p>Notes on flat tires (→ page 312).</p> <ul style="list-style-type: none"> ► Stop the vehicle in accordance with the traffic conditions. ► Check the tires.
Tires Overheated	<p>* At least one tire is overheating. The affected tires are displayed in red. At temperatures close to the limit value, the tires are displayed in yellow.</p> <ul style="list-style-type: none"> ► Drive more slowly.
Decrease Speed	<p>* At least one tire is overheating. The affected tires are displayed in red. At temperatures close to the limit value, the tires are displayed in yellow.</p> <div style="border: 1px solid gray; padding: 5px; margin: 10px 0;"> <p>⚠ WARNING Risk of an accident from driving with overheated tires</p> <p>Overheated tires may burst, particularly at high speeds.</p> <ul style="list-style-type: none"> ► Reduce speed so that the tires cool down. </div> <ul style="list-style-type: none"> ► Reduce speed so that the tires cool down.



SmartKey



Display messages	Possible causes/consequences and ► Solutions
 Obtain a New Key	<ul style="list-style-type: none">* The SmartKey needs to be replaced.<ul style="list-style-type: none">► Visit a qualified specialist workshop.
 Replace Key Battery	<ul style="list-style-type: none">* The SmartKey battery is discharged.<ul style="list-style-type: none">► Replace the battery (→ page 56).
 Key Not Detected (white display message)	<ul style="list-style-type: none">* The SmartKey is currently undetected.<ul style="list-style-type: none">► Change the location of the SmartKey in the vehicle.► If the SmartKey is still not recognized, start the vehicle with the SmartKey (→ page 111).

Display messages	Possible causes/consequences and ► Solutions
 <p data-bbox="195 344 473 394">Key Not Detected (red display message)</p>	<p data-bbox="524 249 1252 273">* The SmartKey cannot be detected and may no longer be in the vehicle.</p> <p data-bbox="543 283 1252 307">The SmartKey is no longer in the vehicle and you switch off the engine:</p> <ul data-bbox="543 318 953 377" style="list-style-type: none"> <li data-bbox="543 318 931 341">• You can no longer start the engine. <li data-bbox="543 352 953 377">• You cannot centrally lock the vehicle. <p data-bbox="543 394 1005 418">► Ensure that the SmartKey is in the vehicle.</p> <p data-bbox="543 446 1434 470">If the SmartKey detection function has a malfunction due to a strong radio signal source:</p> <ul data-bbox="543 480 1557 539" style="list-style-type: none"> <li data-bbox="543 480 1557 504">► Pull over and stop the vehicle safely as soon as possible in accordance with the traffic conditions. <li data-bbox="543 514 1082 539">► Start the vehicle with the SmartKey (→ page 111).
 <p data-bbox="195 650 301 674">Insert Key</p>	<p data-bbox="524 557 981 581">* The SmartKey is not detected continuously.</p> <p data-bbox="543 591 1517 615">Detection of the SmartKey is temporarily malfunctioning or faulty. A warning tone will also sound.</p> <ul data-bbox="543 625 1341 684" style="list-style-type: none"> <li data-bbox="543 625 1341 649">► Insert the SmartKey in the ignition lock and turn to the desired key position. <li data-bbox="543 659 977 684">► Consult a qualified specialist workshop.
 <p data-bbox="195 793 421 817">Don't Forget Your Key</p>	<p data-bbox="524 700 1646 749">* A warning tone will also sound. This message reminds you to take your SmartKey with you when you leave the vehicle.</p>



Vehicle

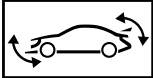

Display messages	Possible causes/consequences and ► Solutions
 <p data-bbox="144 381 373 458">Vehicle Ready to Drive Switch the Ignition Off Before Exiting</p>	<p data-bbox="476 288 1110 311">* You are leaving the vehicle when it is in a ready-to-drive state.</p> <ul style="list-style-type: none"> <li data-bbox="495 322 1628 373">► When you leave the vehicle, switch off the ignition, secure the vehicle against rolling away and take the Smart-Key with you. <li data-bbox="495 384 1641 458">► If you do not leave the vehicle, switch off the electrical consumers, e.g. the seat heating. Otherwise, the 12V battery may discharge and it will then be possible to start the vehicle only using a donor battery (starting assistance).
 <p data-bbox="144 572 395 650">Steering Malfunction Increased Physical Effort See Operator's Manual</p>	<p data-bbox="476 484 1049 508">* The power assistance for the steering is malfunctioning.</p> <div data-bbox="495 526 1646 681" style="border: 1px solid gray; padding: 5px;"> <p data-bbox="513 533 1245 557">▲ WARNING Risk of an accident due to altered steering characteristics</p> <p data-bbox="513 572 1581 596">If the power assistance of the steering fails partially or completely, you will need to use more force to steer.</p> <ul style="list-style-type: none"> <li data-bbox="513 607 994 630">► If safe steering is possible, drive on carefully. <li data-bbox="513 641 1142 665">► Visit or consult a qualified specialist workshop immediately. </div> <ul style="list-style-type: none"> <li data-bbox="495 695 975 718">► If safe steering is possible, drive on carefully. <li data-bbox="495 729 1123 753">► Visit or consult a qualified specialist workshop immediately.

Display messages	Possible causes/consequences and ► Solutions
 <p data-bbox="195 344 463 418">Steering Malfunction Stop Immediately See Operator's Manual</p>	<p data-bbox="524 249 1299 275">* The steering is malfunctioning. Steering capability is considerably impaired.</p> <div data-bbox="547 291 1696 470" style="border: 1px solid gray; padding: 5px;"> <p data-bbox="565 301 1206 327">▲ WARNING Risk of accident if steering capability is impaired</p> <p data-bbox="565 339 1461 365">If the steering does not function as intended, the vehicle's operating safety is jeopardized.</p> <ul style="list-style-type: none"> <li data-bbox="565 376 1633 427">▶ Pull over and stop the vehicle safely as soon as possible, paying attention to road and traffic conditions. Do not continue driving under any circumstances. <li data-bbox="565 438 994 464">▶ Consult a qualified specialist workshop. </div> <ul style="list-style-type: none"> <li data-bbox="547 490 1677 541">▶ Pull over and stop the vehicle safely as soon as possible in accordance with the traffic conditions. Do not continue driving under any circumstances. <li data-bbox="547 552 975 578">▶ Consult a qualified specialist workshop.
 <p data-bbox="195 686 476 738">Rear Axle Steering Malfunction Service Required</p>	<p data-bbox="524 591 944 617">* The rear-axle steering is malfunctioning.</p> <p data-bbox="547 627 944 653">The rear axle has no steering capability.</p> <p data-bbox="547 664 1276 689">The steering wheel may not be centered when you drive in a straight line.</p> <ul style="list-style-type: none"> <li data-bbox="547 700 1064 726">▶ Adapt your speed and continue driving carefully. <li data-bbox="547 736 1073 762">▶ Visit a qualified specialist workshop immediately.

Display messages	Possible causes/consequences and ► Solutions
 <p>Rear Axle Steering Currently Unavailable</p>	<ul style="list-style-type: none"> * The rear-axle steering is temporarily unavailable. The turning circle may become wider. <ul style="list-style-type: none"> ► Stop the vehicle in accordance with the traffic conditions and restart the engine. If the display message does not disappear: <ul style="list-style-type: none"> ► Drive on carefully. ► Consult a qualified specialist workshop.
<p>Electronic Rear Axle Differential Lock Inoperative</p>	<ul style="list-style-type: none"> * The electronic rear axle locking differential is inoperative. <ul style="list-style-type: none"> ► Consult a qualified specialist workshop.
<p>Electronic Rear Axle Differential Lock Currently Unavailable</p>	<ul style="list-style-type: none"> * The motor of the electronic rear axle locking differential is overheating. <ul style="list-style-type: none"> ► Let the electronic rear axle locking differential cool down by driving defensively.
 <p>Traction Control Inoperative See Operator's Manual</p>	<ul style="list-style-type: none"> * The traction control is malfunctioning. <ul style="list-style-type: none"> ► Consult a qualified specialist workshop.

Display messages	Possible causes/consequences and ► Solutions
 <p data-bbox="195 342 473 391">Spoilers Extended Caution, Reduced Ground Clearance</p>	<p data-bbox="524 249 1696 298">* The active aerodynamic profile cannot reach the end position when retracting or extending and will reverse if possible.</p> <p data-bbox="543 311 1240 335">If extending or retracting of the active aerodynamic profile is blocked:</p> <ul style="list-style-type: none"> <li data-bbox="543 342 1153 366">► Ensure that the cause of the blockage has been removed. <li data-bbox="543 377 1005 400">► Switch off the engine and lock the vehicle. <li data-bbox="543 411 1221 459">► Start the vehicle after a few minutes. The active aerodynamic profile will move to the original position. <p data-bbox="543 491 1106 514">If the problem persists or the cause cannot be detected:</p> <ul style="list-style-type: none"> <li data-bbox="543 525 977 549">► Consult a qualified specialist workshop.
<p data-bbox="195 565 450 614">Rear Spoiler Control System Inoperative</p>	<p data-bbox="524 565 1461 589">* The rear wing cannot reach the end position during retraction and extends again if possible.</p> <p data-bbox="543 599 931 623">The vehicle's speed may be restricted.</p> <p data-bbox="543 634 1055 657">If retraction of the rear wing is blocked, e.g. by ice:</p> <ul style="list-style-type: none"> <li data-bbox="543 668 1153 692">► Ensure that the cause of the blockage has been removed. <li data-bbox="543 702 1005 726">► Switch off the engine and lock the vehicle. <li data-bbox="543 736 1033 785">► Start the vehicle after a few minutes. The rear wing will move to the initial position. <p data-bbox="543 816 1106 840">If the problem persists or the cause cannot be detected:</p> <ul style="list-style-type: none"> <li data-bbox="543 850 977 874">► Consult a qualified specialist workshop.

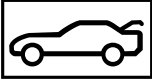
Display messages	Possible causes/consequences and ► Solutions
<p>Rear Spoiler Inoperative Limit ### mph</p>	<p>* The vehicle's speed is limited to the value displayed. Therefore, the rear wing cannot reach the end position during extension and only extends as far as is possible.</p> <p>If extension of the rear wing is blocked, e.g. by ice:</p> <ul style="list-style-type: none"> ► Ensure that the cause of the blockage has been removed. ► Switch off the engine and lock the vehicle. ► Start the vehicle after a few minutes. The rear wing will move to the initial position. <p>If the problem persists or the cause cannot be detected:</p> <ul style="list-style-type: none"> ► Consult a qualified specialist workshop.
	<p>* At least one door is open.</p> <ul style="list-style-type: none"> ► Close all doors.
	<p>* The hood is open.</p> <div style="background-color: #f0f0f0; padding: 5px; margin-bottom: 5px;"> <p>▲ WARNING Risk of accident if the engine hood is unlatched while driving</p> </div> <p>An unlocked engine hood may open up when the vehicle is in motion and block your view.</p> <ul style="list-style-type: none"> ► Never unlatch the engine hood while driving. ► Before every trip, ensure that the engine hood is latched.

Display messages	Possible causes/consequences and ► Solutions
	<ul style="list-style-type: none"> ► Stop the vehicle immediately, paying attention to road and traffic conditions. ► Close the hood.
	<p>* The trunk lid is open.</p> <div style="border: 1px solid gray; padding: 5px; margin: 5px 0;"> <p>⚠ DANGER Risk of exhaust gas poisoning</p> <p>Combustion engines emit poisonous exhaust gases such as carbon monoxide. Exhaust gases can enter the vehicle interior if the trunk lid is open when the engine is running, especially if the vehicle is in motion.</p> <ul style="list-style-type: none"> ► Always switch off the engine before opening the trunk lid. ► Never drive with the trunk lid open. </div> <ul style="list-style-type: none"> ► Close the trunk lid.
 <p>Check Washer Fluid</p>	<p>* The washer fluid level in the washer fluid reservoir has dropped below the minimum.</p> <ul style="list-style-type: none"> ► Add washer fluid (→ page 301).

Soft top

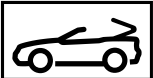
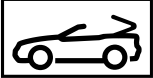
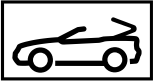

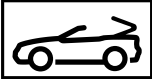
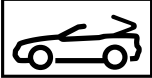

Display messages	Possible causes/consequences and ► Solutions
 <p>While stationary, apply the brakes before operating the soft top.</p>	<ul style="list-style-type: none"> * The vehicle is stationary and you try to open or close the soft top. <ul style="list-style-type: none"> ► Depress the brake pedal. ► Push or pull the soft top switch again until the soft top is fully open or closed.
 <p>Convertible Top Operation Possible to 37 mph</p>	<ul style="list-style-type: none"> * If you drive at speeds greater than 37 mph (60 km/h) you cannot open or close the soft top. <ul style="list-style-type: none"> ► Do not drive at speeds greater than 37 mph (60 km/h). ► Fully open or close the soft top.
 <p>Convertible Top Lowering</p>	<ul style="list-style-type: none"> * The soft top is not fully opened or closed. The hydraulics are depressurizing. <ul style="list-style-type: none"> ► Fully open or close the soft top.

Display messages	Possible causes/consequences and ► Solutions
 <p data-bbox="195 344 445 394">Open/Close Convertible Top Completely</p>	<p data-bbox="522 251 1690 301">* The soft top is not locked. If you drive at speeds greater than 37 mph (60 km/h) you cannot open or close the soft top.</p> <ul style="list-style-type: none"> <li data-bbox="543 311 1134 337">► Do not drive at speeds greater than 37 mph (60 km/h). <li data-bbox="543 344 898 370">► Fully open or close the soft top.
 <p data-bbox="195 513 445 563">12 V Battery See Operator's Manual</p>	<p data-bbox="522 420 1036 446">* The on-board electrical system voltage is too low.</p> <ul style="list-style-type: none"> <li data-bbox="543 453 750 479">► Start the engine.

Lights

Display messages	Possible causes/consequences and ► Solutions
 <p data-bbox="195 804 362 854">Check Left Low Beam (Example)</p>	<p data-bbox="522 711 944 737">* The corresponding light source is faulty.</p> <ul style="list-style-type: none"> <li data-bbox="543 747 761 773">► Drive on carefully. <li data-bbox="543 781 1103 807">► Consult a qualified specialist workshop immediately. <li data-bbox="543 814 1702 864">ⓘ LED light bulbs: the display message for the corresponding lamp appears only when all the light-emitting diodes in the lamp have failed.

414 Display messages and warning/indicator lamps

Display messages	Possible causes/consequences and ► Solutions
 <p data-bbox="144 342 384 391">Malfunction See Operator's Manual</p>	<p data-bbox="469 249 783 273">* The exterior lighting is faulty.</p> <ul data-bbox="495 283 925 307" style="list-style-type: none"><li data-bbox="495 283 925 307">► Consult a qualified specialist workshop.
 <p data-bbox="144 511 421 560">Automatic Headlamp Mode Inoperative</p>	<p data-bbox="469 418 746 442">* The light sensor is faulty.</p> <ul data-bbox="495 452 894 476" style="list-style-type: none"><li data-bbox="495 452 894 476">► Visit a qualified specialist workshop.
 <p data-bbox="144 680 371 702">Switch On Headlamps</p>	<p data-bbox="469 587 949 611">* You are driving without low-beam headlamps.</p> <ul data-bbox="495 621 1031 645" style="list-style-type: none"><li data-bbox="495 621 1031 645">► Turn the light switch to the  or AUTO position.
 <p data-bbox="144 819 316 841">Switch Off Lights</p>	<p data-bbox="469 729 1116 753">* You are leaving the vehicle and the lights are still switched on.</p> <ul data-bbox="495 763 949 787" style="list-style-type: none"><li data-bbox="495 763 949 787">► Turn the light switch to the AUTO position.

Display messages	Possible causes/consequences and ► Solutions
<p>Adaptive Highbeam Assist Currently Unavailable See Operator's Manual</p>	<p>* Adaptive Highbeam Assist is temporarily unavailable. The system limits have been reached (→ page 97).</p> <p>► Drive on. Once the cause of the problem is no longer present, the system will be available again. The Adaptive Highbeam Assist Now Available display message appears.</p>
<p>Adaptive Highbeam Assist Inoperative</p>	<p>* Adaptive Highbeam Assist is malfunctioning.</p> <p>► Consult a qualified specialist workshop.</p>
<p>Adaptive Highbeam Assist Camera View Restricted See Operator's Manual</p>	<p>* The camera view is restricted. Possible causes are:</p> <ul style="list-style-type: none"> • Dirt on the windshield in the camera's field of vision • Heavy rain, snow or fog <p>Driving systems and driving safety systems may be malfunctioning or temporarily unavailable. Once the cause of the problem is no longer present, the driving systems and driving safety systems will be available again.</p> <p>If the display message does not disappear:</p> <p>► Pull over and stop the vehicle safely as soon as possible, paying attention to road and traffic conditions.</p> <p>► Clean the windshield.</p>
<p>Hazard Warning Flashers Malfunctioning</p>	<p>* The hazard warning lamp switch is faulty.</p> <p>► Consult a qualified specialist workshop.</p>

Warning and indicator lamps

Overview of indicator and warning lamps

Some systems will perform a self-test when the ignition is switched on. Some indicator and warning lamps may briefly light up or flash. This behavior is non-critical. These indicator and warning lamps indicate a malfunction only if they light up or flash after the engine has been started or during a journey.

Instrument Display

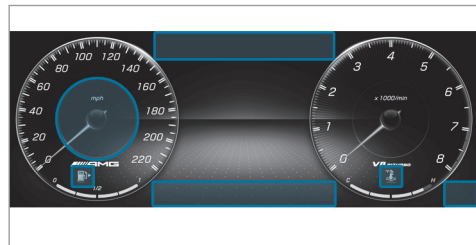





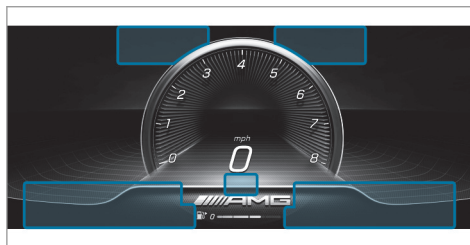

Depending on the display setting, the positions of the indicator lamps on the Instrument Display may differ from the example shown.

Supersport setting



If you select the supersport display setting, the positions of the indicator lamps on the Instrument Display will change.

Indicator and warning lamps:

-  Low beam (→ page 95)
-  Parking lamps (→ page 95)
-  High beam (→ page 96)
-  Turn signal lights (→ page 96)
-  Rear fog light (→ page 95)
-  Restraint system (→ page 417)
-  Seat belt not fastened (→ page 424)



USA: brakes (red) (→ page 417)



Canada: brakes (red) (→ page 417)



Electric parking brake (yellow)
(→ page 417)



USA: electric parking brake applied
(red) (→ page 417)



Canada: electric parking brake
applied (red) (→ page 417)



ABS malfunction (→ page 417)



ESP® (→ page 417)



ESP® OFF (→ page 417)



ESP® SPORT (→ page 417)



Distance warning (→ page 425)



Electric power steering malfunction
(→ page 430)



AMG adaptive sport suspension system
malfunction (→ page 425)



Check Engine (→ page 426)



Electrical malfunction (→ page 426)



Fuel reserve with fuel filler cap location
indicator (→ page 426)





Coolant too hot/cold (→ page 426)





Tire pressure monitor (→ page 429)

Safety systems



Warning/indicator lamp	Possible causes/consequences and ► Solutions
 <p data-bbox="194 471 378 502">ABS warning lamp</p>	<p data-bbox="508 378 1127 409">The yellow ABS warning lamp is lit while the engine is running.</p> <p data-bbox="508 414 757 445">*ABS is malfunctioning.</p> <p data-bbox="508 450 1136 481">If there is an additional warning tone, EBD is malfunctioning.</p> <p data-bbox="508 486 1302 518">Other driving systems and driving safety systems may also be malfunctioning.</p> <div data-bbox="526 528 1690 740" style="border: 1px solid gray; padding: 5px;"> <p data-bbox="535 533 1284 564">▲ WARNING There is a risk of skidding if EBD or ABS is malfunctioning</p> <p data-bbox="535 574 1228 606">If EBD or ABS is malfunctioning, the wheels may lock when braking.</p> <p data-bbox="535 611 1672 663">The steering capability and braking characteristics are thus severely impaired. The braking distance in an emergency braking situation can increase. In addition, other driving safety systems are switched off.</p> <ul style="list-style-type: none"> <li data-bbox="535 668 766 699">► Drive on carefully. <li data-bbox="535 704 1376 735">► Have the brake system checked immediately at a qualified specialist workshop. </div> <ul style="list-style-type: none"> <li data-bbox="526 756 748 787">► Drive on carefully. <li data-bbox="526 792 1044 823">► Note the messages on the multifunction display. <li data-bbox="526 828 933 859">► Visit a qualified specialist workshop.

Warning/indicator lamp	Possible causes/consequences and ► Solutions
 <p>ESP® warning lamp flashes</p>	<p>The yellow ESP® warning lamp flashes while the vehicle is in motion.</p> <p>* At least one wheel and tire assembly has reached its grip limit (→ page 140).</p> <ul style="list-style-type: none"> ► Adapt your driving style to suit the road and weather conditions.
 <p>ESP® warning lamp lights up</p>	<p>The yellow ESP® warning lamp is lit while the engine is running.</p> <p>*ESP® is malfunctioning</p> <p>Other driving systems and driving safety systems may also malfunction.</p> <div style="border: 1px solid black; padding: 5px; margin: 10px 0;"> <p>⚠ WARNING Risk of skidding if ESP® is malfunctioning</p> <p>If ESP® is malfunctioning, ESP® cannot carry out vehicle stabilization. In addition, other driving safety systems are switched off.</p> <ul style="list-style-type: none"> ► Drive on carefully. ► Have ESP® checked at a qualified specialist workshop. </div> <ul style="list-style-type: none"> ► Drive on carefully. ► Observe the messages on the multifunction display. ► Visit a qualified specialist workshop.

Warning/indicator lamp	Possible causes/consequences and ► Solutions
 <p data-bbox="194 347 443 367">ESP® OFF warning lamp</p>	<p data-bbox="508 253 1182 274">The yellow ESP® OFF warning lamp is lit while the engine is running.</p> <p data-bbox="508 284 739 305">*ESP® is deactivated.</p> <div data-bbox="535 331 1690 372" style="background-color: #f0f0f0; padding: 5px;"> <p data-bbox="545 341 1228 367">▲ WARNING Risk of skidding when driving with ESP® deactivated</p> </div> <p data-bbox="545 383 1653 435">If ESP® is deactivated, ESP® cannot carry out vehicle stabilization. The availability of further driving safety systems is also limited.</p> <ul data-bbox="545 445 1164 512" style="list-style-type: none"> <li data-bbox="545 445 766 471">► Drive on carefully. <li data-bbox="545 481 1164 512">► Only deactivate ESP® for as long as the situation requires. <p data-bbox="545 533 1071 559">If ESP® cannot be activated, ESP® is malfunctioning.</p> <ul data-bbox="545 569 1256 595" style="list-style-type: none"> <li data-bbox="545 569 1256 595">► Have ESP® checked immediately at a qualified specialist workshop. <p data-bbox="526 626 1118 652">► Observe the notes on deactivating ESP® (→ page 140).</p>
 <p data-bbox="194 761 471 787">ESP® SPORT warning lamp</p>	<p data-bbox="508 673 1034 699">ESP® SPORT is activated while the engine is running.</p> <p data-bbox="508 709 1386 735">*When ESP® SPORT is activated, ESP® will stabilize the vehicle only to a limited extent.</p> <div data-bbox="535 751 1690 792" style="background-color: #f0f0f0; padding: 5px;"> <p data-bbox="545 761 1210 787">▲ WARNING Risk of skidding if ESP® SPORT is used incorrectly</p> </div> <p data-bbox="545 802 1487 833">When you activate ESP® SPORT, there is an increased risk of skidding and having an accident.</p> <ul data-bbox="545 839 1238 865" style="list-style-type: none"> <li data-bbox="545 839 1238 865">► Activate ESP® SPORT only in the circumstances described below.



Warning/indicator lamp	Possible causes/consequences and ► Solutions
<div data-bbox="155 296 310 377" data-label="Image"> </div> <p data-bbox="144 384 408 410">Brake warning lamp (USA)</p> <div data-bbox="155 415 310 496" data-label="Image"> </div> <p data-bbox="144 503 417 553">Brakes warning lamp (Canada)</p>	<p data-bbox="476 249 1110 275">► Observe the notes on activating ESP® SPORT(→ page 140).</p> <p data-bbox="452 291 1138 317">The red brake system warning lamp is lit while the engine is running.</p> <p data-bbox="465 327 685 348">*Possible causes are:</p> <ul data-bbox="484 358 1430 420" style="list-style-type: none"> • The brake force boosting is malfunctioning and the braking characteristics may be affected. • There is not enough brake fluid in the brake fluid reservoir. <div data-bbox="484 441 1646 477" data-label="Section-Header"> <p>▲ WARNING Risk of accident and injury if brake force boosting is malfunctioning</p> </div> <p data-bbox="495 487 1622 534">If brake force boosting is malfunctioning, increased brake pedal force may be necessary for braking. The braking characteristics may be impaired. The braking distance can increase in emergency braking situations.</p> <ul data-bbox="495 544 1134 607" style="list-style-type: none"> ► Stop in a safe location immediately. Do not continue driving. ► Consult a qualified specialist workshop. <div data-bbox="484 638 1646 674" data-label="Section-Header"> <p>▲ WARNING Risk of an accident due to low brake fluid level</p> </div> <p data-bbox="495 684 1498 710">If the brake fluid level is too low, the braking effect and the braking characteristics may be impaired.</p> <ul data-bbox="495 721 1604 835" style="list-style-type: none"> ► Pull over and stop the vehicle safely as soon as possible, paying attention to road and traffic conditions. Do not continue driving under any circumstances. ► Consult a qualified specialist workshop. ► Do not add brake fluid.

Warning/indicator lamp	Possible causes/consequences and ► Solutions
	<ul style="list-style-type: none"><li data-bbox="528 249 1679 301">► Pull over and stop the vehicle safely as soon as possible, paying attention to road and traffic conditions. Do not continue driving under any circumstances.<li data-bbox="528 311 1082 337">► Observe the messages on the multifunction display.<li data-bbox="528 348 962 371">► Consult a qualified specialist workshop.



Warning/indicator lamp	Possible causes/consequences and ► Solutions
<p data-bbox="155 252 310 332"></p> <p data-bbox="144 342 426 418">Red indicator lamp, electric parking brake applied (USA only)</p> <p data-bbox="155 425 310 505"></p> <p data-bbox="144 515 426 591">Red indicator lamp, electric parking brake applied (Canada only)</p> <p data-bbox="155 598 310 678"></p> <p data-bbox="144 688 426 764">Yellow electric parking brake indicator lamp is malfunctioning</p>	<p data-bbox="452 249 1641 298">The red electric parking brake indicator lamp flashes or is lit. The yellow indicator lamp is also lit if the electric parking brake malfunctions.</p> <p data-bbox="452 308 1031 336">* ► Observe the messages on the multifunction display.</p>

Warning/indicator lamp	Possible causes/consequences and ► Solutions
 <p data-bbox="195 342 452 394">Restraint system warning lamp</p>	<p data-bbox="508 249 1215 275">The red restraint system warning lamp is lit while the engine is running.</p> <p data-bbox="508 282 962 308">*The restraint system is faulty (→ page 32).</p> <div data-bbox="532 326 1696 498"><p data-bbox="541 335 1271 361">▲ WARNING Risk of injury due to malfunctions in the restraint system</p><p data-bbox="541 376 1655 453">If the restraint system is malfunctioning, restraint system components may be triggered unintentionally or may not deploy as intended during an accident. This may affect the Emergency Tensioning Devices or airbags, for example.</p><ul data-bbox="541 464 1535 490" style="list-style-type: none"><li data-bbox="541 464 1535 490">► Have the restraint system checked and repaired immediately at a qualified specialist workshop.</div> <ul data-bbox="532 515 1086 609" style="list-style-type: none"><li data-bbox="532 515 746 541">► Drive on carefully.<li data-bbox="532 550 1086 576">► Observe the messages on the multifunction display.<li data-bbox="532 584 1086 609">► Consult a qualified specialist workshop immediately.



Seat belts



Warning/indicator lamp	Possible causes/consequences and ► Solutions
 <p data-bbox="144 384 376 433">Seat belt warning lamp lights up</p>	<p data-bbox="456 291 1332 350">The red seat belt warning lamp will light up for six seconds once the engine has started. In addition, a warning tone may sound.</p> <ul data-bbox="463 360 1400 419" style="list-style-type: none">* The seat belt warning lamp reminds the driver and front passenger to fasten their seat belts.<ul data-bbox="476 391 864 419" style="list-style-type: none">► Fasten your seat belt (→ page 36). <p data-bbox="476 436 1452 464">If you have placed objects on the front passenger seat, the seat belt warning lamp may remain lit.</p>
 <p data-bbox="144 573 376 619">Seat belt warning lamp flashes</p>	<p data-bbox="456 480 1258 505">The red seat belt warning lamp flashes and an intermittent warning tone sounds.</p> <ul data-bbox="463 515 1387 640" style="list-style-type: none">* The driver or front passenger has not fastened their seat belt while the vehicle is in motion.<ul data-bbox="476 547 864 574" style="list-style-type: none">► Fasten your seat belt(→ page 36).* There are objects on the front passenger seat.<ul data-bbox="476 616 1023 640" style="list-style-type: none">► Remove the objects from the front passenger seat.

Driving systems

Warning/indicator lamp	Possible causes/consequences and ► Solutions
 <p data-bbox="194 383 462 429">Warning lamp for distance warning function</p>	<p data-bbox="508 290 1201 315">The red distance warning lamp lights up while the vehicle is in motion.</p> <p data-bbox="508 326 1228 352">* The distance to the vehicle in front is too small for the speed selected.</p> <p data-bbox="526 357 1432 383">If there is an additional warning tone, you are approaching an obstacle at too high a speed.</p> <ul style="list-style-type: none"> <li data-bbox="526 393 905 419">► Be prepared to brake immediately. <li data-bbox="526 424 785 450">► Increase the distance. <p data-bbox="526 466 988 492">Function of Active Brake Assist (→ page 142).</p>
 <p data-bbox="194 606 452 626">Suspension warning lamp</p>	<p data-bbox="508 512 1201 538">The yellow AMG adaptive sport suspension system warning lamp is lit.</p> <p data-bbox="508 543 1219 569">* There is a malfunction in the AMG adaptive sport suspension system.</p> <ul style="list-style-type: none"> <li data-bbox="526 580 1044 606">► Note the messages on the multifunction display.

Engine

Warning/indicator lamp	Possible causes/consequences and ► Solutions
 <p data-bbox="144 384 402 433">Engine diagnosis warning lamp</p>	<p data-bbox="452 288 1171 313">The yellow Check Engine warning lamp is lit while the engine is running.</p> <p data-bbox="465 324 1288 350">* A malfunction has occurred in the engine, the exhaust system or the fuel system.</p> <p data-bbox="478 360 1350 386">The emission limit values may be exceeded and the engine may be in emergency mode.</p> <p data-bbox="478 396 1609 443">In some states, legal requirements stipulate that you must immediately consult a qualified specialist workshop as soon as the yellow Check Engine warning lamp lights up.</p> <ul style="list-style-type: none"> <li data-bbox="478 453 1313 479">► Have the vehicle checked as soon as possible at a qualified specialist workshop.
 <p data-bbox="144 591 426 640">Electrical malfunction warning lamp</p>	<p data-bbox="452 495 949 521">The red electrical malfunction warning lamp is lit.</p> <p data-bbox="465 531 861 557">* There is a malfunction in the electrics.</p> <ul style="list-style-type: none"> <li data-bbox="478 567 1031 593">► Observe the messages on the multifunction display.
 <p data-bbox="144 750 408 775">Fuel reserve warning lamp</p>	<p data-bbox="452 653 1153 679">The yellow fuel reserve warning lamp is lit while the engine is running.</p> <p data-bbox="465 689 994 715">* The fuel supply has dropped into the reserve range.</p> <ul style="list-style-type: none"> <li data-bbox="478 726 583 752">► Refuel.

Warning/indicator lamp	Possible causes/consequences and ► Solutions
 <p data-bbox="195 342 462 366">Fuel reserve warning lamp</p>	<p data-bbox="504 249 1105 273">The yellow fuel reserve warning lamp lights up while driving.</p> <p data-bbox="504 283 1683 335">*There has been pressure loss in the fuel system. The fuel filler cap is not closed correctly or the fuel system is leaking.</p> <p data-bbox="524 346 802 369">► Close the fuel filler cap.</p> <p data-bbox="524 394 1066 418">If the fuel filler cap has already been closed correctly:</p> <p data-bbox="524 428 929 452">► Visit a qualified specialist workshop.</p>
 <p data-bbox="195 562 415 586">Coolant warning lamp</p>	<p data-bbox="504 472 1129 496">The red coolant warning lamp is lit while the engine is running.</p> <p data-bbox="504 506 735 530">*Possible causes are:</p> <ul data-bbox="534 540 990 667" style="list-style-type: none"> <li data-bbox="534 540 981 564">• The temperature sensor is malfunctioning <li data-bbox="534 574 835 598">• The coolant level is too low <li data-bbox="534 609 990 632">• The air supply to the radiator is obstructed <li data-bbox="534 643 809 667">• The radiator fan is faulty <p data-bbox="524 681 1692 705">If there is an additional warning tone, the coolant temperature has exceeded the maximum permissible temperature.</p> <div data-bbox="537 726 1696 767" style="background-color: #e0e0e0; padding: 5px;"> <p data-bbox="543 736 1105 760">⚠ WARNING Danger of burns when opening the hood</p> </div> <p data-bbox="543 775 1624 827">If you open the hood when the engine has overheated or during a fire in the engine compartment, you could come into contact with hot gases or other escaping operating fluids.</p> <p data-bbox="543 838 1147 861">► Before opening the hood, allow the engine to cool down.</p>

Warning/indicator lamp	Possible causes/consequences and ► Solutions
	<ul style="list-style-type: none"><li data-bbox="482 256 1644 288">▶ In the event of a fire in the engine compartment, keep the hood closed and call the fire service.<li data-bbox="482 308 1644 360">▶ Pull over and stop the vehicle safely and switch off the engine, paying attention to road and traffic conditions. Do not continue driving under any circumstances.<li data-bbox="482 370 1644 401">▶ Observe the messages on the multifunction display. <p data-bbox="482 412 1644 443">If the coolant temperature display is at the lower end of the temperature scale:</p> <ul style="list-style-type: none"><li data-bbox="482 448 1644 479">▶ Consult a qualified specialist workshop. <p data-bbox="482 484 1644 515">or</p> <ul style="list-style-type: none"><li data-bbox="482 521 1644 552">▶ Exit the vehicle and keep a safe distance from it until the engine has cooled down.<li data-bbox="482 557 1644 588">▶ Check the coolant level (→ page 300).<li data-bbox="482 593 1644 624">▶ Make sure that the air supply to the radiator is not obstructed.<li data-bbox="482 629 1644 671">▶ Avoiding high loads on the engine, drive to the nearest qualified specialist workshop. In doing so, ensure that the coolant temperature display remains below the red area.

Tires

Warning/indicator lamp	Possible causes/consequences and ► Solutions
 <p data-bbox="194 383 471 461">Tire pressure monitoring system warning lamp lights up</p>	<p data-bbox="508 290 1413 315">The yellow tire pressure monitoring system warning lamp (pressure loss/malfunction) is lit.</p> <p data-bbox="508 321 1469 347">*The tire pressure monitoring system has detected tire pressure loss in at least one of the tires.</p> <div data-bbox="526 367 1690 668" style="border: 1px solid gray; padding: 5px;"> <p data-bbox="545 378 1210 404">▲ WARNING Risk of an accident due to insufficient tire pressure</p> <p data-bbox="545 414 1127 440">Tire pressures that are too low pose the following hazards:</p> <ul data-bbox="554 450 1450 543" style="list-style-type: none"> • The tires may burst, especially as the load and vehicle speed increase. • The tires may wear excessively and/or unevenly, which may greatly impair tire traction. • The driving characteristics, as well as steering and braking, may be greatly impaired. <p data-bbox="545 559 960 585">You could then lose control of the vehicle.</p> <ul data-bbox="545 595 988 657" style="list-style-type: none"> ► Observe the recommended tire pressure. ► Adjust the tire pressure if necessary. </div> <ul data-bbox="526 678 1201 740" style="list-style-type: none"> ► Stop the vehicle, paying attention to road and traffic conditions. ► Check the tire pressure and the tires.

430 Display messages and warning/indicator lamps

Warning/indicator lamp	Possible causes/consequences and ► Solutions
 <p data-bbox="144 342 395 415">Tire pressure monitoring system warning lamp flashes</p>	<p data-bbox="452 249 1613 298">The yellow tire pressure monitoring system warning lamp (pressure loss/malfunction) flashes for approximately one minute and then remains lit.</p> <p data-bbox="465 309 966 334">*The tire pressure monitoring system is defective.</p> <div data-bbox="482 353 1646 532" style="border: 1px solid gray; padding: 5px;"><p data-bbox="493 360 1502 385">▲ WARNING There is a risk of an accident if the tire pressure monitoring system is malfunctioning</p><p data-bbox="493 401 1613 450">If the tire pressure monitoring system is malfunctioning, it is not able to issue a warning if there is pressure loss in one or more of the tires.</p><p data-bbox="493 462 1424 486">Underinflated tires may, for example, impair the driving, steering and braking characteristics.</p><p data-bbox="493 498 1378 523">► Have the tire pressure monitoring system checked at a qualified specialist workshop.</p></div> <p data-bbox="476 547 879 571">► Visit a qualified specialist workshop.</p>

Vehicle

Warning/indicator lamp	Possible causes/consequences and ► Solutions
 <p data-bbox="144 811 395 859">Warning lamp for electric power steering</p>	<p data-bbox="452 717 1267 742">The red warning lamp for electric power steering is lit while the engine is running.</p> <p data-bbox="465 754 1151 779">*The power-assisted steering or the steering itself is malfunctioning.</p> <div data-bbox="482 797 1646 871" style="border: 1px solid gray; padding: 5px;"><p data-bbox="493 804 1138 829">▲ WARNING Risk of accident if steering capability is impaired</p><p data-bbox="493 841 1397 866">If the steering does not function as intended, the vehicle's operating safety is jeopardized.</p></div>

Warning/indicator lamp	Possible causes/consequences and ► Solutions
	<ul style="list-style-type: none"><li data-bbox="545 253 1663 305">▶ Pull over and stop the vehicle safely as soon as possible, paying attention to road and traffic conditions. Do not continue driving under any circumstances.<li data-bbox="545 315 979 347">▶ Consult a qualified specialist workshop. <p data-bbox="526 367 1044 398">▶ Note the messages on the multifunction display.</p>

1, 2, 3 ...

12 V battery

see Battery (vehicle)

A**A/C function**

Switching on/off (control panel) 105

ABS (Anti-lock Braking System) 139**Acceleration**

see Kickdown

Accident and breakdown management

Mercedes me connect 264

Acoustic locking verification signal

Activating/deactivating 55

Activating/deactivating automatic volume adjustment

Burmester® surround sound system ... 293

Active aerodynamics profile

Care 307

Active Blind Spot Assist

Switching on/off 167

Active Brake Assist

Function/notes 142

Setting 145

Active Distance Assist DISTRONIC 147

Calling up a speed 148

Displays in the Instrument Display 150

Function 147

Increasing/decreasing speed 148

Requirements 148

Steering wheel buttons 148

Storing a speed 148

Switching off/deactivating 148

Switching on/activating 148

System limitations 147

Active Service System PLUS

see ASSYST PLUS

Adaptive

see Lane Keeping Assist

Adaptive cruise control

see Active Distance Assist DISTRONIC

Adaptive Highbeam Assist

Function 97

Switching on/off 98

Additional value range

Setting display content 172

Additives 365

Engine oil 365

Fuel 364

Additives (engine oil)

see Additives

Additives (fuel)

see Fuel

Address book

see Contacts

Adjusting the balance

Burmester® high-end Surround

sound system 294

Burmester® surround sound system ... 293

Adjusting the bass, mid-range and treble

Burmester® high-end Surround

sound system 294

Adjusting the mid-range, treble and bass

Burmester® high-end Surround

sound system 294

- Adjusting the sound optimization**
 - Burmester® high-end Surround sound system 294
- Adjusting treble, mid-range and bass settings**
 - Burmester® high-end Surround sound system 294
 - Burmester® surround sound system ... 293
- Aerodynamics**
 - Active aerodynamics profile 120
 - Rear wing 120
- Aerodynamics profile** 156
 - Function/notes 156
 - Retracting/extending 156
- After-sales service center**
 - see ASSYST PLUS
- Air bag**
 - Reduced protection 40
- Air inlet**
 - see Air-water duct
- Air pressure**
 - see Tire pressure
- Air vents** 107
 - Adjusting (front) 107
 - Adjusting the AIRSCARF vents 108
- Air vents**
 - see Air vents
- Air-recirculation mode** 107
- Air-water duct** 302
 - Keeping free 302
- Airbag** 38
 - Activation 32
 - Front airbag 38
 - Head airbag 38
 - Installation locations 38
 - Knee airbag 38
 - Overview 38
 - PASSENGER AIR BAG indicator lamp 43
 - Protection 39
 - Side airbag 38
- AIRSCARF**
 - Activating/deactivating 83
 - Adjusting the outlets 108
- Alarm**
 - see Panic alarm
- Alarm system**
 - see ATA (anti-theft alarm system)
- Alternative route**
 - see Route
- AMG**
 - Steering wheel control element 155
 - Steering-wheel buttons 155
- AMG adaptive sport suspension system**
 - Selecting the suspension setting 157
 - Suspension 157
- AMG ceramic high-performance composite brake system** 115
- AMG Performance adjustable exhaust system** 116
 - Function 116
 - Operating 116
- AMG performance seat**
 - Setting 80
- AMG Performance steering wheel** 155
- AMG TRACK PACE**
 - Configuring 219
 - Drag Race 218

- General information 216
- Telemetry display 219
- Track Race 217
- Android Auto** 259
 - Connecting a mobile phone 260
 - Ending 260
 - Information 260
 - Overview 259
 - Sound settings 260
 - Transferred vehicle data 261
- Animals**
 - Pets in the vehicle 52
- Anti-lock braking system**
 - see ABS (Anti-lock Braking System)
- Anti-skid chains**
 - see Snow chains
- Anti-theft alarm system**
 - see ATA (anti-theft alarm system)
- Anti-theft protection**
 - Immobilizer 75
- Anticipatory occupant protection**
 - see PRE-SAFE® (anticipatory occupant protection)
- Apple CarPlay®** 257
 - Connecting an iPhone® 258
 - Ending 259
 - Notes 258
 - Overview 257
 - Sound settings 259
 - Transferred vehicle data 261
- Ashtray**
 - Front center console 91
- Assistance**
 - Menu (on-board computer) 174
- Assistance systems**
 - see Driving safety system
- ASSYST PLUS** 295
 - Battery disconnection periods 296
 - Displaying the service due date 295
 - Function/notes 295
 - Regular maintenance work 295
 - Special service requirements 295
- ATA (anti-theft alarm system)** 75
 - Deactivating the alarm 76
 - Function 75
- ATTENTION ASSIST** 163, 164
 - Function 163
 - Setting 164
 - System limitations 163
- Attention assistant**
 - see ATTENTION ASSIST
- Audio mode**
 - Activating media mode 275
 - Connecting USB devices 276
 - Copyrights 275
 - Information 273
 - Inserting/removing an SD card 275
 - Media search 280
 - Overview 276
 - Pause and playback function 277
 - Selecting a track 277
 - Selecting playback options 277
 - Track list 277
- Authorized Mercedes-Benz Center**
 - see Qualified specialist workshop
- Authorized workshop**
 - see Qualified specialist workshop
- Automatic distance control**
 - see Active Distance Assist DISTRONIC
- Automatic driving lights** 96

Automatic engine start (ECO start/stop function)	115
Automatic engine stop (ECO start/stop function)	115
Automatic front passenger front airbag shutoff	41, 43
Function of the automatic front passenger front airbag shutoff	41
PASSENGER AIR BAG indicator lamp	43
Automatic front passenger front airbag shutoff	
see Automatic front passenger front airbag shutoff	
Automatic mirror folding function	
Activating/deactivating	104
Automatic transmission	
Double-clutch function	125
Drive program display	122
Drive programs	121
DYNAMIC SELECT switch	121
E-SELECT selector lever	123
Engaging drive position	125
Engaging neutral	124
Engaging park position	125

Engaging reverse gear	124
Kickdown	127
Manual gearshifting	126
Oil temperature (on-board computer, Performance menu)	174
Steering wheel paddle shifters	126
Transmission position display	123
Transmission positions	123

B

BAS (Brake Assist System)	139
Battery	
SmartKey	56
Battery	
see Battery (vehicle)	
Battery (vehicle)	323
Charging	322
Notes	318
Notes (starting assistance and charging)	320
Replacing	323
Starting assistance	322
Belt	
see Seat belt	

Blind Spot Assist	166
Function	166
Switching on/off	167
System limitations	166
Bluetooth®	208
Activating/deactivating	208
Information	207
Bluetooth® audio	
Activating	284
De-authorizing (de-registering) the device	285
Information	282
Overview	283
Searching for a track	285
Searching for and authorizing the device	283
Selecting a media player	284
Boost pressure (on-board computer, Performance menu)	174
Brake Assist System	
see BAS (Brake Assist System)	
Brake fluid	
Notes	365

Brake force distribution

EBD (electronic brake force distribution) 142

Brake system

ABS 118
 Brake caliper 119
 Brake cooling 119
 Brake discs 118
 Brake fluid 118
 Brake hose 119
 Brake line 119
 Brake pads 118
 Notes 118

Brakes

ABS (Anti-lock Braking System) 139
 Active Brake Assist 142
 AMG ceramic high-performance composite brake system 115
 BAS (Brake Assist System) 139
 Driving tips 112
 EBD (electronic brake force distribution) 142
 HOLD function 151
 Limited braking effect (salt-treated roads) 112

New/replaced brakepads/brake discs 111
 Notes on breaking-in a new vehicle 111

Braking assistance

see BAS (Brake Assist System)

Breakdown

Changing a wheel 354
 Overview of the help functions 16
 Roadside Assistance 21
 Tow-starting 327
 Towing away 325
 Transporting the vehicle 326

Breakdown

see Flat tire

Burmester® high-end Surround sound system

Adjusting the balance 294
 Adjusting the sound optimization 294
 Adjusting treble, mid-range and bass settings 294
 Automatic volume adjustment 294
 Calling up the sound menu 293
 Information 293
 Selecting the sound profile 294

Burmester® surround sound system 292

Adjusting the balance 293
 Adjusting treble, mid-range and bass settings 293
 Automatic volume adjustment 293
 Calling up the sound menu 292
 Information 292
 Switching the surround sound on/off 293

Buttons

Steering wheel 170

C**Call list**

Making a call 255
 Overview 254

Calling up the sound menu

Burmester® high-end Surround sound system 293
 Burmester® surround sound system ... 292

Calls 251

Accepting 251
 Activating functions during a call 251
 Calls with several participants 251

- Declining 251
- Ending a call 251
- Incoming call during an existing call 252
- Making 251
- Mercedes me 261
- Camera**
 - see Rear view camera
- Car key**
 - see SmartKey
- Car wash**
 - see Care
- Car wash (care)** 302
- Care** 310
 - Active aerodynamics profile 307
 - Air-water duct 302
 - Automatic car wash 302
 - Carpet 310
 - Decorative foil 305
 - Display 310
 - Exterior lighting 307
 - Headliner 310
 - Matte finish 304
 - Paintwork 304
 - Plastic trim 310
 - Power washer 303
 - Real wood/trim elements 310
 - Rear view camera 307
 - Seat belt 310
 - Seat cover 310
 - Sensors 307
 - Soft top 307
 - Tailpipes 307
 - Washing by hand 303
 - Wheels/rims 307
 - Windows 307
 - Wiper blades 307
- Carpet (Care)** 310
- Change of address** 21
- Change of ownership** 21
- Changing a wheel**
 - Installing/removing plastic hub caps .. 354
 - Preparation 354
 - Raising the vehicle 355
- Changing gears** 126
 - Manually 126
- Character entry**
 - On the touchpad 205
- Charging**
 - Battery (vehicle) 322
- Child safety lock**
 - Activating/deactivating (multimedia system) 211
- Child seat**
 - Attaching (notes) 50
 - Basic instructions 46
 - Front-passenger seat (notes) 51
 - Notes on risks and dangers 47
 - Securing on the front passenger seat 52
- Children**
 - Avoiding dangers in the vehicle 47
 - Basic instructions 46
 - Special seat belt retractor 50
- Chock** 353
 - Storage location 353
- Chock**
 - see Chock
- Cigarette lighter**
 - Front center console 92
- Cleaning**
 - see Care

Climate control

Activating/deactivating	105
Activating/deactivating the A/C function (control panel)	105
Activating/deactivating the synchro- nization function (control panel)	106
Air distribution settings	106
Air-recirculation mode	107
Automatic control	106
Climate style function	106
Control panel for 3-zone automatic climate control	105
Filling capacity for PAG oil	368
Front air vents	107
Note	105
Refrigerant	367
Refrigerant filling capacity	368
Removing condensation from the windows	106
Setting the climate style	106
Ventilating the vehicle (convenience opening)	72
Climate style	
Function	106
Setting	106

Cockpit	6
Overview	6
Coffee cup symbol see ATTENTION ASSIST	
COMAND see Multimedia system	
COMAND Touch Managing devices	210
Combination switch	96
Compass	244
Computer see On-board computer	
Connection status Displaying	269
Overview	269
Contacts	252
Calling up	253
Deleting	254
Downloading (from mobile phone)	252
Importing	253
Importing (overview)	253
Information	252
Making a call	254

Name format	253
Options	254
Storing	254

Controller

Operating	199
-----------------	-----

Convenience closing feature**Convenience opening****Cool down laps****Coolant (engine)**

Capacity	367
Check level	300
Notes	366

















Copyright























Licenses	29
Trademarks	29

















Cruise control





Buttons	146
Calling up a speed	146
Function	145
Requirements:	146
Selecting	146
Setting a speed	146
Storing a speed	146

- Switching off 146
 - Switching on 146
 - System limitations 145
 - Cup holder** 90
 - Installing/removing (center console) 90
 - Customer Assistance Center (CAC)** 25
 - Customer Relations Department** 25
- D**
- Dashboard**
 - see Cockpit
 - Dashboard lighting**
 - see Instrument cluster lighting
 - Data acquisition**
 - Vehicle 26
 - Data import/export** 211
 - Function/notes 211
 - Importing/exporting 212
 - Data storage**
 - Electronic control units 26
 - Online services 28
 - Vehicle 26
 - Date**
 - Setting the time and date automati-
cally 206
 - Deactivating the alarm (ATA)** 76
 - Dealership**
 - see Qualified specialist workshop
 - Declaration of conformity**
 - Wireless vehicle components 23
 - Decorative foil (cleaning instructions)** 305
 - Definitions (tires and loading)** 347
 - Designs**
 - Menu (on-board computer) 172
 - Destination** 236
 - Editing intermediate destinations 226
 - Editing the previous destinations 237
 - External 237
 - Saving (current vehicle position) 236
 - Saving as global favorite 237
 - Storing a map position 236
 - Destination entry** 222
 - Entering 3 word addresses 227
 - Entering a POI or address 222
 - Entering an intermediate destination .. 226
 - Entering geo-coordinates 227
 - Selecting a contact 226
 - Selecting a POI 224
 - Selecting from the map 228
 - Selecting previous destinations 224
 - Detecting inattentiveness**
 - see ATTENTION ASSIST
 - Diagnostics connection** 23
 - Digital Operator's Manual** 18
 - Digital speedometer** 177
 - Dinghy towing**
 - see Tow-bar system
 - Display**
 - Care 310
 - Display (multimedia system)**
 - Settings 206
 - Display (on-board computer)**
 - Displays on the multifunction display .. 173
 - Display content**
 - Setting the additional value range 172

- Display message** 371
- Calling up (on-board computer) 371
 - Notes 371
- Display messages**
-  --- mph 390
 -  --- mph 389
 -  12 V Battery See Operator's Manual 393
 -  12 V Battery See Operator's Manual 413
 - Active Brake Assist Functions Currently Limited See Operator's Manual 385
 - Active Brake Assist Functions Limited See Operator's Manual 385
 - Active Distance Assist Currently Unavailable See Operator's Manual 390
 - Active Distance Assist Inoperative 390
 - Active Distance Assist Now Available 390
 - Adaptive Highbeam Assist Camera View Restricted See Operator's Manual 415
 - Adaptive Highbeam Assist Currently Unavailable See Operator's Manual 415
 - Adaptive Highbeam Assist Inoperative 415
 - Apply Brake to Shift from 'P' 397
 - Apply Brake to Shift to 'R' 397
 -  ATTENTION ASSIST Inoperative ... 387
 -  ATTENTION ASSIST: Take a Break! 387
 -  Automatic Headlamp Mode Inoperative 414
 - Auxiliary Battery Malfunction 399
 - Blind Spot Assist Currently Unavailable See Operator's Manual 387
 - Blind Spot Assist Inoperative 388
 -  BRAKE Check Brake Fluid Level 381
 - Check Brake Pads See Operator's Manual 381
 -  Check Coolant Level See Operator's Manual 391
 -  Check Engine Oil Level (Add 1 quart) 395
 -  Check Left Low Beam (Example) 413
 -  Check Tires 401
 -  Check Washer Fluid 411
 -  Convertible Top Lowering 412
 -  Convertible Top Operation Possible to 37 mph 412
 -  Coolant Too Hot Stop Vehicle Turn Engine Off 392
 - Cruise Control Inoperative 390
 - Cruise Control Off 391
 -  Currently Unavailable See Operator's Manual 372

-  Currently Unavailable See Operator's Manual 373
- Decrease Speed 403
-  Don't Forget Your Key 405
- Driver's Door Open & Transmission Not in P Risk of Vehicle Rolling Away ... 397
- Electronic Rear Axle Differential Lock Currently Unavailable 408
- Electronic Rear Axle Differential Lock Inoperative 408
-  Engine Oil Level Cannot Be Measured 396
-  Engine Oil Reduce Oil Level 396
-  Front Left Malfunction Service Required (example) 382
- Front Passenger Airbag Disabled See Operator's Manual 383
- Front Passenger Airbag Enabled See Operator's Manual 384
-  Fuel Level Low 395
-  Gas Cap Loose 395
- Hazard Warning Flashers Malfunctioning 415
-  Inoperative See Operator's Manual 373
-  Inoperative See Operator's Manual 374
-  Inoperative See Operator's Manual 375
-  Inoperative 386
-  Insert Key 405
-  Key Not Detected (red display message) 405
-  Key Not Detected (white display message) 404
-  Malfunction Drive at Max. 50 mph 387
-  Malfunction See Operator's Manual 414
- Mercedes me connect Services Limited See Operator's Manual 385
- N Permanently Active Risk of Rolling Away 398
-  Obtain a New Key 404
-  Off 390
-  Off 389
- Only Shift to 'P' when Vehicle is Stationary 397
-  Open/Close Convertible Top Completely 413
-  Parking Brake See Operator's Manual 378
-  Please Correct Tire Pressure 402
-  Please Release Parking Brake 377
- PRE-SAFE Inoperative See Operator's Manual 385
- RACE START Canceled 391
- RACE START Not Possible See Operator's Manual 391

- Radar Sensors Dirty See Operator's Manual 386
 Rear Axle Steering Currently Unavailable 408
 Rear Axle Steering Malfunction Service Required 407
 Rear Spoiler Control System Inoperative 409
 Rear Spoiler Inoperative Limit ### mph 410
 Replace Key Battery 404
 Reversing Not Possible Service Required 398
 See Operator's Manual 393
 Service Required Do Not Shift Gears Visit Dealer 398
 Spoilers Extended Caution, Reduced Ground Clearance 409
 SRS Malfunction Service Required 382
 Steering Malfunction Increased Physical Effort See Operator's Manual 406
 Steering Malfunction Stop Immediately See Operator's Manual 407
 Stop Vehicle Leave Engine Running Wait Transmission Cooling 399
 Stop Vehicle Leave Engine Running 394
 Stop Vehicle See Operator's Manual 394
 Suspended 389
 Switch Off Lights 414
 Switch On Headlamps 414
 Tire Press. Monitor Currently Unavailable 400
 Tire Press. Monitor Inoperative 400
 Tire Pressure Monitor Inoperative No Wheel Sensors 401
 Tires Overheated 403
 To Deselect P or N, Depress Brake and Start Engine 397
 To switch engine off, press and hold Start/Stop button for at least 3 secs. or press 3 times. 393
 Traction Control Inoperative See Operator's Manual 408
 Traffic Sign Assist Camera View Restricted See Operator's Manual 388
 Traffic Sign Assist Currently Unavailable See Operator's Manual 388
 Traffic Sign Assist Inoperative 388
 Trans. Oil Overheated Drive on with Care 400
 Transmission Malfunction Stop 398
 Transmission Oil Cooling Malfunction 399
 Turn On the Ignition to Release the Parking Brake 376

-  Vehicle Ready to Drive Switch
the Ignition Off Before Exiting 406
-  Warning Tire Malfunction 402
-  Wheel Sensor(s) Missing 401
-  While stationary, apply the
brakes before operating the soft top. ... 412
- Distance control**
see Active Distance Assist DISTRONIC
- Distance recorder**
see Trip distance
- DISTRONIC**
see Active Distance Assist DISTRONIC
- Door**
 - Locking (emergency key) 62
 - Opening (from the inside) 59
 - Unlocking (emergency key) 62
 - Unlocking (from the inside) 59
- Door control panel** 14
- DOT, Tire Identification Number (TIN)** ... 343
- Double-clutch function** 125
- Drag Race**
 - Setting 218
- Drawbar**
see Tow-bar system
- Drinking and driving** 112
- Drinks holder**
see Cup holder
- Drive position**
 - Engaging 125
- Drive program display** 122
- Drive programs**
see DYNAMIC SELECT
- Driver's seat**
see Seat
- Driving lights**
see Automatic driving lights
- Driving safety system** 138
 - ABS (Anti-lock Braking System) 139
 - Active Brake Assist 142
 - BAS (Brake Assist System) 139
 - EBD (electronic brake force distribu-
tion) 142
 - ESP® (Electronic Stability Program) 140
 - Overview 139
 - Radar and ultrasonic sensors 138
 - Responsibility 138
- Driving system**
AMG adaptive sport suspension sys-
tem 157
- Driving system**
see Active Distance Assist DISTRONIC
see ATTENTION ASSIST
see Blind Spot Assist
see Cruise control
see Driving safety system
see HOLD function
see Lane Keeping Assist
see Parking Assist PARKTRONIC
see Rear view camera
see Traffic Sign Assist
- Driving tips**
 - AMG ceramic high-performance
composite brake system 115
 - Drinking and driving 112
 - General driving tips 112
 - Notes on breaking-in a new vehicle 111

- Drowsiness detection**
 see ATTENTION ASSIST
- DYNAMIC SELECT** 121
 Configuring drive program I 123
 Displaying engine data 123
 Displaying vehicle data 123
 Drive program display 122
 Drive programs 121
 Function 121
 Operating (DYNAMIC SELECT switch)
 122
 Selecting the drive program 122
 Showing operation feedback 123
- E**
- E-SELECT selector lever** 123
 Engaging drive position 125
 Engaging neutral 124
 Engaging park position 125
 Engaging park position automatically .. 125
 Engaging reverse gear 124
 Function 123
- E10** 363
- Easy entry feature**
 Function/notes 86
 Setting 87
- Easy exit feature**
 Function/notes 86
 Setting 87
- EBD (electronic brake force distribution)**
 Function/notes 142
- ECO start/stop function** 115
 Automatic engine start 115
 Automatic engine stop 115
 Method of operation 115
 Switching off/on 116
- Electric parking brake** 136
 Applying automatically 136
 Applying or releasing manually 137
 Emergency braking 138
 Releasing automatically 137
- Emergency**
 Overview of the help functions 16
 Reflective safety vest 312
- Emergency braking** 138
- Emergency braking**
 see BAS (Brake Assist System)
- Emergency call system**
 see Mercedes-Benz emergency call system
- Emergency engine start** 327
- Emergency key**
 Locking a door 62
 Unlocking a door 62
- Emergency release**
 Trunk lid (from inside) 66
- Emergency Tensioning Devices**
 Activation 32
- Emotion Start**
 Starting the vehicle 110
- Engine**
 ECO start/stop function 115
 Engine number 360
 Starting (SmartKey) 111
 Starting (start/stop button) 110
 Starting assistance 322
 Switching off (start/stop button) 130
- Engine data**
 Displaying 123

- Engine number** 360
- Engine oil** 299
- Additives 365
 - Capacity 365
 - Checking the oil level using the oil dipstick 298
 - MB-Freigabe or MB-Approval 365
 - Notes 121
 - Quality 365
 - Temperature (on-board computer, Performance menu) 174
 - Topping up 299
- Entering characters** 204
- Function/notes 204
- ESP® (Electronic Stability Program)**
- Activating/deactivating 142
 - ESP® SPORT 140
 - Function/notes 140
 - Status display (on-board computer, Performance menu) 174
- ESP® SPORT**
- Function/notes 140
- Exterior lighting**
- Care 307
- Exterior lighting**
- see Lights
- Exterior mirrors** 101, 102
- Anti-glare mode (automatic) 102
 - Automatic mirror folding function 104
 - Folding in/out 101
 - Operating the memory function 87
 - Parking position 103
 - Setting 101
- External device**
- Locking (child safety lock) 211
- F**
- Fatigue detection**
- see ATTENTION ASSIST
- Favorites**
- Adding 202
 - Calling up 202
 - Deleting 203
 - Moving 203
 - Overview 202
 - Renaming 202
- Flat tire** 312
- Changing a wheel 354
- MOExtended tires 313
- Notes 312
- TIREFIT kit 314
- Flat towing**
- see Tow-bar system
- Floor mats** 93
- Foil covering**
- Radar and ultrasonic sensors 138
- Free software** 29
- Frequency band**
- Dialing (on-board computer) 180
- Front airbag** 38
- Front and rear view camera** 161
- Front camera**
- Function 161
- Front passenger seat**
- see Seat
- Front spoiler**
- see Aerodynamics profile
- Fuel** 364
- Additives 364
 - E10 363

- Fuel reserve 364
 - Gasoline 363
 - Quality (gasoline) 363
 - Refueling 127
 - Sulfur content 363
 - Tank content 364
 - Fuel consumption**
 - On-board computer 177
 - Function seat**
 - see Door control panel
 - Fuses** 328
 - Before replacing a fuse 328
 - Fuse assignment diagram 328
 - Fuse box in the front-passenger footwell 328
 - Fuse box in the trunk 329
 - Notes 328
 - Fuses**
 - see Fuses
- G**
- G-meter (on-board computer, Performance menu)** 174
- Garage door opener**
- Clearing the memory 134
 - Opening or closing the door 134
 - Programming buttons 131
 - Radio equipment approval numbers 134
 - Resolving problems 133
 - Synchronizing the rolling code 133
- Gas station search**
- Starting automatic search 225
 - Switching automatic search on/off 231
 - Using automatic search 231
- Gasoline** 363
- Gear display (on-board computer, Performance menu)** 174
- Gearshift recommendation** 126
- Genuine parts** 19
- Glide mode** 127
- Glove box**
- Locking/unlocking 90
- H**
- Handbrake**
- see Electric parking brake
- Handling characteristics (unusual)** 330
- HANDS-FREE ACCESS** 64
- Hazard warning lights** 97
- Hazardous substances**
- Information 22
- Head airbag** 38
- Head level heating (AIRSCARF)** 83
- Head restraint**
- Front (adjusting mechanically) 81
- Headliner (care)** 310
- High beam**
- Switching on/off 96
- High-beam flasher** 96
- High-beam headlamps**
- Adaptive Highbeam Assist 97
- Hill start assist** 151
- HOLD function** 151
- Function/notes 151
 - Switching on/off 151
- Hood**
- Opening/closing 296

- Hotspot**
 Setting up (Wi-Fi) 209
- I**
- Identification plate**
 Engine 360
 Refrigerant 367
 Vehicle 360
- Ignition**
 Switching on (Start/Stop button) 109
- Ignition key**
 see SmartKey
- Immobilizer** 75
- Indicator lamps**
 see Warning/indicator lamps
- Individual drive program**
 Configuring 123
 Selecting 122
- Inside rearview mirror**
 see Exterior mirrors
- Inspection**
 see ASSYST PLUS
- Instrument cluster**
 see Instrument Display
- Instrument cluster lighting** 173
- Instrument Display** 169
 Adjusting the lighting 173
 Function/notes 169
 Instrument cluster 10
 Setting the additional value range 172
 Warning/indicator lamps 416
- Intelligent Light System**
 Adaptive Highbeam Assist 97
- Interior lighting** 99
 Reading light 99
 Setting 99
 Switch-off delay time 99
- Intermediate destination**
 Calculating a route with intermediate destinations 226
 Entering 226
 Modifying 226
 Starting an automatic gas station search 225
 Starting the automatic service station search 231
- Internet**
 Calling up a web page 270
 Closing the browser 271
 Deleting a bookmark 271
 Deleting browser data 271
 Managing bookmarks 271
- Internet connection**
 Communication module function 268
 Connection status 269
 Displaying the connection status 269
 Establishing 268
 Information 267
 Restrictions 267
- Internet radio**
 Calling up 272
 Deleting stations 272
 Logging out 273
 Overview 272
 Registering 273
 Saving stations 272
 Selecting and connecting to a station 272
 Selecting stream 273
 Setting options 273
 Terms of use 273

iPhone®

- see Apple CarPlay®
- see Mercedes-Benz Link

J**Jack**

- Storage location 353

Jump-start connection

- General notes 320

K**KEYLESS-GO**

- Locking the vehicle 59
- Problem 61
- Unlocking setting 55
- Unlocking the vehicle 59

Kickdown

- Using 127

Knee airbag

- 38

L**Labeling (tires)**

- see Tire labeling

Lamp

- see Interior lighting

Lamps (Instrument Display)

- see Warning/indicator lamps

Lane detection (automatic)

- see Lane Keeping Assist

Lane Keeping Assist 167, 168

- Function 167
- Sensitivity 168
- System limitations 167

Language 211

- Notes 211
- Setting 211

Light switch

- Overview 95

Lighting

- see Interior lighting
- see Lights

Lights 95

- Adaptive Highbeam Assist 97
- Adjusting the instrument lighting 173
- Automatic driving lights 96
- Combination switch 96

Hazard warning lights 97

High beam 96

High-beam flasher 96

Light switch 95

Low-beam headlamps 95

Parking lights 95

Rear fog lamp 95

Responsibility for lighting systems 95

Setting the exterior lighting switch-

off delay time 99

Setting the surround lighting 99

Standing lights 95

Turn signals 96

Limited Warranty

- Vehicle 26

Live Traffic Information

Displaying subscription information 238

Displaying the traffic map 238

Displaying traffic incidents 239

Extending a subscription 238

Issuing hazard alerts 240

Load index (tires) 345**Load-bearing capacity (tires)** 345

- Loading**
 - Definitions 347
 - Notes 88
 - Loading guidelines** 88
 - Loading information table** 338
 - Loads**
 - Securing 88
 - Locator lighting**
 - see Surround lighting
 - Locking/unlocking**
 - Activating/deactivating the automatic locking feature 61
 - Emergency key 62
 - KEYLESS-GO 59
 - Unlocking and opening doors from the inside 59
 - Low-beam headlamps**
 - Switching on/off 95
 - Lubricant additives**
 - see Additives
 - Luggage**
 - Securing 88
 - Lumbar support**
 - see Lumbar support (4-way)
 - Lumbar support (4-way)** 80
- M**
- Maintenance**
 - Menu (on-board computer) 173
 - Vehicle 21
 - Maintenance**
 - see ASSYST PLUS
 - Malfunction**
 - Restraint system 32
 - Malfunction message**
 - see Display message
 - Map** 238, 240, 241
 - Avoiding an area 243
 - Avoiding an area (overview) 242
 - Changing an area 243
 - Deleting an area 243
 - Displaying the compass 244
 - Displaying the map version 242
 - Displaying the next intersecting street 242
 - Displaying the satellite map 245
 - Displaying the traffic map 238
 - Displaying weather information 245
 - Map data 244
 - Moving 241
 - Overview 240
 - Selecting POI symbols 241
 - Selecting text information 242
 - Selecting the map orientation 241
 - Setting the map scale 241
 - Setting the map scale automatically 244
 - Updating 243
 - Map and compass**
 - Overview 240
 - Matte finish (cleaning instructions)** 304
 - Maximum load rating** 344
 - Maximum permissible load**
 - Calculation example 340
 - Determining 339
 - Maximum speeds** 369
 - Maximum tire pressure** 344
 - Mechanical key**
 - Inserting/removing 56

- Media**
 - Menu (on-board computer) 180
 - Searching 280
- Media display**
 - Notes 198
- Media Interface**
 - Activating 281
 - Information 280
 - Overview 281
- Media mode**
 - Activating 275
- Media playback**
 - Operating (on-board computer) 180
- Media search**
 - Starting 280
- Media source**
 - Selecting (on-board computer) 180
- Memory function**
 - Operating 87
 - Outside mirrors – Calling up stored settings 87
 - Outside mirrors – Storing settings 87
 - Seat – Calling up stored settings 87
 - Seat – Storing settings 87
- Steering wheel – Calling up saved settings 87
- Steering wheel – Saving settings 87
- Menu (on-board computer)**
 - Assistance 174
 - Designs 172
 - Maintenance 173
 - Media 180
 - Navigation 179
 - Overview 170
 - Performance 174
 - Radio 180
 - Telephone 181
 - Trip 177
- Mercedes me calls**
 - Arranging a service appointment 263
 - Breakdown assistance call 262
 - Calling the Mercedes-Benz Customer Center 262
 - Making a call via the overhead control panel 261
 - MB Info call 262
 - Transferred data 263
- Mercedes me connect**
 - Accident and breakdown management 264
 - Information 264
 - Transferred data 264
- Mercedes-Benz Apps**
 - Calling up 269
 - Using voice control 269
- Mercedes-Benz emergency call system**
 - Automatic emergency call 266
 - Information 264
 - Information on data transfer 267
 - Manual emergency call 266
 - Overview 265
- Mercedes-Benz Link**
 - Connecting 257
 - Ending 257
 - Overview 256
 - Using 257
- Message (multifunction display)**
 - see Display message
- Message memory** 371

- Messages**
 Voice commands (Voice Control System) 194
- Messages**
 see Text messages
- Mirrors**
 see Exterior mirrors
- Mobile phone**
 see Android Auto
 see Apple CarPlay®
 see Mercedes-Benz Link
 see Second telephone
 see Telephone
- Mobile phone voice recognition**
 Starting 251
 Stopping 251
- Model series**
 see Vehicle identification plate
- MOExtended tires** 313
- Multifunction display**
 Overview of displays 173
- Multifunction steering wheel**
 Overview of buttons 170
- Multifunction steering wheel**
 see Steering wheel
- Multimedia system** 197
 Adjusts the volume 203
 Central control elements 198
 Configuring display settings 206
 Configuring drive program I 123
 Favorites 202
 Overview 197
 Restoring the factory settings 216
 Switching the sound on/off 203
- Multimedia system**
 see Entering characters
 see Touch Control
 see Touchpad
- N**
- Navigation**
 Calling up the Digital Operator's Manual 245
 Menu (on-board computer) 179
 Showing/hiding the menu 221
 Switching on 221
 Updating the map data 243
- Voice commands (Voice Control System) 187
- Navigation**
 see Destination
 see Destination entry
 see Map
 see Route
 see Route guidance
 see Traffic information
- Navigation announcements**
 Activating/deactivating 234
 Adjusting the volume 235
 Repeating 235
 Switching audio fadeout on/off 235
- Navigation messages**
 On-board computer 179
- Neutral**
 Engaging 124
- Notes on breaking-in a new vehicle** 111
- O**
- Occupant safety**
 Pets in the vehicle 52

- Occupant safety**
 see Airbag
 see Automatic front passenger front airbag shutoff
 see PRE-SAFE® (anticipatory occupant protection)
 see Restraint system
 see Seat belt
- Odometer**
 see Total distance
- Oil**
 see Engine oil
- On-board computer** 170
 Assistance menu 174
 Displaying the service due date 295
 Media menu 180
 Menu designs 172
 Menu overview 170
 Multifunction display 173
 Navigation system menu 179
 Operating 170
 Performance menu 174
 Radio menu 180
 Service menu 173
 Telephone menu 181
- Trip menu 177
- On-board diagnostics interface**
 see Diagnostics connection
- Online services**
 Data storage 28
- Open-source software** 29
- Opening the trunk lid using your foot**
 HANDS-FREE ACCESS 64
- Operating fluids**
 Additives (fuel) 364
 Brake fluid 365
 Coolant (engine) 366
 Engine oil 365
 Fuel (gasoline) 363
 Notes 362
 Refrigerant (air conditioning system) ... 367
 Windshield washer fluid 367
- Operating safety**
 Declaration of conformity (wireless vehicle components) 23
 Information 22
- Operating system**
 see On-board computer
- Operator's Manual**
 Vehicle equipment 20
- Operator's Manual (digital)** 18
- Overhead control panel**
 Overview 12
- P**
- Paint code** 360
- Paintwork (cleaning instructions)** 304
- Panic alarm** 55
 Activating/deactivating 55
- Park position**
 Engaging 125
 Selecting automatically 125
- Parking**
 see Electric parking brake
- Parking aid**
 see Parking Assist PARKTRONIC
- Parking Assist PARKTRONIC** 158
 Activating 160
 Adjusting warning tones 160
 Function 158
 Switching off 160

- System limitations 158
 - Parking brake**
 - see Electric parking brake
 - Parking for an extended period** 138
 - Parking lights** 95
 - Parking position**
 - Exterior mirrors 103
 - Storing the position of the front-passenger outside mirror using reverse gear 103
 - PASSENGER AIR BAG status display**
 - see Automatic front passenger front airbag shutoff
 - Payload**
 - Calculation example 340
 - Determining the maximum 339
 - Performance (on-board computer, Performance menu)** 174
 - Permitted towing methods** 324
 - Personalization**
 - see User profile
 - Pets in the vehicle** 52
 - Phone book**
 - see Contacts
 - Picture formats**
 - see Video mode
 - Picture settings**
 - see Video mode
 - PIN protection**
 - Activating/deactivating 212
 - Plastic trim (Care)** 310
 - Playback options**
 - Selecting 277
 - POI**
 - Selecting 224
 - POI symbols**
 - Selecting 241
 - Power output (on-board computer, Performance menu)** 174
 - Power supply**
 - Switching on (Start/Stop button) 109
 - Power washer (care)** 303
 - Power windows**
 - see Side windows
 - PRE-SAFE® (anticipatory occupant protection)** 45
 - Function 45
 - PRE-SAFE® Sound 45
 - Reversing measures 46
 - Preventative occupant protection system**
 - see PRE-SAFE® (anticipatory occupant protection)
 - Previous destinations**
 - Selecting 224
 - Protecting the environment**
 - Notes 19
 - Protection against theft**
 - see ATA (anti-theft alarm system)
- Q**
- QR code**
 - Rescue card 26
 - Qualified specialist workshop** 24

- R**
- RACE START**
- Activating 153
 - Activation conditions 153
 - Function 152
- RACETIMER (on-board computer, Performance menu) 176**
- Racetrack operation**
- Information 117
- Radar and ultrasonic sensors**
- Damage 138
- Radio**
- Activating/deactivating radio text 288
 - Calling up the station list 287
 - Deleting channels 287
 - Direct frequency entry 287
 - Displaying information 288
 - Displaying radio text 288
 - Editing station presets 287
 - Menu (on-board computer) 180
 - Moving stations 287
 - Overview 286
 - Searching for stations 287
 - Setting a channel 287
 - Setting the waveband 287
 - Storing radio stations 287
 - Switching on 285
 - Switching the HD radio function on/off 287
 - Voice commands (Voice Control System) 191
- Radio stations**
- Dialing (on-board computer) 180
- Range**
- Displaying 177
- Reading light**
- see Interior lighting
- Real wood (Care) 310**
- Rear axle steering 114**
- Rear fog lamp**
- Switching on/off 96
- Rear view camera 161**
- Care 307
 - Function 161
 - Switching automatic mode on/off 163
- Rear wing**
- Setting 120, 155
- Reflective safety vest 312**
- Refrigerant (air conditioning system)**
- Notes 367
- Refueling**
- Refueling the vehicle 127
- Reporting malfunctions relevant to safety 25**
- Rescue card 26**
- Reserve**
- Fuel 364
- Reset function (multimedia system) 216**
- Restoring (factory settings)**
- see Reset function (multimedia system)
- Restraint system 31**
- Basic instructions for children 46
 - Function in an accident 32
 - Functionality 32
 - Malfunction 32
 - Protection 31
 - Reduced protection 31
 - Self-test 32
 - Warning lamp 32

- Reverse gear**
Engaging 124
- Rims (Care)** 307
- Roadside Assistance** 21
- Rocking free** 125
- Roll away protection**
see HOLD function
- Route** 229, 231
Calculating 229
Displaying destination information 231
Planning 226
Selecting a type 229
Selecting an alternative route 231
Selecting notifications 230
Selecting options 230
Starting the automatic service station search 231
Switching the automatic gas station search on/off 231
Using automatic gas station search 231
With intermediate destinations 226
- Route guidance** 232
Canceling 235
Changing direction 233
- Destination reached 234
From an off-road location 236
Lane recommendations 233
Notes 232
Off-road 236
To an off-road destination 235
- Run-flat characteristics**
MOExtended tires 313
- S**
- Safety systems**
see Driving safety system
- Satellite map** 245
- Satellite radio**
Activating/deactivating TuneStart 291
Adding a channel to Smart Favorites ... 291
Deleting a channel 290
Displaying EPG information 290
Displaying service information 291
Information 288
Information about Smart Favorites and TuneStart 291
Logging in 288
Moving a channel 290
- Music and sport alerts function 290
Overview 289
Pause and playback function 291
Restrictions 288
Selecting a category 289
Selecting a channel 290
Setting music and sport alerts 290
Setting the parental control 290
Storing a channel 290
Switching on 288
- SD card**
Inserting/removing 275
- Seat** 77
4-way lumbar support 80
Adjusting (electrically) 79
Correct driver's seat position 77
Operating the memory function 87
Setting 77
Setting options 14
Switching AIRSCARF on/off 83
- Seat belt** 33
Care 310
Fastening 36
Protection 33

- Seat belt adjustment**
 - Activating/deactivating 37
 - Function 37
- Seat belt warning**
 - see Seat belts
- Seat belts** 37
 - Activating/deactivating seat belt adjustment 37
 - Reduced protection 34
 - Releasing 37
 - Seat belt adjustment (function) 37
 - Warning lamp 37
- Seat cover (Care)** 310
- Seat heating**
 - Activating/deactivating 82
- Seat ventilation**
 - Switching on/off 83
- Second telephone** 249
 - Connecting 249
 - Features 249
- Selecting a gear**
 - see Changing gears
- Selecting the sound profile**
 - Burmester® high-end Surround sound system 294
- Selector lever**
 - see E-SELECT selector lever
- Self-test**
 - Automatic front passenger front air-bag shutoff 43
- Sensors (Care)** 307
- Service center**
 - see Qualified specialist workshop
- Service interval display**
 - see ASSYST PLUS
- Service station search**
 - Starting automatic search 231
- Setting a speed**
 - see Cruise control
- Setting summer time** 207
- Setting the date format** 207
- Setting the distance unit** 211
- Setting the map scale**
 - see Map
- SETUP (on-board computer, Performance menu)** 174
- Shift paddles**
 - see Steering wheel paddle shifters
- Shifting gears**
 - Gearshift recommendation 126
- Short messages**
 - see Text messages
- Side airbag** 38
- Side windows** 71
 - Closing 71
 - Closing using the SmartKey 73
 - Convenience closing feature 73
 - Convenience opening 72
 - Opening 71
 - Opening with the SmartKey 72
 - Problem 73
- Size designation (tires)** 345
- SmartKey** 54
 - Acoustic locking verification signal 55
 - Battery 56
 - Energy consumption 55
 - Features 54

- Key ring attachment 56
- Mechanical key 56
- Overview 54
- Panic alarm 55
- Problem 58
- Starting the vehicle 111
- Unlocking setting 55
- SmartKey functions**
 - Deactivating 55
- Smartphone**
 - see Android Auto
 - see Apple CarPlay®
 - see Mercedes-Benz Link
 - see Telephone
- Snow chains** 331
- Socket (12 V)**
 - Armrest 92
 - Trunk 93
- Soft top**
 - Care 307
 - Closing (soft-top switch) 66
 - Closing using the SmartKey 73
 - Opening (soft-top switch) 66
 - Opening with the SmartKey 72
- Problem 70
- Relocking 68
- Soft-top switch** 66
- Software update** 214
 - Important system updates 215
 - Information 214
 - Performing 215
- Sound**
 - PRE-SAFE® Sound 45
 - Wheels and tires 330
- Sound**
 - see Burmester® surround sound system
 - see Sound settings
- Sound settings** 292
 - Adjusting the balance 292
 - Adjusting treble, mid-range and bass settings 292
 - Automatic volume adjustment 292
 - Calls up the sound menu 292
 - Information 292
- Special seat belt retractor** 50
- Specialist workshop** 24
- Speech dialog system**
 - see Voice Control System
- Speed index (tires)** 345
- Speedometer**
 - Digital 177
- Sports exhaust**
 - see AMG Performance adjustable exhaust system
- Standard**
 - see Lane Keeping Assist
- Standing lights** 95
- Start/Stop button**
 - Emotion Start 110
 - Parking the vehicle 130
 - Starting the vehicle 110
 - Switching on the power supply or ignition 109
- Start/stop function**
 - see ECO start/stop function
- Starting**
 - see Vehicle
- Starting assistance**
 - see Jump-start connection

- Starting-off aid**
see Hill start assist
- Station**
Deleting 287
Direct frequency entry 287
Moving 287
Searching 287
Setting 287
Storing 287
- Station list**
Calling up 287
- Station presets**
Editing 287
Modifying 287
- Steering wheel** 170
Adjusting (electrically) 85
Adjusting (manually) 84
Buttons 170
Operating the memory function 87
- Steering wheel paddle shifters** 126
- Stowage areas**
see Stowage compartment
- Stowage compartment** 89
Armrest 89
Center console 89
Door 89
Glove box 89
- Stowage compartments**
see Stowage compartment
- Sulfur content** 363
- Sun visor**
Operating 104
- Surround lighting** 99
Setting 99
- Suspension**
AMG adaptive sport suspension system 157
Components 120
Measurements 120
Selecting the suspension setting 157
Settings 120
- Switch-off delay time**
Exterior 99
Interior 99
- Switching the surround sound on/off**
Burmester® surround sound system ... 293
- Synchronization function**
Switching on/off (control panel) 106
- System settings**
Activating/deactivating PIN protection 212
Reset function (multimedia system) 216
Setting the distance unit 211
Setting the time and date automatically 206
Setting the time zone 207
Setting the time/date format 207
- System settings**
see Bluetooth®
see Data import/export
see Language
see Software update
see Wi-Fi
- T**
- Tailpipes (Care)** 307
- Tank content**
Fuel 364

- Reserve (fuel) 364
- Technical data**
- Information 360
- Vehicle identification plate 360
- Telemetry display**
- Calling up 219
- Telephone** 181, 247
- Activating functions during a call 251
- Call and ringtone volume 251
- Calls with several participants 251
- Connecting a mobile phone (Pass-key) 248
- Connecting a mobile phone (Secure Simple Pairing) 248
- De-authorizing a mobile phone 250
- Disconnecting a mobile phone 250
- Importing contacts 253
- Importing contacts (overview) 253
- Incoming call during an existing call 252
- Information 248
- Interchanging mobile phones 249
- Menu (on-board computer) 181
- Mobile phone voice recognition 251
- Notes 245
- Operating modes 248
- Reception and transmission volume 251
- Telephone menu overview 247
- Telephone operation 251
- Voice commands (Voice Control System) 191
- Telephone number**
- Dialing (on-board computer) 181
- Telephony operating modes**
- Bluetooth® Telephony 248
- Telephony operating modes**
- see Second telephone
- Temperature**
- Engine oil (on-board computer, Performance menu) 174
- Transmission oil (on-board computer, Performance menu) 174
- Temperature grade** 342
- Text messages** 255
- Calling a message sender 256
- Changing folders 256
- Composing 255
- Configuring the displayed text messages 255
- Deleting 256
- Drafts 256
- Notes 255
- Options 256
- Outbox 256
- Read-aloud function 255
- Reading 255
- Replying 256
- Sending 255
- Voice commands (Voice Control System) 194
- Time**
- Manual time setting 207
- Setting summer time 207
- Setting the time and date automatically 206
- Setting the time zone 207
- Setting the time/date format 207
- TIN (Tire Identification Number)** 343
- Tire and Loading Information placard** ... 338
- Tire characteristics** 345
- Tire inflation compressor**
- see TIREFIT kit
- Tire information table** 338























- Tire labeling** 342
 - Characteristics 345
 - DOT, Tire Identification Number (TIN) 343
 - Load index 345
 - Load-bearing capacity 345
 - Maximum tire load 344
 - Maximum tire pressure 344
 - Overview 342
 - Speed rating 345
 - Temperature grade 342
 - Tire Quality Grading 342
 - Tire size designation 345
 - Traction grade 342
 - Tread wear grade 342
- Tire load (maximum)** 344
- Tire pressure** 333, 334
 - Checking (manually) 334
 - Checking (tire pressure monitoring system) 336
 - Maximum 344
 - Notes 331
 - Restarting the tire pressure monitoring system 337
 - Tire pressure monitoring system (function) 335
 - Tire pressure table 333
 - TIREFIT kit 314
- Tire pressure monitor** 337
 - Restarting 337
- Tire pressure monitoring system**
 - Checking the tire pressure 336
 - Function 335
- Tire pressure table** 333
- Tire Quality Grading** 342
- Tire temperature**
 - Tire pressure monitoring system (function) 335
- Tire tread** 330
- Tire-change tool kit**
 - Overview 353
- TIREFIT kit** 314
 - Storage location 314
 - Using 314
- Tires**
 - Characteristics 345
 - Checking 330
 - Checking the tire pressure (manually) 334
 - Checking the tire pressure (tire pressure monitoring system) 336
 - Definitions 347
 - DOT, Tire Identification Number (TIN) 343
 - Flat tire 312
 - Installing 358
 - Load index 345
 - Load-bearing capacity 345
 - Maximum tire load 344
 - Maximum tire pressure 344
 - MOExtended tires 313
 - Noise 330
 - Notes 119
 - Notes on installing 350
 - Overview of tire labeling 342
 - Removing 357
 - Replacing 350, 354
 - Restarting the tire pressure monitoring system 337
 - Rotating 352
 - Selection 350
 - Snow chains 331
 - Speed rating 345

- Storing 353
- Temperature grade 342
- Tire and Loading Information placard
..... 338
- Tire pressure (notes) 331
- Tire pressure monitoring system
(function) 335
- Tire pressure table 333
- Tire Quality Grading 342
- Tire size designation 345
- TIREFIT kit 314
- Traction grade 342
- Tread wear grade 342
- Unusual handling characteristics 330
- Tool**
see Vehicle tool kit
- Torque (on-board computer, Performance menu)** 174
- Total distance** 177
Displaying 177
- Touch Control** 199
On-board computer 170
Operating 199
Setting the sensitivity 199
- Touchpad** 200
Activating/deactivating haptic operation feedback 201
Operating 200
Reading the handwriting recognition
aloud 201
Selecting a station and track 201
Setting the sensitivity 201
- Tow-bar system** 168
- Tow-starting** 327
- Towing away** 325
- Towing eye**
Installing 327
Storage location 327
- Towing methods** 324
- Track**
Selecting (audio mode) 277
- Track Race**
Setting 217
- Traction control**
Function/notes 154
Setting 154
- Traction grade** 342
- Traffic information** 237
Displaying the traffic map 238
Displaying traffic incidents 239
Extending a Live Traffic Information
subscription 238
Issuing hazard warnings 240
Live Traffic Information 238
Overview 237
- Traffic map**
see Map
- Traffic Sign Assist** 164
Function/notes 164
Setting 166
System limitations 164
- Transferred vehicle data**
Android Auto 261
Apple CarPlay® 261
- Transmission position display** 123
- Transporting**
Vehicle 326
- Tread wear grade** 342
- Trim element (Care)** 310

- Trip**
 Menu (on-board computer) 177
- Trip computer**
 Displaying 177
 Resetting 178
- Trip distance** 177
 Displaying 177
 Resetting 178
- Trip odometer**
 see Trip distance
- Trunk lid**
 Closing 64
 Emergency release (from inside) 66
 HANDS-FREE ACCESS 64
 Locking separately 65
 Opening 63
 Opening dimensions 368
- Turn signal indicator**
 see Turn signals
- Turn signals** 96
 Switching on/off 96
- U**
- Units of measurement**
 Setting 211
- Unlocking setting** 55
- USB devices**
 Connecting 276
- User profile** 213
 Creating 213
 Importing/exporting 213
 Options 214
 Setting 213
- Using the telephone**
 see Calls
- V**
- Vehicle** 111
 Correct use 25
 Data acquisition 26
 Data storage 26
 Diagnostics connection 23
 Equipment 20
 Limited Warranty 26
 Load on assemblies 117
- Locking (automatically) 61
 Locking (from the inside) 59
 Locking (KEYLESS-GO) 59
 Locking/unlocking (emergency key) 62
 Lowering 359
 Maintenance 21
 Parking for an extended period 138
 Problem notification 25
 QR code rescue card 26
 Qualified specialist workshop 24
 Raising 355
 Rocking free 125
 Starting (Emotion Start) 110
 Starting (SmartKey) 111
 Starting (start/stop button) 110
 Switching off (start/stop button) 130
 Towing 168
 Unlocking (from the inside) 59
 Unlocking (KEYLESS-GO) 59
 Ventilating (convenience opening) 72
 Voice commands (Voice Control System) 195
- Vehicle data**
 Displaying (DYNAMIC SELECT) 123
 Maximum speeds 369

- Transferring to Android Auto 261
- Transferring to Apple CarPlay® 261
- Turning radius 368
- Vehicle height 368
- Vehicle length 368
- Vehicle width 368
- Weights 369
- Wheelbase 368
- Vehicle data storage**
 - Event data recorders 28
 - Multimedia system/Mercedes me connect 28
- Vehicle dimensions** 368
- Vehicle identification number**
 - see VIN
- Vehicle identification plate** 360
 - Paint code 360
 - VIN 360
- Vehicle key**
 - see SmartKey
- Vehicle maintenance**
 - see ASSYST PLUS
- Vehicle operation**
 - Outside the USA or Canada 21
- Vehicle tool kit** 314
 - TIREFIT kit 314
 - Towing eye 327
- Ventilating**
 - Convenience opening 72
- Vents**
 - see Air vents
- Video mode** 280
 - Activating 277
 - Activating/deactivating full-screen mode 279
 - Overview 279
 - Settings 280
- VIN** 360
 - Identification plate 360
 - Seat 360
 - Windshield 360
- Vision**
 - Removing condensation from the windows 106
- Voice command types (Voice Control System)** 185
- Voice Control System** 184
 - Application specific voice commands 185
 - Audible help functions 185
 - Global voice commands 185
 - Improving speech quality 185
 - Language setting 185
 - Media player voice commands 193
 - Message voice commands 194
 - Multifunction steering wheel (operating) 184
 - Navigation voice commands 187
 - Operable functions 185
 - Operating safety 183
 - Radio voice commands 191
 - Switch voice commands 186
 - Telephone voice controls 191
 - Text message voice commands 194
 - Types of voice commands 185
 - Vehicle voice commands 195
 - Voice prompting 184
- Voice control system**
 - see Voice Control System

W

- Warm-up (on-board computer, Performance menu)** 174
- Warning lamps**
see Warning/indicator lamps
- Warning system**
see ATA (anti-theft alarm system)
- Warning/indicator lamp**
-  ABS warning lamp 417
 -  Brake warning lamp (USA) 420
 -  Brakes warning lamp (Canada) 420
 -  Coolant warning lamp 427
 -  Electrical malfunction warning lamp 426
 -  Engine diagnosis warning lamp ... 426
 -  ESP[®] OFF warning lamp 419
 -  ESP[®] SPORT warning lamp 419
 -  ESP[®] warning lamp flashes 418
 -  ESP[®] warning lamp lights up 418
 -  Fuel reserve warning lamp .. 426, 427
 -  Red indicator lamp, electric parking brake applied (Canada only) ... 422
 -  Red indicator lamp, electric parking brake applied (USA only) 422
 -  Restraint system warning lamp ... 423
 -  Seat belt warning lamp flashes ... 424
 -  Seat belt warning lamp lights up 424
 -  Suspension warning lamp 425
 -  Tire pressure monitoring system warning lamp flashes 430
 -  Tire pressure monitoring system warning lamp lights up 429
 -  Warning lamp for distance warning function 425
 -  Warning lamp for electric power steering 430
 -  Yellow electric parking brake indicator lamp is malfunctioning 422
- Warning/indicator lamps** 416
- Overview 416
 - PASSENGER AIR BAG 43
- Warranty** 26
- Washer fluid**
see Windshield washer fluid
- Washing by hand (care)** 303
- Water tank**
see Air-water duct
- Wear**
- Brake discs 118
 - Brake pads 118
 - Wheel bolts 119
- Weather information** 245
- Web browser**
- Calling up a web page 270
 - Calling up options 271
 - Calling up the settings 271
 - Deleting a bookmark 271
 - Deleting browser data 271
 - Ending 271
 - Managing bookmarks 271
 - Overview 270

- Showing/hiding the menu 270
- Website**
- Calling up 270
- Showing/hiding the web browser menu 270
- Wheel change**
- Lowering the vehicle 359
- Mounting a new wheel 358
- Removing a wheel 357
- Wheel rotation** 352
- Wheels**
- Care 307
- Checking 330
- Checking the tire pressure (manually) 334
- Checking the tire pressure (tire pressure monitoring system) 336
- Definitions 347
- DOT, Tire Identification Number (TIN) 343
- Flat tire 312
- Installing 358
- Load index 345
- Load-bearing capacity 345
- Maximum tire load 344
- Maximum tire pressure 344
- MOExtended tires 313
- Noise 330
- Notes 119
- Notes on installing 350
- Overview of tire labeling 342
- Removing 357
- Replacing 350, 354
- Restarting the tire pressure monitoring system 337
- Rotating 352
- Selection 350
- Snow chains 331
- Speed rating 345
- Storing 353
- Temperature grade 342
- Tire and Loading Information placard 338
- Tire characteristics 345
- Tire pressure (notes) 331
- Tire pressure monitoring system (function) 335
- Tire pressure table 333
- Tire Quality Grading 342
- Tire size designation 345
- TIREFIT kit 314
- Traction grade 342
- Tread wear grade 342
- Unusual handling characteristics 330
- Wi-Fi** 208
- Overview 208
- Setting 208
- Setting up a hotspot 209
- Wind screen**
- Installing 68
- removal 68
- Windows**
- see Side windows
- Windows (Care)** 307
- Windshield** 100
- Replacing the wiper blades 100
- Windshield**
- see Windshield
- Windshield washer fluid** 367
- Notes 367
- Windshield washer system**
- Topping up 301

Windshield wipers

- Activating/deactivating 100
- Replacing the wiper blades 100

Winter operation

- Snow chains 331

Wiper blades

- Care 307
- Replacing 100

Wireless vehicle components

- Declaration of conformity 23

Workshop

- see Qualified specialist workshop



