



Digital – in the vehicle

Familiarize yourself with the contents of the Operator's Manual directly via the vehicle's multimedia system (menu item "Vehicle"). Start with the quick guide, discover your vehicle's highlights or broaden your knowledge with useful tips.



Vehicle document wallet

Here you can find comprehensive information about operating your vehicle and about services and warranties in printed form.



Digital – on the Internet

You can find the Operator's Manual on the Mercedes-Benz homepage.



Digital – as an App

The Mercedes-Benz Guides App is available free-of-charge in familiar App stores.

G-Class



Order no. P463 0239 13 Part no. 463 584 49 06
Edition C2 2019



Apple® iOS



Android™

Mercedes-Benz

G-Class Operator's Manual

Mercedes-Benz



Front passenger airbag warning

Observe the chapter "Children in the vehicle".

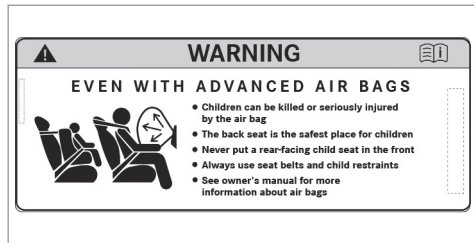

Example

⚠ WARNING Risk of injury or fatal injuries if the front-passenger airbag is enabled

If the front-passenger front airbag is enabled, a child on the front-passenger seat may be struck by the front-passenger airbag during an accident.

NEVER use a rearward-facing child restraint system on a seat with an ENABLED FRONT AIRBAG, DEATH or SERIOUS INJURY to the CHILD can occur.

Publication details

Internet

Further information about Mercedes-Benz vehicles and about Daimler AG can be found on the following websites:

<http://www.mbusa.com> (USA only)

<http://www.mercedes-benz.ca> (Canada only)

Documentation team

©Daimler AG: not to be reprinted, translated or otherwise reproduced, in whole or in part, without written permission from Daimler AG.

Vehicle manufacturer

Daimler AG

Mercedesstrasse 137

70327 Stuttgart

Germany

Welcome to the world of Mercedes-Benz

Before you first drive off, read this Operator's Manual carefully and familiarize yourself with your vehicle. For your own safety and a longer operating lifespan, follow the instructions and warning notices in this Operator's Manual. Disregarding them may lead to damage to the vehicle or personal injury.

Vehicle damage resulting from the disregard of the instructions is not covered by the Mercedes-Benz Limited Warranty.

The equipment or model designation of your vehicle may vary according to:

- Model
- Order
- National version
- Availability

Mercedes-Benz reserves the right to introduce changes in the following areas:

- design
- equipment
- technical features

The equipment in your vehicle may therefore differ from that shown in the descriptions and illustrations.

The following are integral parts of the vehicle:

- Digital Operator's Manual
- Printed Operator's Manual
- Maintenance Booklet
- Equipment-dependent Supplements

Keep these documents in the vehicle at all times. If you sell the vehicle, always pass all of the documents on to the new owner.

Mercedes-Benz USA, LLC

Mercedes-Benz Canada, Inc.

A Daimler Company

4635844906



Symbols	5	Problems with your vehicle	25	Seats and stowing	79
At a glance	6	Reporting safety defects	25	Notes on the correct driver's seat position	79
Cockpit	6	Limited Warranty	25	Seats	80
Warning and indicator lamps	8	QR code for rescue card	26	Steering wheel	87
Overhead control panel	12	Data storage	26	Easy entry and exit feature	88
Door control panel and seat adjustment	14	Copyright	29	Operating the memory function	89
Emergencies and breakdowns	16			Stowage areas	90
		Occupant safety	31	Cup holder	101
Digital Operator's Manual	18	Restraint system	31	Ashtray and cigarette lighter	102
Calling up the Digital Operator's Manual	18	Seat belts	33	Sockets	104
		Airbags	38	Wireless charging of the mobile phone and connection with the exterior antenna ..	106
General notes	19	PRE-SAFE® system	45	Installing/removing the floor mats	108
Protecting the environment	19	Safely transporting children in the vehicle	46		
Genuine Mercedes-Benz parts	19	Notes on pets in the vehicle	61	Light and visibility	109
Operator's Manual	20			Exterior lighting	109
Service and vehicle operation	21	Opening and closing	62	Interior lighting	113
Operating safety	22	SmartKey	62	Windshield wiper and windshield washer system	115
Declaration of conformity for wireless vehicle components	23	Doors	67	Mirrors	118
Diagnostics connection	23	Rear-end door	68	Operating the sun visor	121
Qualified specialist workshop	24	Side windows	69	Area permeable to radio waves on the windshield	121
Correct use of the vehicle	24	Sliding sunroof	73		
		Anti-theft protection	76		

Climate control	122
Overview of climate control systems	122
Operating the climate control system	123

Driving and parking	126
Driving	126
DYNAMIC SELECT switch	135
G-Mode	137
Automatic transmission	138
Transfer case	143
Differential locks	145
Function of the 4MATIC	146
Refueling	147
Parking	149
Driving and driving safety systems	158
Trailer hitch	198
Vehicle towing instructions	200

Instrument Display and on-board computer	201
Instrument Display overview	201
Overview of the buttons on the steering wheel	202
Operating the on-board computer	202

Setting the design	204
Setting the additional value range	204
Overview of displays on the multifunction display	205
Adjusting the instrument lighting	206
Menus and submenus	206

Voice Control System	213
Notes on operating safety	213
Operation	213
Using the Voice Control System effectively	215
Essential voice commands	215

Multimedia system	227
Overview and operation	227
System settings	236
Navigation	247
Telephone	272
Online and Internet functions	294
Media	300
Radio	313
Sound	321
Rear Seat Entertainment System	322

Maintenance and care	336
ASSYST PLUS service interval display	336
Engine compartment	337
Cleaning and care	343

Breakdown assistance	353
Emergency	353
Flat tire	355
Battery (vehicle)	357
Tow starting or towing away	362
Electrical fuses	367

Wheels and tires	370
Notes on noise or unusual handling characteristics	370
Notes on regularly inspecting wheels and tires	370
Notes on snow chains	371
Tire pressure	371
Loading the vehicle	377
Tire labeling	381
Definition of terms for tires and loading	386
Changing a wheel	389
Emergency spare wheel	397

Technical data	399
Notes on technical data	399
Vehicle electronics	399
Vehicle identification plate, VIN and engine number	401
Operating fluids	402
Vehicle data	409
Trailer hitch	411

Display messages and warning/indicator lamps	413
Display messages	413
Warning and indicator lamps	458

Index	473
--------------------	------------

In this Operator's Manual, you will find the following symbols:

⚠ DANGER Danger due to not observing the warning notices

Warning notices draw your attention to hazards that may endanger your health or life, or the health or life of others.

▶ Observe the warning notices.

🌿 ENVIRONMENTAL NOTE Environmental damage due to failure to observe environmental notes

Environmental notes include information on environmentally responsible behavior or environmentally responsible disposal.

▶ Observe environmental notes.

! NOTE Damage to property due to failure to observe notes on material damage

Notes on material damage inform you of risks which may lead to your vehicle being damaged.

▶ Observe notes on material damage.

i Useful instructions or further information that could be helpful to you.

▶ Instruction

(→ page) Further information on a topic

Display Information on the multifunction display/media display



Highest menu level, which is to be selected in the multimedia system



Corresponding submenus, which are to be selected in the multimedia system

*



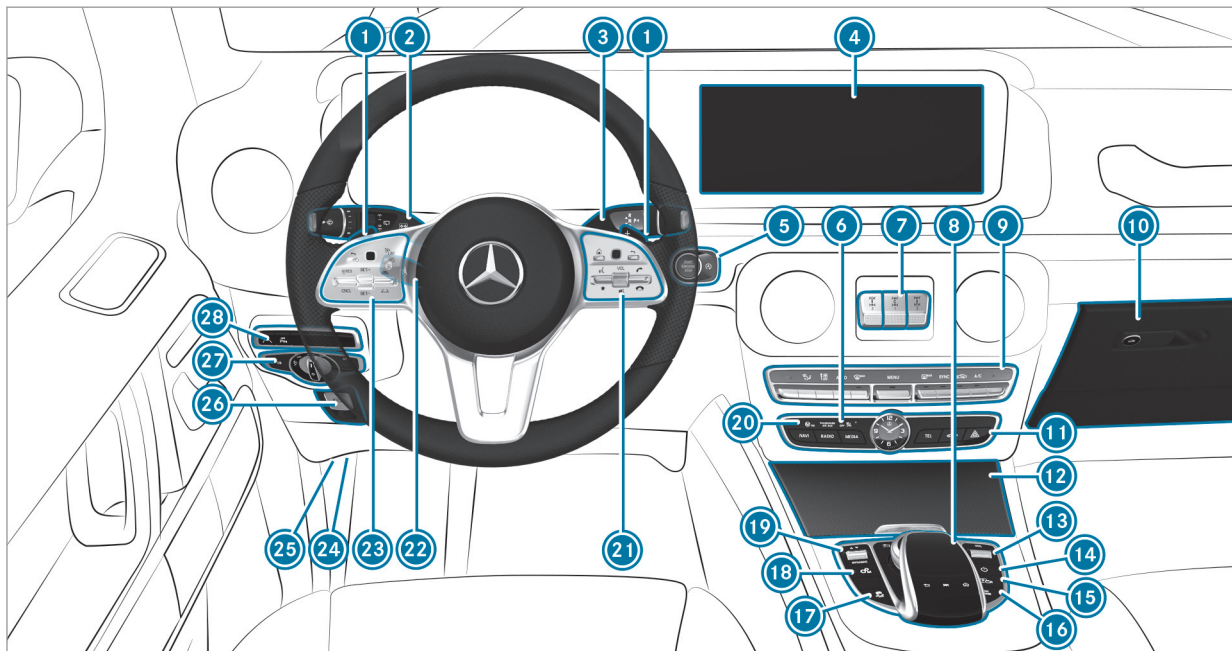



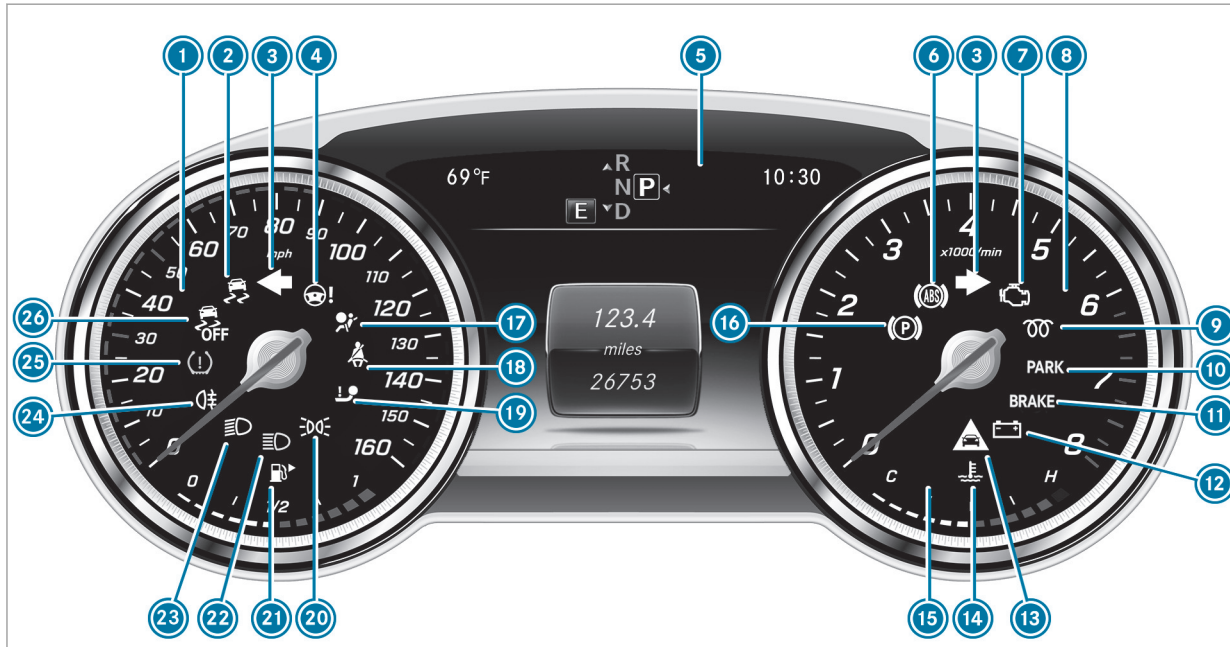

















Marks a cause



①	Steering wheel paddle shifters	→	140	①7	Activates/deactivates ESP®		
②	Combination switch	→	110	①8	Manual gearshifting	→	140
③	DIRECT SELECT lever	→	138	①9	DYNAMIC SELECT switch	→	136
④	Multimedia system display	→	228	②0	Control panel for the multimedia system	→	228
⑤	Start/stop button	→	127	②1	Control panel for the multimedia system (steering wheel)	→	202
⑥	PASSENGER AIR BAG indicator lamp	→	43	②2	Adjusts the steering wheel	→	87
⑦	Applies differential lock	→	145	②3	Control panel for the on-board computer	→	202
⑧	Control elements for the multimedia system	→	228		Operates cruise control	→	166
⑨	Climate control systems	→	123		Operates Active Distance Assist DISTRONIC	→	169
⑩	Glove box	→	93	②4	Diagnostics connection	→	23
⑪	Hazard warning lamps	→	111	②5	Opens the hood	→	337
⑫	Stowage compartment	→	92	②6	Electric parking brake	→	155
⑬	Control knob for volume and switching sound on/off	→	227	②7	Light switch	→	109
⑭	Switches the multimedia system on/off	→	227	②8	Control panel for:		
⑮	Active Parking Assist	→	185		Active Lane Keeping Assist	→	197
⑯	LOW RANGE off-road gear	→	143		PARKTRONIC	→	176







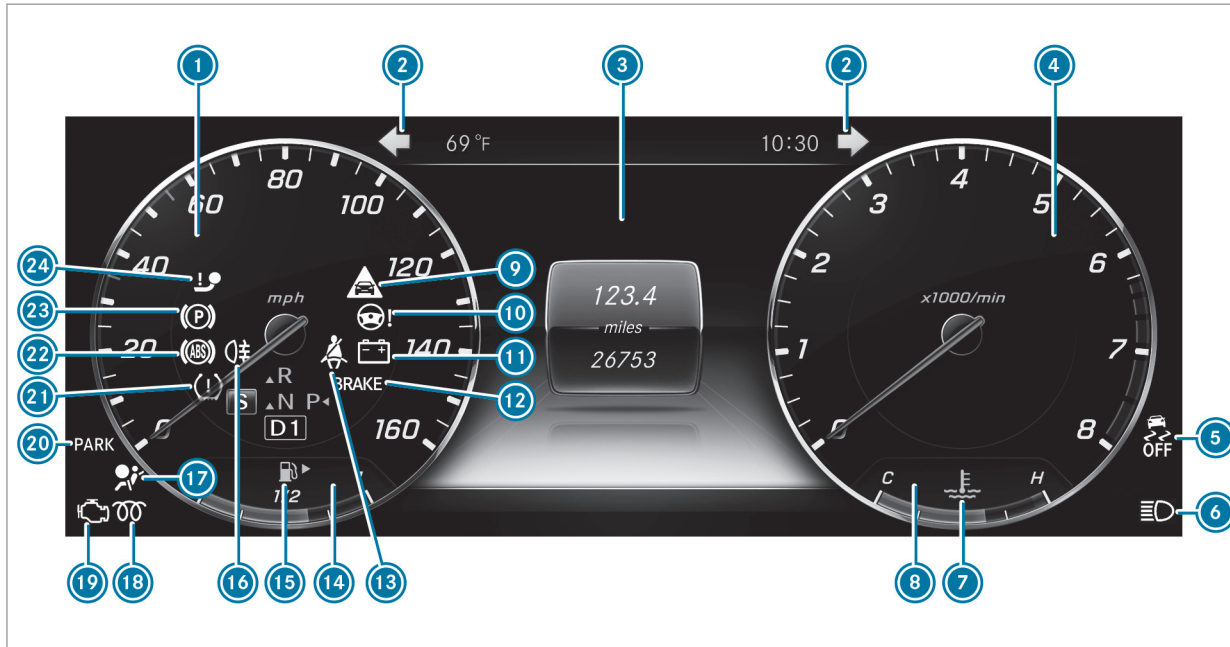





















Instrument Display (standard)







①	Speedometer	→	201	⑬	 Distance warning	→	466
②	 ESP®	→	460	⑭	 Coolant too hot/cold	→	467
③	  Turn signal lights	→	110	⑮	Coolant temperature gauge	→	201
④	 Power-assisted steering malfunction	→	471	⑯	 Electric parking brake (yellow)	→	460
⑤	Multifunction display	→	205	⑰	 Restraint system	→	32
⑥	 ABS malfunction	→	460	⑱	 Seat belt not fastened	→	465
⑦	 Check Engine	→	467	⑲	 Trailer hitch not operational	→	471
⑧	Tachometer	→	201	⑳	 Parking lights	→	109
⑨	 This indicator lamp has no function			㉑	Fuel level display		
⑩	Electric parking brake applied (red)	→	460		 Fuel reserve with fuel filler flap location indicator	→	467
	 USA only			㉒	 High beam	→	110
	 Canada only			㉓	 Low beam	→	109
⑪	Brakes (red)	→	460	㉔	 Rear fog light	→	110
	 USA only			㉕	 Tire pressure monitoring system	→	469
	 Canada only			㉖	 ESP® OFF	→	460
⑫	 Electrical malfunction	→	467				

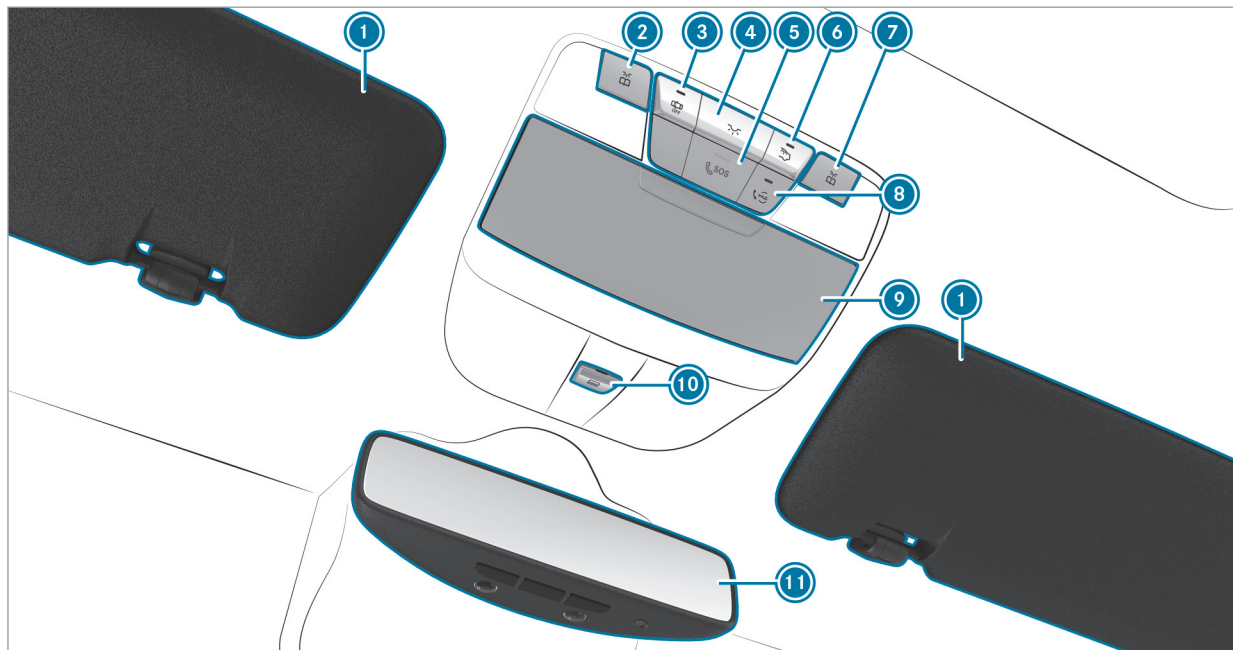

Instrument Display in the Widescreen Cockpit







①	 Speedometer	→	201		
②	  Turn signal light	→	110		
③	Multifunction display	→	205		
④	Tachometer	→	201		
⑤	 ESP® OFF	→	460		
	 ESP®	→	460		
⑥	 High beam	→	110		
	 Low beam	→	109		
	 Parking lights	→	109		
⑦	 Coolant too hot/cold	→	467		
⑧	Coolant temperature gauge	→	201		
⑨	 Distance warning	→	466		
⑩	 Power-assisted steering malfunction	→	471		
⑪	 Electrical malfunction	→	467		
⑫	Brakes (red)	→	460		
	 USA only				
	 Canada only				
⑬	 Seat belt not fastened	→	465		
⑭	Fuel level display				
⑮	 Fuel reserve with fuel filler flap location indicator	→	467		
⑯	 Rear fog light	→	110		
⑰	 Restraint system	→	32		
⑱	 This indicator lamp has no function				
⑲	 Check Engine	→	467		
⑳	Electric parking brake applied (red)	→	460		
	 USA only				
	 Canada only				
㉑	 Tire pressure monitoring system	→	469		
㉒	 ABS malfunction	→	460		
㉓	 Electric parking brake (yellow)	→	460		
㉔	 Trailer hitch not operational	→	471		

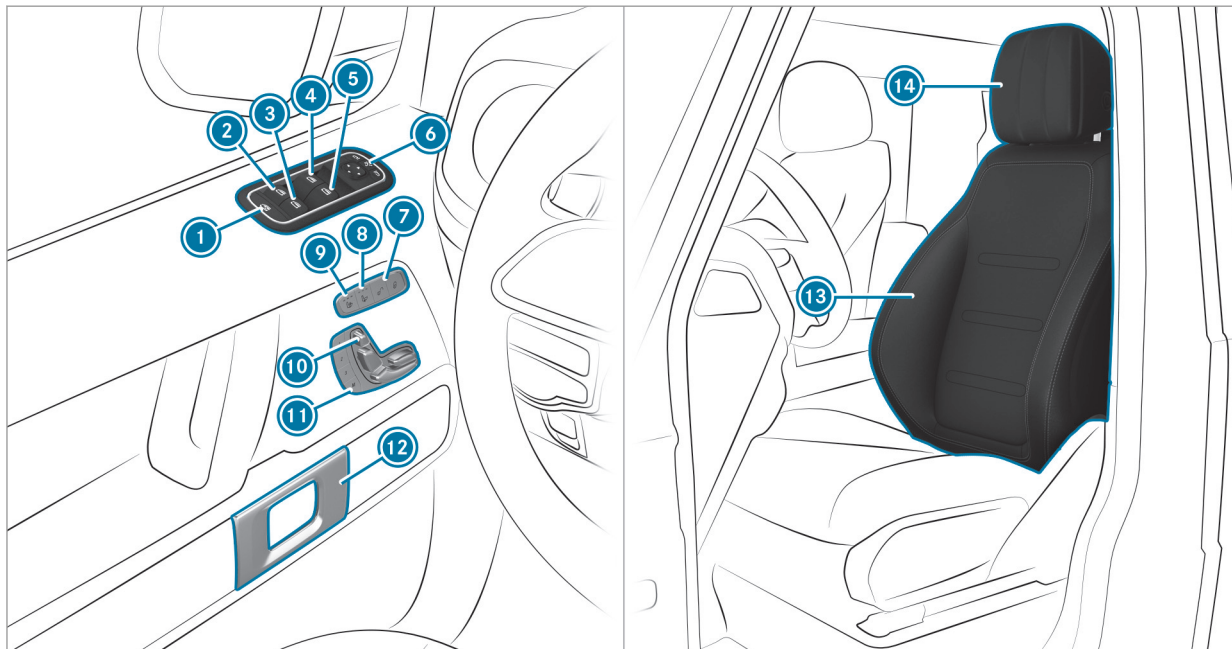

① Sun visors	→	121	⑥  Switches the rear interior lighting on/off	→	113
②  Switches the left-hand reading lamp on/off	→	113	⑦  Switches the right-hand reading lamp on/off	→	113
③  Switches the automatic lighting control on/off	→	113	⑧ Service call button (Mercedes me connect)	→	290
④  Switches the front interior lighting on/off	→	113	⑨ Eyeglasses compartment	→	93
⑤ SOS emergency call system (Mercedes-Benz emergency call system)	→	290	⑩  Opens/closes the sliding sunroof	→	73
			⑪ Inside rearview mirror	→	119

14 At a glance – Door control panel and seat adjustment



①	Child safety lock for the rear side windows	→	60	⑧	Switches the seat ventilation on/off	→	86
②	 Opens/closes the rear left side window	→	69	⑨	Switches the seat heater on/off	→	85
③	 Opens/closes the rear right side window	→	69	⑩	Adjusts the seats electrically	→	80
④	 Opens/closes the left side window	→	69	⑪	Operates the memory function	→	89
⑤	 Opens/closes the right side window	→	69	⑫	Opens the door	→	67
⑥	Operates the outside mirrors	→	118	⑬	Seat adjustment using the multimedia system	→	84
⑦	  Locks/unlocks the vehicle	→	67	⑭	Adjusts the luxury head restraints	→	82

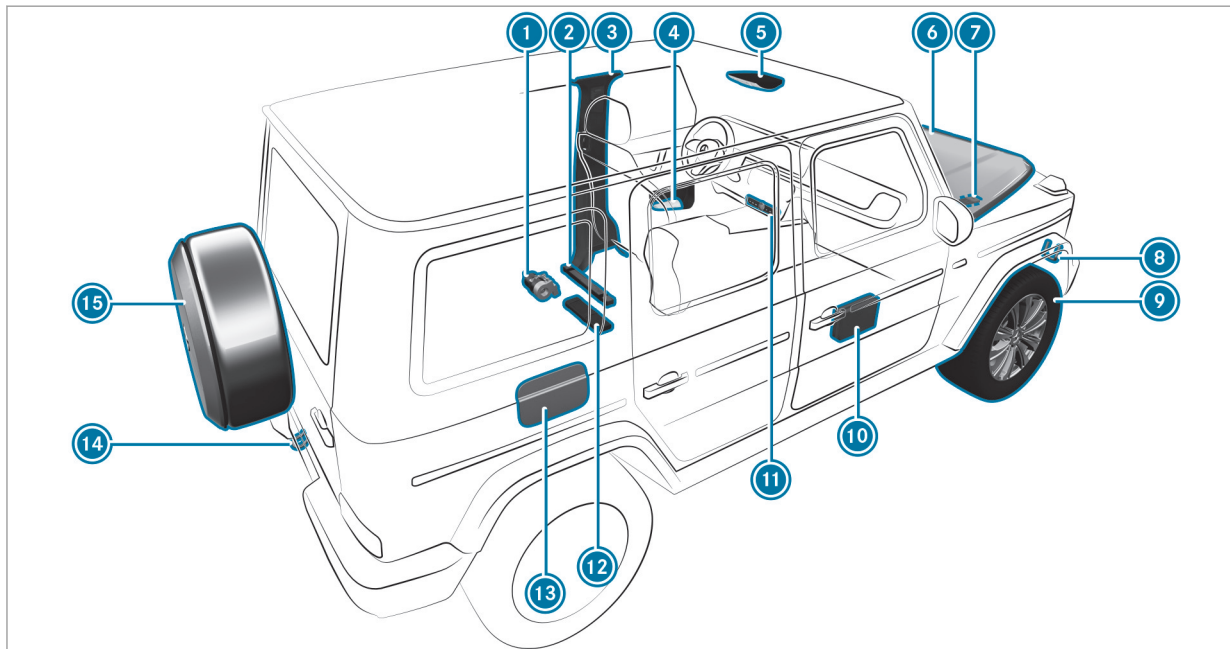

① Jack	→	392	⑩ First-aid kit (soft sided)	→	354
② Warning triangle	→	354	⑪ Hazard warning lamps	→	111
③ QR code for accessing the rescue card	→	26	⑫ Vehicle tool kit	→	392
④ Safety vests	→	353	⑬ Fuel filler flap with instruction labels for tire pressure, fuel type and QR code for accessing the rescue card	→	147
⑤ Mercedes-Benz emergency call system button	→	290	⑭ To tow-start and tow away	→	362
⑥ To check and top up operating fluids	→	402	⑮ Spare wheel	→	355
⑦ Starting assistance	→	360			
⑧ To tow-start and tow away	→	362			
⑨ Flat tire	→	355			

Calling up the Digital Operator's Manual

Multimedia system:

➔ Vehicle ➔ ⓘ Operator's Manual

▶ Select a menu item.

In addition, you can also call up the Operator's Manual within a main function (e.g. via [Media Info](#)).

The Digital Operator's Manual describes the function and operation of the vehicle and the multimedia system.

For safety reasons, the Digital Operator's Manual is deactivated while driving.



The Digital Operator's Manual contains the following menu items:

- **Search:** allows you to search precisely for keywords.
- **Quick start:** provides you with important information so that you can start using your vehicle immediately.
- **Tips:** provides tips on how to use your vehicle in certain situations.
- **Messages:** provides you with further information about the messages in the instrument cluster.
- **Bookmarks:** provides you with a list of all the bookmarks you have stored yourself.

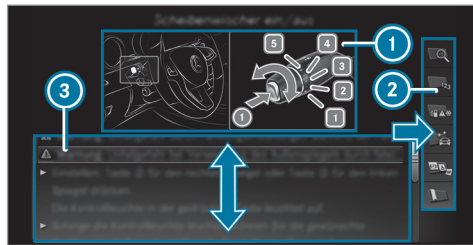

- ① Picture
- ② Menu
- ③ Navigation window

Some sections of the Digital Operator's Manual, such as warnings, can be made visible by highlighting and pressing them.

- ⓘ The Operator's Manual can also be found in the Mercedes-Benz Guides app in all common app stores.

Protecting the environment



ENVIRONMENTAL NOTE Environmental damage due to operating conditions and personal driving style

The pollutant emission of your vehicle is directly related to the way you operate your vehicle.

Help to protect the environment by operating your vehicle in an environmentally responsible manner. Please observe the following recommendations on operating conditions and personal driving style.

Operating conditions:

- ▶ Make sure that the tire pressure is correct.
- ▶ Do not carry any unnecessary weight (e.g. roof luggage racks once you no longer need them).
- ▶ Adhere to the service intervals. A regularly serviced vehicle will contribute to environmental protection.

- ▶ Always have maintenance work carried out at a qualified specialist workshop.

Personal driving style:

- ▶ Do not depress the accelerator pedal when starting the engine.
- ▶ Do not warm up the engine while the vehicle is stationary.
- ▶ Drive carefully and maintain a suitable distance from the vehicle in front.
- ▶ Avoid frequent, sudden acceleration and braking.
- ▶ Change gear in good time and use each gear only up to $\frac{2}{3}$ of its maximum engine speed.
- ▶ Switch off the engine in stationary traffic, e.g. by using the ECO start/stop function.
- ▶ Drive fuel-efficiently. Observe the ECO display for a fuel-efficient driving style.

Environmental issues and recommendations:

It is recommended that you re-use or recycle materials instead of just disposing of them.

The relevant environmental guidelines and regulations serve to protect the environment and must be strictly observed.

Genuine Mercedes-Benz parts



ENVIRONMENTAL NOTE Environmental damage caused by not using recycled/reconditioned components

Daimler AG offers recycled/reconditioned components and parts with the same quality as new parts. The same entitlement from the Limited Warranty is valid as for new parts.

- ▶ Use recycled/reconditioned components and parts from Daimler AG.

! **NOTE** Impairment of the operating efficiency of the restraint systems from installing accessory parts or from repairs or welding

Airbags and Emergency Tensioning Devices, as well as control units and sensors for the restraint systems, may be installed in the following areas of your vehicle:

- Doors
- Door pillars
- Door sills
- Seats
- Cockpit
- Instrument cluster
- Center console
- Lateral roof frame

- ▶ Do not install accessory parts such as audio systems in these areas.
- ▶ Do not carry out repairs or welding.

▶ Have aftermarket installation of accessories carried out at a qualified specialist workshop.

You could jeopardize the operating safety of your vehicle if you use parts, tires and wheels as well as accessories relevant to safety which have not been approved by Mercedes-Benz. Safety-relevant systems, e.g. the brake system, may malfunction. Only use Mercedes-Benz Genuine Parts or parts of equal quality. Only use tires, wheels and accessories that have been specifically approved for your vehicle model.

Mercedes-Benz Genuine Parts are subject to strict quality control. Each part has been specially developed, manufactured or selected for Mercedes-Benz vehicles and fine-tuned for them. Therefore, only Mercedes-Benz Genuine Parts should be used.

More than 300,000 different Mercedes-Benz Genuine Parts are available for Mercedes-Benz models.

All authorized Mercedes-Benz Centers maintain a supply of Mercedes-Benz Genuine Parts for

necessary service and repair work. In addition, strategically located parts delivery centers provide for quick and reliable parts service.

Always specify the vehicle identification number (VIN) (→ page 401) when ordering Mercedes-Benz Genuine Parts.

Operator's Manual

This Operator's Manual describes all models and all standard and optional equipment available for your vehicle at the time of this Operator's Manual going to press. Country-specific differences are possible. Note that your vehicle may not be equipped with all features described. This is also the case for systems and functions relevant to safety. Therefore, the equipment on your vehicle may differ from that in the descriptions and illustrations.

The original purchase agreement for your vehicle contains a list of all of the systems in your vehicle.

Should you have any questions concerning equipment and operation, please consult an authorized Mercedes-Benz Center.

The Operator's Manual and Maintenance Booklet are important documents and should be kept in the vehicle.

Service and vehicle operation

Vehicle operation outside the USA or Canada

When you are abroad with your vehicle, observe the following points:

- service points or replacement parts may not be available immediately.
- unleaded fuel may not be available for vehicles with a catalytic converter. Leaded fuel may cause damage to the catalytic converter.
- the fuel may have an extremely low octane number. Unsuitable fuel can cause engine damage.

Some Mercedes-Benz models are available in Europe through our European Delivery Program. For more information, please consult an authorized Mercedes-Benz service center, or write to one of the following address:

in the USA:

Mercedes-Benz USA, LLC
European Delivery Department
One Mercedes-Benz Drive
Sandy Springs, GA 30328

in Canada:

Mercedes-Benz Canada, Inc.
European Delivery Department
98 Vanderhoof Avenue
Toronto, Ontario M4G 4C9

Maintenance

Your customer advisor confirms the service in the service report.

Roadside Assistance

The Mercedes-Benz Roadside Assistance Program offers technical help in the case of a breakdown. Your calls to the toll-free Roadside Assistance Hotline are answered by our agents 24 hours a day, 365 days a year.

1-800-FOR-MERCEdes (1-800-367-6372) (USA)

1-800-387-0100 (Canada)

You can find further information in the Mercedes-Benz Roadside Assistance Program brochure (USA) or the "Roadside Assistance" section in the maintenance and warranty information booklet (Canada). You will find both in the vehicle document wallet.

Change of address or change of ownership

In the event of a change of address, please send us the "Notification of address change" in the Service and Guarantee booklet or simply call the Mercedes-Benz Customer Assistance Center (USA) on the hotline number 1-800-FOR-MERCEdes (1-800-367-6372) or Customer Service (Canada) on 1-800-387-0100. We can then reach you in a timely fashion, if necessary.

If you sell your Mercedes, please leave all literature in the vehicle so that it is available to the next owner. If you have purchased a used vehicle, please send us the "Notice of Purchase of Used Car" in the Service and Guarantee booklet or simply call the Mercedes-Benz Customer

Assistance Center (USA) at the hotline number 1-800-FOR-MERCEdes (1-800-367-6372) or Customer Service (Canada) at 1-800-387-0100.

Operating safety

⚠ WARNING Risk of accident due to malfunctions or system failures

If you do not have the prescribed service/maintenance work or any required repairs carried out, this could result in malfunctions or system failures.

- ▶ Always have the prescribed service/maintenance work as well any required repairs carried out at a qualified specialist workshop.

⚠ WARNING Risk of accident or injury due to incorrect modifications on electronic component parts

Modification of electronic components, their software or wiring could impair their function

and/or the function of other networked component parts. In particular, systems relevant to safety could also be affected.

As a result, these may no longer function properly and/or jeopardize the operating safety of the vehicle.

- ▶ Never tamper with the wiring and electronic component parts or their software.
- ▶ You should have all work on electrical and electronic components carried out at a qualified specialist workshop.

Observe the "On-board electronics" section in "Technical data".

⚠ WARNING Risk of fire due to flammable materials on hot parts of the exhaust system

Flammable material such as leaves, grass or twigs may ignite if they come into contact with hot parts of the exhaust system.

- ▶ When driving on unpaved roads or off-road, regularly check the vehicle underside.
- ▶ Remove trapped plants or other flammable material.
- ▶ If there is damage, consult a qualified specialist workshop immediately.

! NOTE Damage to the vehicle

In the following situations, in particular, there is a risk of damage to the vehicle:

- The vehicle becomes grounded, e.g. on a high curb or an unpaved road
- The vehicle is driven too fast over an obstacle, e.g. a curb, speed bump or pothole
- A heavy object strikes the underbody or chassis components

In situations such as this, the body, the underbody, chassis components, wheels or tires could be damaged without the damage being visible. Components damaged in this

way can unexpectedly fail or, in the case of an accident, may not absorb the loads that arise as intended.

If the underbody paneling is damaged, flammable materials such as leaves, grass or twigs can collect between the underbody and the underbody paneling. These materials may ignite if they come into contact with hot parts on the exhaust system.

▶ Have the vehicle checked and repaired immediately at a qualified specialist workshop.

or

▶ If driving safety is impaired while continuing your journey, pull over and stop the vehicle immediately in accordance with the traffic conditions, and contact a qualified specialist workshop.

Declaration of conformity for wireless vehicle components

USA: "The wireless devices of this vehicle comply with Part 15 of the FCC Rules. Operation is

subject to the following two conditions: 1) These devices may not cause harmful interference, and 2) These devices must accept any interference received, including interference that may cause undesired operation. Changes or modifications not expressly approved by the party responsible for compliance could void the user's authority to operate the equipment."

Canada: "The wireless devices of this vehicle comply with Industry Canada license-exempt RSS standard(s). Operation is subject to the following two conditions: (1) These devices may not cause interference, and (2) These devices must accept any interference, including interference that may cause undesired operation of the device."

USA: "Wireless charging system for mobile devices (Model: D-WMI2015A): this device complies with Part 18 of the FCC Rules."

The name and address of the responsible party is:

Continental Automotive Systems US Inc.
2400 Executive Hills Drive
Auburn Hills, MI 48326-2980

United States of America

Diagnostics connection

The diagnostics connection is only intended for the connection of diagnostic devices at a qualified specialist workshop.

⚠ WARNING Risk of accident due to connecting devices to the diagnostics connection

If you connect equipment to a diagnostics connection in the vehicle, it may affect the operation of vehicle systems.

As a result, the operating safety of the vehicle could be affected.

▶ Only connect equipment to a diagnostics connection in the vehicle which is approved for your vehicle by Mercedes-Benz.

⚠ WARNING Risk of accident due to objects in the driver's footwell

Objects in the driver's footwell may impede pedal travel or block a depressed pedal.

This jeopardizes the operating and road safety of the vehicle.

- ▶ Stow all objects in the vehicle securely so that they cannot get into the driver's footwell.
- ▶ Always install the floor mats securely and as prescribed in order to ensure that there is always sufficient room for the pedals.
- ▶ Do not use loose floor mats and do not place floor mats on top of one another.

! NOTE Battery discharging from using devices connected to the diagnostics connection

Using devices at the diagnostics connection drains the battery.

- ▶ Check the charge level of the battery.

- ▶ If the charge level is low, charge the battery, e.g. by driving a considerable distance.

Connecting equipment to the diagnostics connection can lead to emissions monitoring information being reset, for example. This may lead to the vehicle failing to meet the requirements of the next emissions inspection during the main inspection.

Qualified specialist workshop

An authorized Mercedes-Benz Center is a qualified specialist workshop. It has the necessary special skills, tools and qualifications to correctly carry out the work required on your vehicle. This particularly applies to safety-relevant works.

For the following, always have your vehicle checked at an authorized Mercedes-Benz Center:

- safety-relevant works
- service and maintenance work

- repair work
- modifications as well as installations and conversions
- work on electronic components

Mercedes-Benz recommends a Mercedes-Benz service center.

Correct use of the vehicle

If you remove any warning stickers, you or others could fail to recognize certain dangers. Leave warning stickers in position.

Observe the following information in particular when driving your vehicle:

- the safety notes in this manual
- technical data for the vehicle
- traffic rules and regulations
- laws and safety standards pertaining to motor vehicles

Problems with your vehicle

If you should experience a problem with your vehicle, particularly one that you believe may affect its safe operation, we urge you to contact an authorized Mercedes-Benz Center immediately to have the problem diagnosed and rectified. If the problem is not resolved to your satisfaction, please discuss the problem again with an authorized Mercedes-Benz Center or, if necessary, contact us at one of the following addresses:

In the USA:

Mercedes-Benz USA, LLC
Customer Assistance Center
One Mercedes-Benz Drive
Sandy Springs, GA 30328

In Canada:

Mercedes-Benz Canada, Inc.
Customer Relations Department
98 Vanderhoof Avenue
Toronto, Ontario M4G 4C9

Reporting safety defects

USA only:

The following text is published as required of manufacturers under Title 49, Code of U.S. Federal Regulations, Part 575 pursuant to the "National Traffic and Motor Vehicle Safety Act of 1966".

If you believe that your vehicle has a defect which could cause a crash or could cause injury or death, you should immediately inform the National Highway Traffic Safety Administration (NHTSA) in addition to notifying Mercedes-Benz USA, LLC.

If NHTSA receives similar complaints, it may open an investigation, and if it finds that a safety defect exists in a group of vehicles, it may order a recall and remedy campaign. However, NHTSA cannot become involved in individual problems between you, your dealer, or Mercedes-Benz USA, LLC.

To contact NHTSA, you may call the Vehicle Safety Hotline toll-free at 1-888-327-4236 (TTY: 1-800-424-9153) (inside the USA); go to <http://www.safercar.gov>; or write to: Adminis-

trator, NHTSA, 400 Seventh Street, SW., Washington, DC 20590, USA.

Further information on vehicle safety can be found at: <http://www.safercar.gov>

Limited Warranty

! **NOTE** Damage to the vehicle arising from violation of these operating instructions.

Damage to the vehicle can arise from violation of these operating instructions.

This damage is not covered either by the Mercedes-Benz implied warranty or by the New- or Used-Vehicle Warranty.

▶ Follow the instructions in these operating instructions on proper operation of your vehicle as well as on possible vehicle damage.

QR code for rescue card

The QR code is secured in the fuel filler flap and on the opposite side on the B-pillar. In the event of an accident, rescue services can use the QR code to quickly find the appropriate rescue card for your vehicle. The current rescue card contains the most important information about your vehicle in a compact form, e.g. the routing of the electric lines.

Further information can be obtained at <http://www.mercedes-benz.de/qrcode>.

Data storage

Electronic control units

Electronic control units are installed in your vehicle. Some of these are necessary for the safe operation of your vehicle, while some assist you when driving (driver assistance systems). In addition, your vehicle provides comfort and entertainment functions, which are also made possible by electronic control units.

Electronic control units contain data memories which can temporarily or permanently store

technical information about the vehicle's operating state, component loads, maintenance requirements and technical events or malfunctions.

In general, this information documents the state of a component part, a module, a system or the surroundings such as:

- operating status of system components (e.g. fill levels, battery status, tire pressure)
- status messages concerning the vehicle or its individual components (e.g. number of wheel revolutions/speed, longitudinal acceleration, lateral acceleration, display of fastened seat belts)
- malfunctions or faults in important system components (e.g. lights, brakes)
- information on events leading to vehicle damage
- system reactions in special driving situations (e.g. airbag deployment, intervention of stability control systems)
- ambient conditions (e.g. temperature, rain sensor)

In addition to providing the actual control unit function, this data assists the manufacturer in detecting and rectifying malfunctions and optimizing vehicle functions. The majority of this data is temporary and is only processed in the vehicle itself. Only a small portion of the data is stored in the event or malfunction memory.

When your vehicle is serviced, technical data from the vehicle can be read out by service network employees (e.g. workshops, manufacturers) or third parties (e.g. breakdown services). Services include repair services, maintenance processes, warranty claims and quality assurance measures, for example. The read out is performed via the legally prescribed port for the diagnostics connection in the vehicle. The respective service network locations or third parties collect, process and use the data. They document technical statuses of the vehicle, assist in finding malfunctions and improving quality and are transmitted to the manufacturer, if necessary. Furthermore, the manufacturer is subject to product liability. For this, the manufacturer requires technical data from vehicles.

Fault memories in the vehicle can be reset by a service outlet as part of repair or maintenance work.

Depending on the selected equipment, you can import data into the vehicle's comfort and infotainment functions yourself.

This includes, for example:

- multimedia data such as music, films or photos for playback in an integrated multimedia system
- address book data for use in connection with an integrated hands-free system or an integrated navigation system
- entered navigation destinations
- data about the use of Internet services

This data can be saved locally in the vehicle or it is located on a device which you have connected to the vehicle (e.g. smartphone, USB flash drive or MP3 player). If this data is stored in the vehicle, you can delete it at any time. This data is sent to third parties only at your request, particularly when you use online services in accordance with the settings that you have selected.

You can store or change convenience settings/individualization in the vehicle at any time.

Depending on the equipment, this includes, for example:

- settings for the seat and steering wheel positions
- suspension and climate control settings
- customizations such as interior lighting

If your vehicle is accordingly equipped, you can connect your smartphone or another mobile end device to the vehicle. You can control this by means of the control elements integrated in the vehicle. Images and audio from the smartphone can be output via the multimedia system. Certain information is simultaneously transferred to your smartphone.

Depending on the type of integration, this can include:

- general vehicle data
- position data

This allows you to use selected apps on your smartphone, such as navigation or music play-

back. There is no further interaction between the smartphone and the vehicle; in particular, vehicle data is not directly accessible. Which type of further data processing occurs is determined by the provider of the specific app used. Which settings you can make, if any, depends on the specific app and the operating system of your smartphone.

Online services

Wireless network connection

If your vehicle has a wireless network connection, it enables data to be exchanged between your vehicle and additional systems. The wireless network connection is enabled via the vehicle's transmission and reception unit or via connected mobile end devices (e.g. smartphones). Online functions can be used via the wireless network connection. This includes online services and applications/apps provided by the manufacturer or other providers.

Manufacturer's services

Regarding online services of the manufacturer, the individual functions are described by the

manufacturer in a suitable place (e.g. Operator's Manual, website of the manufacturer) along with the relevant data protection information. Personal data may be used for the provision of online services. Data is exchanged via a secure connection, e.g. the manufacturer's designated IT systems. Personal data is collected, processed and used via the provision of services exclusively on the basis of legal permissions or with prior consent.

The services and functions (sometimes subject to a fee) can usually be activated or deactivated. In some cases, this also applies to the entire vehicle's data connection. This excludes, in particular, legally prescribed functions and services.

Third party services

If it is possible to use online services from other providers, these services are subject to the data protection and terms of use of the responsible provider. The manufacturer has no influence on the content exchanged.

Please inquire, therefore, about the type, scope and purpose of the collection and use of per-

sonal data as part of third party services from their respective provider.

Multimedia system/Mercedes me connect

If the vehicle is equipped with the multimedia system or Mercedes me connect, additional data about the vehicle's operation, the use of the vehicle in certain situations, and the location of the vehicle may be compiled by the multimedia system or Mercedes me connect.

For additional information please refer to the chapter "Multimedia system" and/or the Mercedes me connect Terms and Conditions.

Event data recorders

USA only:

This vehicle is equipped with an event data recorder (EDR). The main purpose of an EDR is to record, in certain crash or near crash-like situations, such as an airbag deployment or hitting a road obstacle, data that will assist in understanding how a vehicle's systems performed. The EDR is designed to record data related to

vehicle dynamics and safety systems for a short period of time, typically 30 seconds or less.

The EDR in this vehicle is designed to record such data as:

- How various systems in your vehicle were operating
- Whether or not the driver and front passenger seat belts were buckled/fastened
- How far (if at all) the driver was depressing the accelerator and/or brake pedal and
- How fast the vehicle was traveling

This data can help provide a better understanding of the circumstances in which accidents and injuries occur. NOTE: EDR data is recorded by your vehicle only if a non-trivial crash situation occurs; no data is recorded by the EDR under normal driving conditions and no personal data (e.g. name, gender, age and accident location) is recorded. However, other parties, such as law enforcement, could combine EDR data with the type of personally identifying data routinely acquired during a crash investigation.

Access to the vehicle and/or the EDR is needed to read data that is recorded by the EDR, and special equipment is required. In addition to the vehicle manufacturer, other parties that have the special equipment, such as law enforcement, can read the information by accessing the vehicle or the EDR.

EDR data may be used in civil and criminal matters as a tool in accident reconstruction, accident claims and vehicle safety. Since the Crash Data Retrieval (CDR) tool that is used to extract data from the EDR is commercially available, Mercedes-Benz USA, LLC ("MBUSA") expressly disclaims any and all liability arising from the extraction of this information by unauthorized Mercedes-Benz personnel.

MBUSA will not share EDR data with others without the consent of the vehicle owner or, if the vehicle is leased, without the consent of the lessee. Exceptions to this representation include responses to subpoenas by law enforcement; by federal, state or local government; in connection with or arising out of litigation involving MBUSA or its subsidiaries and affiliates; or, as required by law.

Warning: the EDR is a component of the Restraint System Module. Tampering with, altering, modifying or removing the EDR component may result in a malfunction of the Restraint System Module and other systems.

State laws or regulations regarding EDRs that conflict with federal regulation are pre-empted. This means that in the event of such conflict, the federal regulation governs. As of December 2016, 17 states have enacted laws relating to EDRs.

Copyright

Free and open source software

Information on free and open source software licenses for your vehicle's software can be found on the data storage medium in your vehicle document wallet and on the Internet together with updates:

<http://www.mercedes-benz.com/opensource>

Registered trademarks

- Bluetooth® is a registered trademark of Bluetooth SIG Inc.
- DTS™ is a registered trademark of DTS, Inc.
- Dolby® and MLP™ are registered trademarks of DOLBY Laboratories.
- BabySmart™, ESP® and PRE-SAFE® are registered trademarks of Daimler AG.
- HomeLink® is a registered trademark of Johnson Controls.
- iPod® and iTunes® are registered trademarks of Apple Inc.
- Burmester® is a registered trademark of Burmester Audiosysteme GmbH.
- Microsoft® and Windows Media® are registered trademarks of Microsoft Corporation.
- SIRIUS® is a registered trademark of Sirius XM Radio Inc.
- HD Radio™ is a registered trademark of iBiquity Digital Corporation.

- Gracernote® is a registered trademark of Gracernote, Inc.
- ZAGATSurvey® and related brands are registered trademarks of ZagatSurvey, LLC.

Restraint system

Protection by the restraint system

The restraint system includes the following components:

- Seat belt system
- Airbags
- Child restraint system
- Child seat securing system

The restraint system can reduce the risk of vehicle occupants coming into contact with parts of the vehicle's interior in the event of an accident. The restraint system can also reduce the forces to which vehicle occupants are subjected in the event of an accident.

Only a seat belt which is worn correctly can provide the intended level of protection. Depending on the detected accident situation, Emergency Tensioning Devices and/or airbags supplement a correctly worn seat belt. Emergency Tensioning Devices and/or airbags are not deployed in every accident.

For the restraint system to provide its full protection, each occupant must observe the following:

- Fasten the seat belt correctly.
- Be in an almost upright position with their back against the seat backrest.
- Sit with their feet resting on the floor, if possible.
- Always secure persons under 5 ft (1.50 m) tall in an additional restraint system suitable for Mercedes-Benz vehicles.

However, no system available today can completely eliminate injuries and fatalities in every accident situation. In particular, the seat belt and airbag generally do not protect against objects penetrating the vehicle from the outside. The risk of an injury resulting from airbag deployment also cannot be ruled out entirely.

Limited protection from the restraint system

⚠ WARNING Risk of injury or death from modifications to the restraint system

The restraint system can no longer function correctly after alterations have been made.

The restraint system may then not protect the vehicle occupants as intended by failing in an accident or triggering unexpectedly, for example

- ▶ Never alter the parts of the restraint system.
- ▶ Never tamper with the wiring or any electronic component parts or their software.

If it is necessary to adjust the vehicle to accommodate a person with disabilities, contact an authorized Mercedes-Benz Center for details.



USA only: for further information contact our Customer Assistance Center at 1-800-FOR-MERCEdes (1-800-367-6372).

Restraint system functionality

When the ignition is switched on, a self-test is performed, during which the  restraint system warning lamp lights up. It goes out no later than a few seconds after the vehicle is started. The components of the restraint system are then functional.

Malfunctioning restraint system

A malfunction has occurred in the restraint system if:

- the  restraint system warning lamp does not light up when the ignition is switched on
- the  restraint system warning lamp lights up continuously or repeatedly during a journey

⚠ WARNING Risk of injury or fatal injury due to a malfunction in the restraint system

If the restraint system is malfunctioning, restraint system components may be trig-

gered unintentionally or might not be triggered at all in the event of an accident. This may affect the Emergency Tensioning Device or airbag, for example.

- ▶ Have the restraint system checked and repaired immediately at a qualified specialist workshop.

Function of the restraint system in an accident

How the restraint system works is determined by the severity of the impact detected and the type of accident anticipated:

- Frontal impact
- Rear impact
- Side impact
- Rollover

The activation thresholds for the components of the restraint system are determined based on the evaluation of the sensor values measured at various points in the vehicle. This process is pre-emptive in nature. The triggering/deployment of

the components of the restraint system must take place in good time at the start of the collision.

Factors which can only be seen and measured after a collision has occurred do not play a decisive role in the deployment of an airbag. Nor do they provide an indication of airbag deployment.

The vehicle may be deformed significantly without an airbag being deployed. This is the case if only parts which are relatively easily deformed are affected and the rate of vehicle deceleration is not high. Conversely, an airbag may be deployed even though the vehicle suffers only minor deformation. If very rigid vehicle parts such as longitudinal members are hit, for example, this may result in sufficiently high levels of vehicle deceleration.

The components of the restraint system can be activated or deployed independently of each other:

Component	Detected deployment situation
Emergency Tensioning Devices	Frontal impact, rear impact, side impact, rollover
Driver's airbag, front passenger front airbag	Frontal impact
Knee airbag	Frontal impact
Side airbag	Side impact
Window curtain airbag	Side impact, rollover, frontal impact

The front passenger front airbag can only be deployed in an accident if the PASSENGER AIR BAG OFF indicator lamp is off. If the front passenger seat is occupied, make sure, both before and during the journey, that the status of

the front passenger front airbag is correct (→ page 43).

⚠ WARNING Risk of burns from hot air bag components

The air bag parts are hot after an air bag has been deployed.

- ▶ Do not touch the air bag parts.
- ▶ Have a deployed air bag replaced at a qualified specialist workshop as soon as possible.

Mercedes-Benz recommends that you have the vehicle towed to a qualified specialist workshop after an accident. Take this into account, particularly if an Emergency Tensioning Device is triggered or an airbag deployed.

If the Emergency Tensioning Devices are triggered or an airbag is deployed, you will hear a bang, and a small amount of powder may also be released:

- The bang will not generally affect your hearing.

- In general, the powder released is not hazardous to health but may cause short-term breathing difficulties to persons suffering from asthma or other pulmonary conditions. Provided it is safe to do so, leave the vehicle immediately or open the window in order to prevent breathing difficulties.

Airbags and pyrotechnic Emergency Tensioning Devices contain perchlorate material, which may require special handling or environmental protection measures. National guidelines regarding waste disposal must be observed. In California, see <http://www.dtsc.ca.gov/HazardousWaste/Perchlorate/index.cfm>.

Seat belts

Protection provided by the seat belt

Always fasten your seat belt correctly before starting a journey. A seat belt can only provide the best level of protection if it is worn correctly.

▲ WARNING Risk of injury or death due to incorrectly fastened seat belt

If the seat belt is not worn correctly, it cannot perform its intended protective function. In addition, an incorrectly fastened seat belt can also cause injuries, for example, in the event of an accident or when braking or changing direction suddenly.

- ▶ Always ensure that all vehicle occupants have their seat belts fastened correctly and are sitting properly.

Always observe the instructions about the correct driver's seat position and adjusting the seat (→ page 79).

In order for the correctly worn seat belt to provide the intended level of protection, each vehicle occupant must observe the following information:

- The seat belt must not be twisted and must fit tightly and snugly across the body.

- The seat belt must be routed across the center of the shoulder and as low down across the hips as possible.
- The shoulder section of the seat belt should not touch your neck nor be routed under your arm or behind your back.
- Avoid wearing bulky clothing, e.g. a winter coat.
- Push the lap belt down as far as possible across your hips and pull tight with the shoulder section of the belt. Never route the lap belt across your abdomen.
- Never route the seat belt across sharp, pointed, abrasive or fragile objects.
- Only one person should use each seat belt at any one time. Never allow babies and children to travel sitting on the lap of another vehicle occupant.
- Never secure objects with a seat belt if the seat belt is also being used by one of the vehicle's occupants. Always observe the instructions for loading the vehicle when securing objects, luggage or loads (→ page 90).

Also ensure that no objects, e.g. a cushion, are ever placed between a person and the seat.

The seat belts on the following seats are equipped with a special seat belt retractor:

- front-passenger seat
- Rear seats

Activate or deactivate the special seatbelt retractor (→ page 52).

If children are traveling in the vehicle, be sure to observe the instructions and safety notes on "Children in the vehicle" (→ page 47).

Reduced seat belt protection

▲ WARNING Risk of injury or death due to incorrect seat position

The seat belt does not offer the intended level of protection if you have not moved the seat backrest to an almost vertical position.

When braking or in the event of an accident, you could slide underneath the seat belt and sustain abdominal or neck injuries, for example.

- ▶ Adjust the seat properly before beginning your journey.
- ▶ Always ensure that the seat backrest is in an almost vertical position and that the shoulder section of your seat belt is routed across the center of your shoulder.

⚠ WARNING Risk of injury or death when additional restraint systems are not used for persons with a smaller build

Persons under 5 ft (1.50 m) tall cannot wear the seat belt correctly without a suitable additional restraint system.

If the seat belt is not worn correctly, it cannot perform its intended protective function. In addition, an incorrectly fastened seat belt can also cause injuries, for example, in the

event of an accident or when braking or changing direction suddenly.

- ▶ Always secure persons under 5 ft (1.50 m) tall in a suitable restraint system.

⚠ WARNING Danger of injury or death due to blocked seat belt anchorages

The restraint effect of the seat belt is impaired if objects between the front seat and the door are blocking the movable seat belt anchorage on the front seat.

The seat belt may not then provide the proper protection.

- ▶ Before starting a journey, make sure that there are no objects between the front seat and the door.

⚠ WARNING Risk of injury or death due to damaged or modified seat belts

Seat belts cannot provide protection in the following situations:

- If the seat belts are damaged, modified, extremely dirty, bleached or dyed
- If the seat belt buckle is damaged or extremely dirty
- If the Emergency Tensioning Devices, seat belt anchorages or seat belt retractors have been modified

Seat belts may be damaged in an accident, although the damage may not be visible, e.g. due to splinters of glass.

Modified or damaged seat belts may tear or fail, e.g. in an accident.

Modified Emergency Tensioning Devices can accidentally trigger or fail to function as intended.

- ▶ Never modify the seat belts, Emergency Tensioning Devices, seat belt anchorages or seat belt retractors.

- ▶ Make sure that the seat belts are undamaged, not worn and clean.
- ▶ Always have the seat belts checked immediately after an accident at a qualified specialist workshop.

Only use seat belts which have been approved for your vehicle by Mercedes-Benz.

⚠ WARNING Risk of injury or death from deployed pyrotechnic Emergency Tensioning Devices

Pyrotechnic Emergency Tensioning Devices that have been deployed are no longer operational and are unable to perform their intended protective function.

- ▶ Therefore, have deployed pyrotechnic Emergency Tensioning Devices immediately replaced at a qualified specialist workshop.

Mercedes-Benz recommends that you have the vehicle towed to a qualified specialist workshop after an accident.

! NOTE Damage caused by trapping the seat belt

If an unused seat belt is not fully retracted, it may become trapped in the door or in the seat mechanism.

- ▶ Always ensure that an unused seat belt is fully retracted.

Fastening and adjusting the seat belts

If the seat belt is pulled quickly or sharply, the seat belt retractor locks. The seat belt strap cannot be pulled out any further.

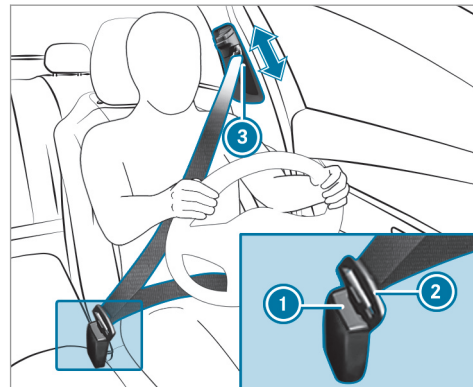

- ▶ Always engage seat belt tongue ② of the seat belt into seat belt buckle ① of the corresponding seat.
- ▶ Press and hold the seat belt outlet release and slide seat belt outlet ③ into the desired position.
- ▶ Let go of the seat belt outlet release and ensure that seat belt outlet ③ locks into position.

Vehicles with automatic front passenger front airbag shutoff:

! **NOTE** Deployment of the Emergency Tensioning Device and side air bag when the front passenger seat is unoccupied

If the seat belt tongue is engaged in the seat belt buckle of the unoccupied front passenger seat, the Emergency Tensioning Device and the side air bag may also deploy in the event of an accident along with other systems.

▶ Only one person should use each seat belt at any one time.

Vehicles without automatic front passenger front airbag shutoff:

! **NOTE** Deployment of the Emergency Tensioning Device when the front-passenger seat is unoccupied

If the seat belt tongue is engaged in the seat belt buckle of the unoccupied front-passenger seat, the Emergency Tensioning

Device may also deploy in the event of an accident along with other systems.

▶ Only one person should use each seat belt at any one time.

Left and right rear seat:

! **NOTE** Triggering the Emergency Tensioning Device when the rear seat is unoccupied

If the seat belt tongue is engaged in the seat belt buckle of the unoccupied rear seat, the rear Emergency Tensioning Device may also trigger in addition to other systems in the event of an accident.

▶ Only one person should use each seat belt at any one time.

Seat belt adjustment function

Vehicles with PRE-SAFE®: If the front seat belt is not pulled tight across your body, the seat belt adjustment may automatically apply a certain

tightening force. Do not hold the seat belt tightly while it is adjusting.

You can activate and deactivate the seat belt adjustment function using the multimedia system (→ page 37).

Releasing seat belts

▶ Press the release button in the seat belt buckle and guide the seat belt back with the seat belt tongue.

Activating/deactivating seat belt adjustment via the multimedia system

Multimedia system:

↳ Vehicle ▶  Vehicle Settings
▶ Belt Adjustment

▶ Activate or deactivate the function.

Seat belt warning function for the driver and front passenger

The  seat belt warning lamp in the Instrument Display is a reminder that all vehicle occupants must wear their seat belts correctly.

The  seat belt warning lamp lights up for six seconds every time the vehicle is started.

In addition, a warning tone may sound.

When the driver's and front passenger's doors are closed and the driver and front passenger have fastened their seat belts, the seat belt warning goes out.

In the following cases, the seat belt warning lights up during a journey if:

- The vehicle speed exceeds 15 mph (25 km/h) and the driver's or front passenger seat belt is not fastened.
- The driver or front passenger unfastens their seat belt while the vehicle is in motion.

Airbags

Overview of airbags

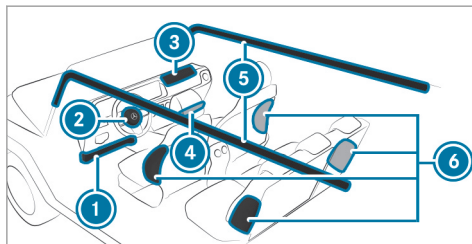

- 1 Driver's knee bag
- 2 Driver's airbag
- 3 Front passenger front airbag
- 4 Front passenger knee airbag
- 5 Window curtain airbag
- 6 Side airbag

The installation location of an airbag is identified by the AIRBAG symbol.

When activated, an airbag can provide additional protection for the respective vehicle occupant.

Potential protection from each airbag:

Airbag	Potential protection for ...
Knee airbag	Thigh, knee and lower leg
Driver's airbag, front passenger front airbag	Head and ribcage
Window curtain airbag	Head
Side airbag	Ribcage, also pelvis for front seat occupants

The front passenger front airbag can only be deployed in an accident if the PASSENGER AIR BAG OFF indicator lamp is off. If the front passenger seat is occupied, make sure, both before and during the journey, that the status of the front passenger front airbag is correct (→ page 43).

! **NOTE** Important points to remember if the front passenger seat is unoccupied

In an accident, the components of the restraint system may deploy unnecessarily on the front passenger side if:

- There are heavy objects on the front passenger seat.
- The seat belt tongue is engaged in the seat belt buckle of the front passenger seat and the front passenger seat is unoccupied.

- ▶ Stow objects in a suitable place.
- ▶ Only one person should use each seat belt at any one time.

Protection by the airbags

Depending on the accident situation, an airbag may supplement the protection offered by a correctly fastened seat belt.

! **WARNING** Risk of injury or death due to incorrect seat position

If you deviate from the correct seat position, the air bag cannot perform its intended protective function and deployment may even cause further injuries.

To avoid hazardous situations, always make sure that all vehicle occupants:

- Have their seat belt fastened correctly, including pregnant women.
- Are seated properly and that distance to the air bags is as large as possible.
- Observe the following information.
- ▶ Always make sure that there are no objects between the air bag and the vehicle occupant.

To avoid the risks resulting from the deployment of an airbag, each vehicle occupant must observe the following information:

- Before starting your journey, adjust your seat correctly; the driver's seat and front-

passenger seat should be moved as far back as possible.

When doing so, always observe the information on the correct driver's seat position (→ page 79).

- Only hold the steering wheel by the steering wheel rim. This allows the airbag to be fully deployed.
- Always lean against the seat backrest when the vehicle is in motion. Do not lean forwards or against the door or side window. You may otherwise be in the deployment area of the airbags.
- Always keep your feet on the floor. Do not put your feet on the cockpit, for example. Your feet may otherwise be in the deployment area of the airbag.
- If children are traveling in the vehicle, observe the additional notes (→ page 47).
- Always stow and secure objects correctly.

Objects in the vehicle interior may prevent an airbag from functioning correctly. Each vehicle occupant must always make sure of the following:

- There are no people, animals or objects between the vehicle occupants and an airbag.
- There are no objects between the seat, door and door pillar (B-pillar).
- There are no hard objects, e.g. coat hangers, hanging on the grab handles or coat hooks.
- There are no accessory parts, such as PNDs (Personal Navigation Devices), mobile phones or cup holders attached to the vehicle within the deployment area of an airbag, e.g. on the cockpit, on doors, side windows or side paneling.

In addition, no connecting cable, tensioning strap or retaining strap may be routed through or attached in the deployment area of an airbag. Always observe the accessory manufacturer's installation instructions, in particular the information on suitable places for installation.

- There are no heavy, sharp-edged or fragile objects in the pockets of your clothing. Store such objects in a suitable place.

Limited protection from airbags

⚠ WARNING Risk of injury due to modifications to the airbag cover

If you modify the cover of an airbag or affix objects such as stickers to it, the airbag may no longer function correctly.

- ▶ Never modify the cover of an airbag and do not affix objects to it.

The installation location of an airbag is identified by the AIRBAG symbol (→ page 38).

⚠ WARNING Risk of injury or death due to the use of unsuitable seat covers

Unsuitable seat covers can obstruct or prevent the deployment of air bags integrated into the seats.

Consequently, the air bags cannot protect vehicle occupants as they are designed to do. In addition, operation of the automatic front passenger air bag shutoff may be restricted.

- ▶ You should only use seat covers that have been approved for the corresponding seats by Mercedes-Benz.

⚠ WARNING Risk of injury due to malfunctions of the sensors in the door paneling

Sensors to control the airbags are located in the doors. Modifications or work not performed correctly to the doors or door paneling, as well as damaged doors, can lead to the function of the sensors being impaired. The airbags might therefore not function properly any more.

Consequently, the airbags cannot protect vehicle occupants as they are designed to do.

- ▶ Never modify the doors or parts of the doors.

- ▶ Always have work on the doors or door paneling carried out at a qualified specialist workshop.

⚠ WARNING Risk of injury due to deployed airbag

A deployed airbag no longer has a protective function and cannot protect as intended in the event of an accident.

- ▶ Have the vehicle towed to a qualified specialist workshop in order to have the deployed airbag replaced.

Have deployed airbags replaced immediately.

Status of the front passenger front airbag

Function of the automatic front passenger front airbag shutoff

The automatic front passenger front airbag shutoff is able to detect whether the front passenger seat is occupied by a person or a child restraint system. The front passenger front airbag and

front passenger knee airbag are enabled or disabled accordingly.

In the following situation, the side airbag and the Emergency Tensioning Device are deactivated:

- The automatic front passenger front airbag shutoff has not categorized the person in the front passenger seat as an adult or a person of corresponding stature and
- The seat belt tongue is not inserted into the seat belt buckle on the front passenger seat

When installing a child restraint system on the front passenger seat, always make sure of the following:

- Ensure that the child restraint system is positioned correctly (→ page 46).
- Always observe the child restraint system manufacturer's installation instructions.
- Never place objects, e.g. cushions, under or behind the child restraint system.
- Fully retract the seat cushion length adjustment.

- The entire base of the child restraint system must always rest on the seat cushion of the front passenger seat.
- The backrest of the forward-facing child restraint system must lie as flat as possible against the backrest of the front passenger seat.
- The child restraint system must not touch the roof or be put under strain by the head restraints. Adjust the seat backrest inclination and the head restraint setting accordingly.

⚠ WARNING Risk of injury or death due to objects between the sitting surface and the child restraint system

Objects between the sitting surface and the child restraint system could affect the function of the automatic front passenger airbag shutoff.

This could result in the front passenger airbag not functioning as intended during an accident.

- ▶ Do not place any objects between the sitting surface and the child restraint system.
- ▶ The entire base of the child restraint system must always rest on the sitting surface of the front passenger seat.
- ▶ The backrest of the forward-facing child restraint system must, as far as possible, be resting on the seat backrest of the front passenger seat.
- ▶ Always comply with the child restraint system manufacturer's installation instructions.

A person on the front passenger seat must observe the following information:

- Fasten seat belts correctly (→ page 33).
- Sit in an almost upright seat position with their back against the seat backrest.
- Sit with their feet resting on the floor, if possible.

The front passenger front airbag may otherwise be disabled by mistake, for example in the following situations:

- The front passenger transfers their weight by supporting themselves on a vehicle armrest.
- The front passenger sits in such a way that their weight is raised from the sitting surface.

⚠ WARNING Risk of injury or death due to deactivated front passenger airbag

If the PASSENGER AIR BAG OFF indicator lamp is lit, the front passenger airbag is disabled. It will not be deployed in the event of an accident and cannot perform its intended protective function.

A person in the front passenger seat could then, for example, come into contact with the vehicle interior, especially if the person is sitting too close to the cockpit.

If the front passenger seat is occupied, always ensure that:

- The classification of the person in the front passenger seat is correct and the front passenger airbag is enabled or disabled in accordance with the person in the front passenger seat.
 - The front passenger seat has been moved as far back as possible.
 - The person is seated correctly.
- ▶ Ensure, both before and during the journey, that the status of the front passenger airbag is correct.

If the front passenger seat is occupied, the classification of the person or child restraint system on the front passenger seat takes place after the front passenger front airbag shutoff self-test. The PASSENGER AIR BAG indicator lamps display the status of the front passenger front airbag.

Always observe the notes on the function of the PASSENGER AIR BAG indicator lamps (→ page 43).

Function of the PASSENGER AIR BAG indicator lamps

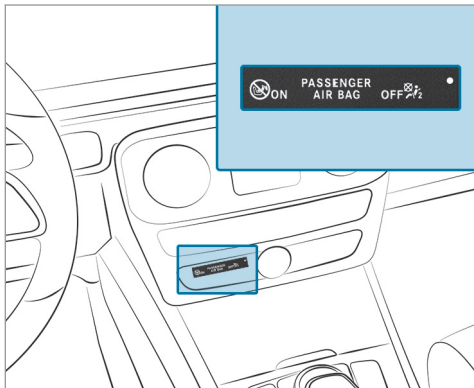

Self-test of automatic front passenger front airbag shutoff

When the ignition is switched on, a self-test is performed during which the two PASSENGER AIR BAG ON and OFF indicator lamps light up simultaneously.

The status of the front passenger front airbag is displayed after the self-test:

- PASSENGER AIR BAG ON lights up for 60 seconds, subsequently both indicator lamps are off (PASSENGER AIR BAG ON and OFF): the front passenger front airbag is able to deploy in the event of an accident.
- PASSENGER AIR BAG OFF lights up continuously: the front passenger front airbag is disabled. It will then not be deployed in the event of an accident.

If the PASSENGER AIR BAG ON indicator lamp is off, only the PASSENGER AIR BAG OFF indicator lamp shows the status of the front passenger front airbag. The PASSENGER AIR BAG OFF indicator lamp may be lit continuously or be off.

If the PASSENGER AIR BAG OFF indicator lamp and the  restraint system warning lamp light up simultaneously, the front passenger seat may not be used. Also in this case, do not install a child restraint system on the front passenger seat. Have automatic front passenger front airbag shutoff checked and repaired immediately at a qualified specialist workshop.

Status display

If the front passenger seat is occupied, ensure, both before and during the journey, that the status of the front passenger front airbag is correct for the current situation.

After installing a rearward-facing child restraint system on the front passenger seat: PASSENGER AIR BAG OFF must be lit continuously.

⚠ WARNING Risk of injury or death from using a rearward-facing child restraint system when the front passenger front airbag is enabled

If you secure a child in a rearward-facing child restraint system on the front passenger seat and the PASSENGER AIR BAG OFF indicator lamp is off, the front passenger airbag can deploy in the event of an accident.

The child could be struck by the airbag.

Always ensure that the front passenger airbag is deactivated. The PASSENGER AIR BAG OFF indicator lamp must be lit.

NEVER use a rearward-facing child restraint system on a seat protected by an ENABLED FRONT AIRBAG in front of it, DEATH or SERIOUS INJURY to the CHILD can occur.

When installing a child restraint system on the front passenger seat, observe the vehicle-specific information (→ page 57).

Depending on the child restraint system and the stature of the child, the PASSENGER AIR BAG OFF indicator lamp may be off. In this case, do not install the rearward-facing child restraint system on the front passenger seat.

Instead, install the rearward-facing child restraint system on a suitable rear seat.

After installing a forward-facing child restraint system on the front passenger seat: depending on the child restraint system and the stature of the child, PASSENGER AIR BAG OFF may be lit continuously or be off. Always observe the following information.

⚠ WARNING Risk of injury or death due to incorrect positioning of the forward-facing child restraint system

If you secure a child in a forward-facing child restraint system on the front passenger seat and you position the front passenger seat too close to the cockpit, in the event of an accident, the child could:

- Come into contact with the vehicle interior if the PASSENGER AIR BAG OFF indicator lamp is lit, for example.
- Be struck by the air bag if the PASSENGER AIR BAG OFF indicator lamp is off.

▶ Always move the front passenger seat as far back as possible and fully retract the seat cushion length adjustment. Always make sure that the shoulder belt strap is correctly routed from the seat belt outlet on the vehicle to the shoulder belt guide on the child restraint system. The shoulder belt strap must be routed forwards and downwards from the vehicle belt outlet. If necessary,

adjust the seat belt outlet and the front passenger seat accordingly.

▶ Always observe the child restraint system manufacturer's installation instructions.

When installing a child restraint system on the front passenger seat, observe the vehicle-specific information (→ page 57).

If a person is sitting on the front passenger seat: PASSENGER AIR BAG OFF may be lit continuously or be off, depending on the person's stature.

A person on the front passenger seat must always observe the following information:

- If the front passenger seat is occupied by an adult or a person with a stature corresponding to that of an adult, the PASSENGER AIR BAG OFF indicator lamp must be off. This indicates that the front passenger front air-bag is enabled.

If the PASSENGER AIR BAG OFF indicator lamp is lit continuously, an adult or person

with a build corresponding to that of an adult should not use the front passenger seat.

Instead, they should use a rear seat.

- If the front passenger seat is occupied by a person of smaller stature (e.g. a teenager or small adult), the PASSENGER AIR BAG OFF indicator lamp either lights up continuously or remains off, depending on the result of the classification.
 - If the PASSENGER AIR BAG OFF indicator lamp is off: move the front passenger seat as far back as possible, or the person of smaller stature should use a rear seat.
 - If the PASSENGER AIR BAG OFF indicator lamp is lit continuously: the person of smaller stature should not use the front passenger seat.

⚠ WARNING Risk of injury or death when the PASSENGER AIR BAG OFF indicator lamp is lit

If the PASSENGER AIR BAG OFF indicator lamp remains lit after the system self-test, the front passenger air bag is deactivated. It will not be deployed in the event of an accident. In this case, the front passenger air bag cannot perform its intended protective function, e.g. when a person is seated in the front passenger seat.

That person could, for example, come into contact with the vehicle interior, especially if the person is sitting too close to the cockpit.

If the front passenger seat is occupied, always ensure that:

- The classification of the person in the front passenger seat is correct and the front passenger air bag is enabled or deactivated in accordance with the person in the front passenger seat.

- The person is seated properly with a correctly fastened seat belt.
- The front passenger seat has been moved as far back as possible.

Be sure to also observe the following further related subjects:

- Child restraint system on the front passenger seat (→ page 57).

PRE-SAFE® system

PRE-SAFE® (anticipatory occupant protection)

PRE-SAFE® is able to detect certain critical driving situations and implement pre-emptive measures to protect the vehicle occupants.

PRE-SAFE® can implement the following measures independently of each other:

- Tightening the seat belts on the driver's seat and front passenger seat.
- Closing the side windows.

- **Vehicles with sliding sunroof:** Closing the sliding sunroof.
- **Vehicles with memory function:** Moving the front passenger seat to a more favorable seat position.
- **Vehicles with multicontour seat:** Increasing the air pressure in the seat side bolsters of the seat backrest.
- **PRE-SAFE® Sound:** provided that the multimedia system is switched on, generates a brief noise signal to stimulate the innate protective mechanism of a person's hearing.

! **NOTE** Damage caused by objects in the footwell or behind the seat

The automatic adjustment of the seat position may result in damage to the seat and/or the object.

▶ Stow objects in a suitable place.

Reversing the PRE-SAFE® system measures

If an accident did not occur, the pre-emptive measures that were taken are reversed.

You will need to perform certain settings yourself.

- ▶ If the seat belt pre-tensioning is not reduced, move the seat backrest back slightly. The locking mechanism releases.

Safely transporting children in the vehicle

Always observe when children are traveling in the vehicle

- ⓘ Also strictly observe the safety notes for the specific situation. In this way you can recognize potential risks and avoid dangers if children are traveling in the vehicle (→ page 47).

Be diligent

Bear in mind that neglecting to secure a child in the child restraint system may have serious consequences. Always be diligent in securing a child carefully before every journey.

To improve protection for children younger than 12 years old or under 5 ft (1.50 m) in height, Mercedes-Benz recommends you observe the following information:

- Always secure the child in a child restraint system suitable for this Mercedes-Benz vehicle.
- The child restraint system must be appropriate to the age, weight and size of the child.
- The vehicle seat must be suitable for installing a child restraint system.

Accident statistics show that children secured in the rear seats are generally safer than children secured in the front seats. For this reason, Mercedes-Benz strongly advises that you install a child restraint system on a rear seat.

Generic term "child restraint system"

The generic term child restraint system is used in this Operator's Manual. A child restraint system is, for example:

- a baby car seat
- a rearward-facing child seat

- a forward-facing child seat
- a child booster seat with a backrest and seat belt guide

Mercedes-Benz recommends using a child booster seat with a backrest.

The child restraint system must be appropriate to the age, weight and size of the child.

Observing laws and legal requirements

Always observe the legal requirements when using a child restraint system in the vehicle.

Observing standards for child restraint systems

All child restraint systems must meet the following standards:

- U.S. Federal Motor Vehicle Safety Standards 213 and 225
- Canadian Motor Vehicle Safety Standards 213 and 210.2

Confirmation that the child restraint system complies with the standards can be found on an instruction label on the child restraint system. This confirmation can also be found in the instal-

lation instructions that are included with the child restraint system.

Detecting risks, avoiding danger

Securing systems for child restraint systems in the vehicle

Only use the following securing systems for child restraint systems:

- the LATCH-type (ISOFIX) mounting brackets
- the vehicle's seat belt system
- the Top Tether anchorages

Installing a LATCH-type (ISOFIX) child restraint system is preferred.

Simply attaching to the securing rings on the vehicle can reduce the risk of installing the child restraint system incorrectly.

When securing a child with the integrated seat belt of the LATCH-type (ISOFIX) child restraint system, always comply with the permissible gross weight for the child and child restraint system (→ page 53).

A booster seat may be necessary to achieve proper seat belt positioning for children over 40 lbs (18 kg) in weight or until they reach a height where a three-point seat belt can be installed properly without a booster seat.

Mercedes-Benz recommends a suitable child booster seat with a backrest and seat belt guide.

Advantage of a rearward-facing child restraint system

It is preferable to transport a baby or a small child in a suitable rearward-facing child restraint system. In this case, the child sits in the opposite direction to the direction of travel and faces backwards.

Babies and small children have comparatively weak neck muscles in relation to the size and weight of their head. The risk of injury to the cervical spine during an accident can be reduced in a rearward-facing child restraint system.

Always secure a child restraint system correctly

▲ WARNING Risk of injury or death caused by incorrect installation of the child restraint system

If the child restraint system is incorrectly installed on a suitable seating position, it cannot perform its intended protective function.

The child cannot be restrained in the event of an accident, heavy braking or a sudden change of direction.

- ▶ Always comply with the manufacturer's installation instructions for the child restraint system and its correct use.
- ▶ Make sure that the entire base of the child restraint system always rests on the sitting surface of the seat.
- ▶ Never place objects under or behind the child restraint system, e.g. cushions.

- ▶ Always use child restraint systems with the original cover designed for them.
- ▶ Always replace damaged covers with genuine covers.

▲ WARNING Risk of injury or death from unsecured child restraint systems in the vehicle

If the child restraint system is not correctly installed or secured, it could release in the event of an accident, sudden braking or a sudden change in direction.

The child restraint system could be flung around and hit vehicle occupants.

- ▶ Always install child restraint systems correctly, even when not in use.
 - ▶ Always comply with the child restraint system manufacturer's installation instructions.
- Always observe the child restraint system manufacturer's installation and operating

instructions as well as the vehicle-specific information:

- Install the LATCH-type (ISOFIX) child restraint system on the rear seat (→ page 53).
 - Secure the child restraint system with the seat belt on the rear seat (→ page 56).
 - Secure the child restraint system with the seat belt on the front passenger seat (→ page 58). Observe the specific instructions for the rearward-facing and forward-facing child restraint systems (→ page 57).
- If the front passenger seat is occupied, ensure, both before and during the journey, that the status of the front passenger front airbag is correct for the current situation (→ page 43).
- Observe the warning labels in the vehicle interior and on the child restraint system.
 - Also secure Top Tether if present.

Do not modify the child restraint system

⚠ WARNING Risk of injury due to modifications to the child restraint system

The child restraint system may no longer function as it is supposed to if you make modifications or attach objects to it, e.g. toys or unsuitable accessories. This poses an increased risk of injury!

Never modify the child restraint system. Only attach accessories which the manufacturer of the child restraint system has authorized especially for this child restraint system.

Only use child restraint systems which are in proper working condition

⚠ WARNING Risk of injury or death caused by the use of damaged child restraint systems

Child restraint systems or their retaining systems that have been subjected to a load in an accident may then not be able to perform their intended protective function.

The child cannot be restrained in the event of an accident, heavy braking or a sudden change of direction.

- ▶ Always replace child restraint systems immediately that have been damaged or involved in an accident.
- ▶ Have the securing systems for the child restraint systems checked at a qualified specialist workshop before installing a child restraint system again.

Avoiding direct sunlight

⚠ WARNING Risk of burns when the child seat is exposed to direct sunlight

If the child restraint system is exposed to direct sunlight or heat, parts could heat up. Children could suffer burns from these parts, particularly on metallic parts of the child restraint system.

- ▶ Always make sure that the child restraint system is not exposed to direct sunlight.

- ▶ Protect it with a blanket, for example.
- ▶ If the child restraint system has been exposed to direct sunlight, allow it to cool before securing a child into it.
- ▶ Never leave children unattended in the vehicle.

Observe when stopping or parking

⚠ WARNING Risk of accident and injury due to children and animals left unattended in the vehicle

If you leave children and animals unattended in the vehicle, they may be able to set the vehicle in motion, for example by:

- Releasing the parking brake.
- Shifting the automatic transmission out of park position **P**.
- Starting the engine.

In addition, they may operate vehicle equipment and become trapped.

- ▶ Never leave children and animals unattended in the vehicle.
- ▶ When leaving the vehicle, always take the SmartKey with you and lock the vehicle.

▲ WARNING Risk of fatal injury due to exposure to extreme heat or cold in the vehicle



If people – particularly children – are exposed to extreme temperatures over an

extended period of time, there is a risk of serious or even fatal injury.

- ▶ Never leave anyone – particularly children – unattended in the vehicle.
- ▶ Never leave animals in the vehicle unattended.

Overview of suitable seats in the vehicle for installing a child restraint system

Securing systems for child restraint systems

Vehicle seat		
Left/right rear seat	<p>Preferred securing system:</p>  LATCH-type (ISOFIX) child seat securing system  Also secure Top Tether if present (→ page 55)	<p>Alternative securing system:</p> <ul style="list-style-type: none"> • Vehicle seat belt
Front passenger seat	<p>Securing system:</p> <ul style="list-style-type: none"> • Vehicle seat belt 	<p>Be sure to observe:</p> <ul style="list-style-type: none"> • If the front passenger seat is occupied, ensure, both before and during the journey, that the status of the front passenger front airbag is correct for the current situation (→ page 43). • Notes on automatic front passenger front airbag shutoff (→ page 41).

Vehicle seat

Center rear seat

Securing system:

- Vehicle seat belt



Also secure Top Tether if present
(→ page 55)

Activating/deactivating the seat belt's child special seat belt retractor

⚠ WARNING Risk of injury or death if a seat belt is unfastened while the vehicle is in motion

If the seat belt is released while the vehicle is in motion, the child restraint system is no longer correctly secured. The child seat safety feature is deactivated and the seat belt is drawn in a bit by the inertia reel.

It is therefore not possible to engage the seat belt again.

- ▶ Pull over and stop the vehicle safely as soon as possible, paying attention to road and traffic conditions.
- ▶ Activate the child seat safety feature again and correctly secure the child restraint system.

When enabled, the special seat belt retractor ensures that the seat belts of the front passenger seat and rear seats do not slacken once the child restraint system is secured.

The seat belts on the following seats are equipped with a special seat belt retractor:

- Front passenger seat
- Rear seats

- ▶ **To install a child restraint system:** when installing a child restraint system, always observe the manufacturer's installation and operating instructions as well as the information in this Operator's Manual.
- ▶ Pull the seat belt smoothly from the seat belt outlet.
- ▶ Engage the seat belt tongue in the seat belt buckle.
- ▶ **To activate the special seat belt retractor:** pull the seat belt out fully and let the inertia reel retract it again. When the special seat belt retractor is activated, you should hear a ratcheting sound.
- ▶ Push the child restraint system down until the seat belt sits tightly.

- ▶ **To deactivate the special seat belt retractor:** press the release button of the seat belt buckle.
- ▶ Hold the seat belt tongue and guide back to the seat belt outlet.

Installing the LATCH-type (ISOFIX) child restraint system on the rear seat

Installing the LATCH-type (ISOFIX) child restraint system on the rear seat

⚠ WARNING Risk of injury if the rear bench seat/rear seat and seat backrest are not engaged

If the rear bench seat/rear seat and seat backrest are not engaged they could fold forwards, e.g. when braking suddenly or in the event of an accident.

- If this is the case, the vehicle occupant would be forced into the seat belt by the rear bench seat/rear seat or by the seat backrest. The seat belt cannot protect as

intended and could result in additional injury.

- Objects or loads in the trunk/cargo compartment cannot be restrained by the seat backrest.
- ▶ Make sure that the seat backrest and the rear bench seat/rear seat are engaged before every trip.

Ensure that the rear seat backrest is engaged. To do so, pull forcefully on the seat backrest.

⚠ WARNING Risk of injury or death if the permissible gross mass of the child and child restraint system is exceeded

For LATCH-type (ISOFIX) child restraint systems in which the child is secured using the integrated seat belt in the child restraint system, the permissible gross mass of the child and child restraint system is 73 lb (33 kg).

If the child and the child restraint system together weigh more than 73 lb (33 kg), the LATCH-type (ISOFIX) child restraint system

with integrated seat belt does not offer sufficient protection. An excessive load may be placed on the LATCH-type (ISOFIX) child seat attachments and the child may not be restrained in the event of an accident, for example.

- ▶ If the child and the child restraint system together weigh more than 73 lb (33 kg), use only a LATCH-type (ISOFIX) child restraint system that secures the child with the vehicle seat belt.
- ▶ Also secure the child restraint system with the Top Tether belt, if available.

Always comply with the information about the mass of the child restraint system:

- in the manufacturer's installation and operating instructions for the child restraint system used
- on a label on the child restraint system, if present

Regularly check that the permissible gross mass of the child and child restraint system is still complied with.

When you are installing a child restraint system, observe the following:

- ✓ Always observe the correct use and the suitability of the seats for attaching a child restraint system.
- ✓ Always comply with the manufacturer's installation and operating instructions for the child restraint system used.
- ✓ Make sure that the child's feet do not touch the front seat. If necessary, move the front seat forward slightly.



When you are installing a LATCH-type (ISOFIX) child restraint system, observe the following:

- ✓ **When you are using a Group 0/0+ baby car seat and a Group 1 rearward-facing child restraint system on a rear seat:** adjust the front seat so that the seat does not touch the child restraint system.
- ✓ **When you are using a Group 1 forward-facing child restraint system:** remove the head restraint from the respective seat, if

possible. In addition, the seat backrest of the child restraint system must, as far as possible, lie flat against the backrest of the vehicle seat.

After the child restraint system has been removed, replace the head restraints again immediately and adjust them correctly.

- ✓ For certain child restraint systems in weight group 2 or 3, there may be restrictions in the maximum size setting, e.g. due to possible contact with the roof.
- ✓ The child restraint system must not be tensioned between the roof and the seat cushion and/or be installed facing the wrong direction. Where possible, adjust the seat cushion inclination accordingly.
- ✓ The child restraint system must not be put under strain by the head restraints. Adjust the head restraints accordingly.

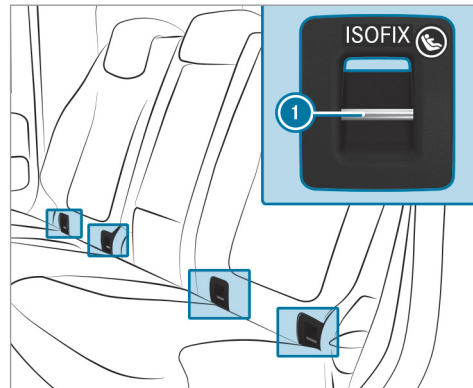

① LATCH-type (ISOFIX) mounting bracket

Before every trip, make sure that the LATCH-type (ISOFIX) child restraint system is engaged correctly in both mounting brackets in the vehicle.

! **NOTE** Be careful not to damage the seat belt for the center seat when installing the child restraint system

▶ Make sure that the seat belt is not trapped.

▶ Attach the LATCH-type (ISOFIX) child restraint system to both mounting brackets in the vehicle.

Securing Top Tether

! **WARNING** Risk of injury or death if the rear seat backrests are not locked after installing Top Tether belts

If the rear seat backrests are not locked, they could fold forwards in the event of an accident, braking or sudden changes of direction.

As a result, child restraint systems can no longer perform their intended protective function. Rear seat backrests that are not locked can also cause additional injuries, e.g. in the event of an accident.

▶ Always lock rear seat backrests after installing Top Tether belts.

▶ Set the rear seat backrests to the upright position.

Ensure that the rear seat backrest is engaged. To do so, pull forcefully on the seat backrest.



If the child restraint system is equipped with a Top Tether belt:

The risk of injury can be reduced by Top Tether. The Top Tether belt facilitates an additional connection between the child restraint system attached with LATCH-type (ISOFIX) and the vehicle.

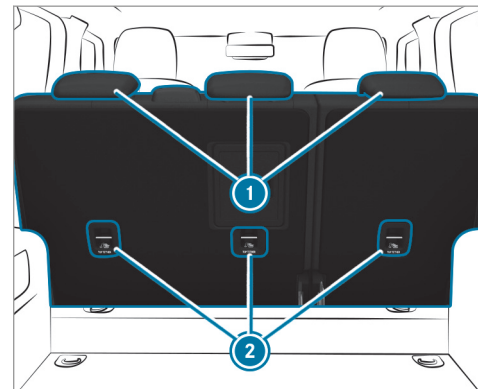

- ▶ Remove the cargo compartment cover and the load protection net (→ page 98).
- ▶ If necessary, move head restraint ① upwards (→ page 83).
- ▶ Install the LATCH-type (ISOFIX) child restraint system with Top Tether. Always comply with the child restraint system manufacturer's installation instructions when doing so.

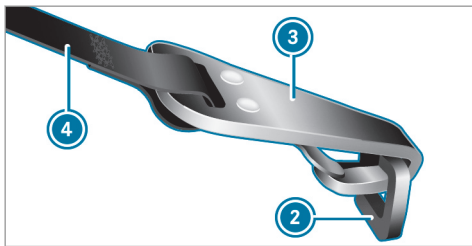

- ▶ Guide Top Tether belt ④ under head restraint ① between the two head restraint bars.
- ▶ Hook Top Tether hook ③ without twisting into Top Tether anchorage ②.
- ▶ Tension Top Tether belt ④. Always comply with the child restraint system manufacturer's installation instructions when doing so.
- ▶ If necessary, slide head restraint ① downwards (→ page 83). Make sure that you do not interfere with the correct routing of Top Tether belt ④.

Securing the child restraint system with the seat belt

Securing the child restraint system with the seat belt on the rear seat

⚠ WARNING Risk of injury if the rear bench seat/rear seat and seat backrest are not engaged

If the rear bench seat/rear seat and seat backrest are not engaged they could fold forwards, e.g. when braking suddenly or in the event of an accident.

- If this is the case, the vehicle occupant would be forced into the seat belt by the rear bench seat/rear seat or by the seat backrest. The seat belt cannot protect as intended and could result in additional injury.
- Objects or loads in the trunk/cargo compartment cannot be restrained by the seat backrest.

- ▶ Make sure that the seat backrest and the rear bench seat/rear seat are engaged before every trip.

Ensure that the rear seat backrest is engaged. To do so, pull forcefully on the seat backrest.

When installing a belt-secured child restraint system, observe the following:

- ☑ Always comply with the manufacturer's installation and operating instructions for the child restraint system used.
- ☑ **When using a category 0/0+ baby car seat and a category I rearward-facing child restraint system on a rear seat:** adjust the front seat so that the seat does not touch the child restraint system.
- ☑ **When using a category I forward-facing child restraint system:** remove the head restraint from the respective seat, if possible.

After removing the child restraint system, replace the head restraints again immediately and adjust them correctly.

- ✓ The backrest of the forward-facing child restraint system must, as far as possible, be resting on the seat backrest of the rear seat.
- ✓ For certain child restraint systems in weight category II or III, there may be restrictions in the maximum size setting, e.g. due to possible contact with the roof.
- ✓ The child restraint system must not be put under strain between the roof and the seat cushion and/or be installed facing the wrong direction. Where possible, adjust the seat cushion inclination accordingly.
- ✓ The child restraint system must not be put under strain by the head restraints. Adjust the head restraints accordingly.
- ✓ Make sure that the child's feet do not touch the front seat. If necessary, move the front seat forward slightly.

The seat belts on the following seats are equipped with a special seat belt retractor:

- Front passenger seat
- Rear seats

When enabled, the special seat belt retractor ensures that the seat belts of the front passenger seat and rear seats do not slacken once the child restraint system is secured (→ page 52).

- ▶ Install the child restraint system. The entire base of the child restraint system must always rest on the sitting surface of the rear seat.
- ▶ Always make sure that the shoulder belt strap is correctly routed from the seat belt outlet of the vehicle to the shoulder belt guide on the child restraint system. The shoulder belt strap must be routed forwards and downwards from the seat belt outlet.

Notes on rearward-facing and forward-facing child restraint systems on the front passenger seat

⚠ WARNING Risk of injury or death from using a rearward-facing child restraint system when the front passenger front airbag is enabled

If you secure a child in a rearward-facing child restraint system on the front passenger seat and the PASSENGER AIR BAG OFF indicator lamp is off, the front passenger airbag can deploy in the event of an accident.

The child could be struck by the airbag.

Always ensure that the front passenger airbag is deactivated. The PASSENGER AIR BAG OFF indicator lamp must be lit.

NEVER use a rearward-facing child restraint system on a seat protected by an ENABLED FRONT AIRBAG in front of it, DEATH or SERIOUS INJURY to the CHILD can occur.

Observe the specific instructions for the rearward-facing and forward-facing child restraint systems (→ page 58).

Warning notice on the front passenger sun visor

Always observe the status of the front passenger front airbag on the PASSENGER AIR BAG OFF indicator lamp:

- When using a rearward-facing child restraint system on the front passenger seat, the front passenger front airbag must always be disabled. This is only the case if the PASSENGER AIR BAG OFF indicator lamp is lit continuously (→ page 43).
- If the PASSENGER AIR BAG OFF indicator lamp is off, the front passenger front airbag is enabled. The front passenger front airbag may deploy during an accident.

Securing the child restraint system with the seat belt on the front passenger seat

When installing a belt-secured child restraint system on the front passenger seat, always observe the following:

- ✓ Observe the child restraint system manufacturer's installation and operating instructions.
- ✓ When using a forward-facing child restraint system in Group I: remove the head restraint from the respective seat, if possible.
When you remove the child restraint system, install the head restraint again immediately and adjust all the head restraints correctly.
- ✓ The backrest of the forward-facing child restraint system must lie as flat as possible against the backrest of the front passenger seat.
- ✓ For certain child restraint systems in weight group II or III, there may be restrictions in the maximum size setting, e.g. due to possible contact with the roof.

- ✓ The child restraint system must not be put under strain between the roof and the seat cushion and/or be installed facing the wrong direction. Adjust the seat backrest inclination accordingly.
- ✓ The child restraint system must not be put under strain by the head restraints. Adjust the head restraints accordingly.
- ✓ Never place objects under or behind the child restraint system, e.g. cushions.

The seat belt on the front passenger side is equipped with a special seatbelt retractor.

When activated, the special seatbelt retractor ensures that the seat belt does not slacken once the child restraint system is secured (→ page 52).

- ▶ Set the front passenger seat as far back as possible and move the seat into the highest position.
- ▶ Fully retract the seat cushion length adjustment.
- ▶ Adjust the seat cushion inclination so that the front edge of the seat cushion is in the

highest position and the rear edge of the seat cushion is in the lowest position.

- ▶ Set the seat backrest to an almost vertical position.
- ▶ Install the child restraint system. The entire base of the child restraint system must always rest on the seat cushion of the front passenger seat.
- ▶ Always make sure that the shoulder belt strap is correctly routed from the seat belt outlet of the vehicle to the shoulder belt guide on the child restraint system. The shoulder belt strap must be routed forwards and downwards from the seat belt outlet.
- ▶ If necessary, adjust the seat belt outlet and the front passenger seat accordingly.

Child safety locks

Activating/deactivating the child safety lock for the rear doors

⚠ WARNING Risk of accident and injury due to children and animals left unattended in the vehicle

If you leave children and animals unattended in the vehicle, they may be able to set the vehicle in motion, for example by:

- Releasing the parking brake.
- Shifting the automatic transmission out of park position **P**.
- Starting the engine.

In addition, they may operate vehicle equipment and become trapped.

- ▶ Never leave children and animals unattended in the vehicle.
- ▶ When leaving the vehicle, always take the SmartKey with you and lock the vehicle.

⚠ WARNING Risk of fatal injury due to exposure to extreme heat or cold in the vehicle

If people – particularly children – are exposed to extreme temperatures over an extended period of time, there is a risk of serious or even fatal injury.

- ▶ Never leave anyone – particularly children – unattended in the vehicle.
- ▶ Never leave animals in the vehicle unattended.

⚠ WARNING Risk of accident and injury due to children left unattended in the vehicle

When children are traveling in the vehicle, they could:

- open doors, thereby endangering other people or road users
- get out of the vehicle and be hit by traffic
- operate vehicle equipment and become trapped, for example

- ▶ When children are traveling in the vehicle, always activate the available child safety locks.
- ▶ Never leave children unattended in the vehicle.
- ▶ When leaving the vehicle, always take the key with you and lock the vehicle.

Child safety locks for the rear doors and the rear side windows are available. The child safety lock on the rear doors secures each door separately. The doors can no longer be opened from the inside.

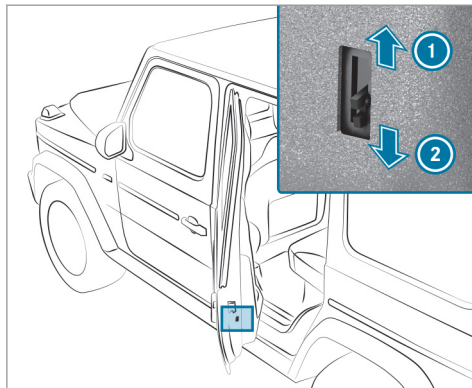

- ▶ Press the lever in direction ② (activate) or ① (deactivate).
- ▶ Make sure that the child safety locks are working properly.

Activating/deactivating the child safety lock for the rear side windows

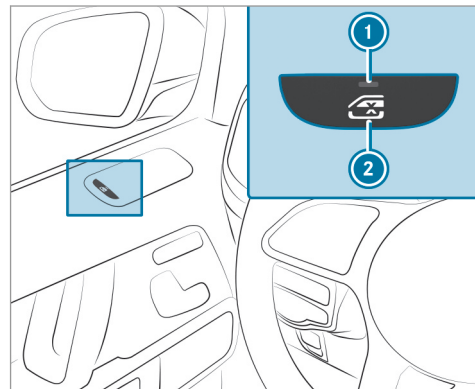

- ▶ **To activate/deactivate:** press button ②. The rear side window can be opened or closed in the following cases:
 - with indicator lamp ① lit: via the switch on the driver's door

- with indicator lamp ① off: via the switch on the corresponding rear door or driver's door

Notes on pets in the vehicle

⚠ WARNING Risk of accident and injury due to animals left unsecured or unattended in the vehicle

If you leave animals in the vehicle unattended or unsecured, they could possibly press down buttons or switches.

Thereby an animal may:

- activate vehicle equipment and become trapped, for example
- switch systems on or off and endanger other road users

Unsecured animals may be thrown around in the vehicle in the event of an accident or sudden steering and braking maneuver and injure vehicle occupants in the process.

- ▶ Never leave animals in the vehicle unattended.
- ▶ Always correctly secure animals while driving, for example using a suitable animal carrier.

SmartKey

Overview of SmartKey functions

⚠ WARNING Risk of accident and injury due to children left unattended in the vehicle

If children are left unattended in the vehicle, they could:

- Open doors, thereby endangering other persons or road users.
- Get out of the vehicle and be hit by oncoming traffic.
- Operate vehicle equipment and become trapped, for example.

In addition, children could also set the vehicle in motion, for example, by:

- Releasing the parking brake.
- Shifting the automatic transmission out of park position **P** or shifting manual transmission into neutral.
- Starting the engine

- ▶ When leaving the vehicle, always take the SmartKey with you and lock the vehicle.
- ▶ Never leave children and animals unattended in the vehicle.
- ▶ Keep the SmartKey out of reach of children.

! NOTE Damage to the key caused by magnetic fields

- ▶ Keep the key away from strong magnetic fields.



- ① Locks
- ② Battery check lamp
- ③ Unlocks
- ④ Panic alarm



ⓘ The SmartKey may vary from the one shown in the diagram, depending on the vehicle equipment.

The SmartKey locks and unlocks the following components:

- The doors
- The fuel filler flap
- The rear-end door

If the vehicle is not opened within approximately 40 seconds after unlocking, it locks again. Anti-theft protection is activated again.

Do not keep the SmartKey together with electronic devices or metal objects. This can affect the SmartKey's functionality.

- ❗ If battery check lamp ② does not light up after pressing the  or  button, the battery is discharged.

Replacing the SmartKey battery (→ page 64).

Activating/deactivating the acoustic locking verification signal

Multimedia system:

↳ Vehicle ▶  Vehicle Settings
 ▶▶ Acoustic Lock

- ▶ Activate or deactivate the function.

Activating/deactivating the panic alarm

Requirements:

- The ignition is switched off

- ❗ The panic alarm function is only available in certain countries.





- ▶ **To activate:** press button ① for approximately one second. A visual and audible alarm is triggered.
 - ▶ **To deactivate:** briefly press button ① again.
- or
- ▶ Press the start/stop button on the cockpit (the SmartKey is inside the vehicle).

Changing the unlocking settings

Possible unlocking functions of the SmartKey:

- Central unlocking

- Unlocking the driver's door and fuel filler flap

▶ **To switch between settings:** press the  and  buttons simultaneously for approximately six seconds until the battery check lamp flashes twice.

If the unlocking function for the driver's door and fuel filler flap has been selected:

- Pressing the  button a second time centrally unlocks the vehicle

Deactivating the SmartKey functions

If you do not use the vehicle or a SmartKey for an extended period of time, you can reduce the energy consumption of the respective SmartKey. To do so, deactivate the SmartKey functions.

- ▶ **To deactivate:** press the  button on the SmartKey twice in quick succession. The battery check lamp of the SmartKey flashes twice briefly and lights up once.
- ▶ **To activate:** press any button on the SmartKey.

- i** When the vehicle is started with the SmartKey in the stowage compartment of the center console, the SmartKey functions are automatically activated (→ page 127).

Removing/inserting the emergency key

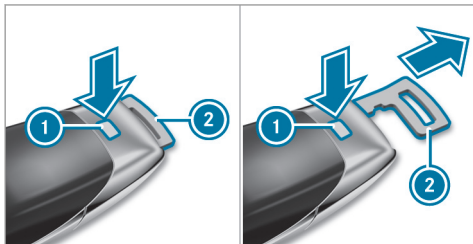

- ▶ **To remove:** press release button ①. Emergency key ② is pushed out slightly.
 - ▶ Pull out emergency key ② until it engages in the intermediate position.
- i** You can use the intermediate position of emergency key ② to attach the SmartKey to a key ring.

- ▶ Press release button ① again and fully remove emergency key ②.
- ▶ **To insert:** press release button ①.
- ▶ Insert emergency key ② to the intermediate position or fully until it engages.

Replacing the SmartKey battery

⚠ DANGER Serious damage to health caused by swallowing batteries

Batteries contain toxic and corrosive substances. Swallowing batteries may cause serious damage to health.

There is a risk of fatal injury.

- ▶ Keep batteries out of the reach of children.
- ▶ If batteries are swallowed, seek medical attention immediately.

🔥 ENVIRONMENTAL NOTE Environmental damage caused by improper disposal of batteries



Batteries contain pollutants. It is illegal to dispose of them with the household rubbish.



Dispose of batteries in an environmentally responsible manner. Take discharged batteries to a qualified specialist workshop or to a collection point for used batteries.

Requirements:

- You require a CR 2032 3 V cell battery.

Mercedes-Benz recommends that you have the battery replaced at a qualified specialist workshop.

- ▶ Remove the emergency key (→ page 64).

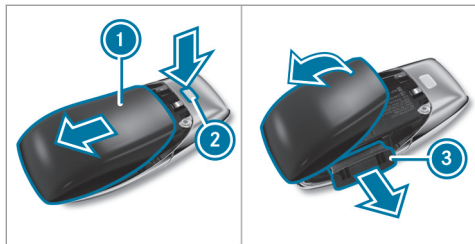

- ▶ Press release button ② down fully and slide cover ① in the direction of the arrow.
- ▶ Fold out cover ① in the direction of the arrow and remove.
- ▶ Remove battery compartment ③ and take out the discharged battery.
- ▶ Insert the new battery into battery compartment ③. Observe the positive pole marking in the battery compartment and on the battery when doing this.
- ▶ Push in battery compartment ③.
- ▶ Re-attach cover ① and push it until it engages.

Problems with the SmartKey

Problem	Possible causes/consequences and ▶ Solutions
<p>You can no longer lock or unlock the vehicle.</p>	<p>Possible causes are:</p> <ul style="list-style-type: none"> • The SmartKey battery is discharged or nearly discharged. • There is interference from a powerful radio signal source. • The SmartKey is defective. <ul style="list-style-type: none"> ▶ Check the battery using the battery check lamp and replace if necessary (→ page 64). ▶ Use the emergency key to lock or unlock (→ page 64).

Problem	Possible causes/consequences and ▶ Solutions
	<ul style="list-style-type: none">▶ Have the SmartKey checked at a qualified specialist workshop.
You have lost a SmartKey.	<ul style="list-style-type: none">▶ Have the SmartKey deactivated at a qualified specialist workshop.▶ If necessary, have the mechanical lock changed as well.

Doors

Unlocking and opening doors from the inside

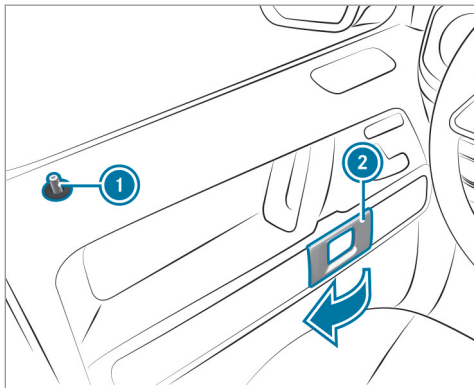

- ▶ **To unlock and open a front door:** pull door handle ②. Locking pin ① pops up when the door is unlocked.

- ▶ **To unlock a rear passenger compartment door:** pull the locking pin of the rear passenger compartment door upwards. The rear passenger compartment door is unlocked.
- ▶ **To open a rear passenger compartment door:** pull the rear passenger compartment door handle.

Centrally locking and unlocking the vehicle from the inside

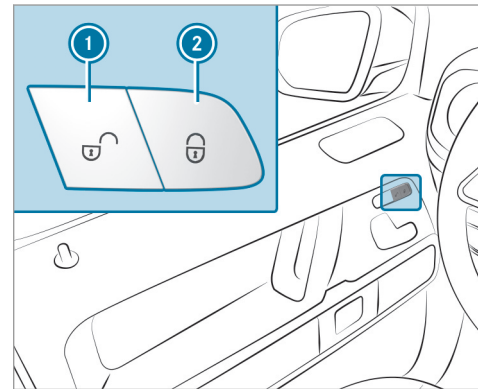

- ▶ **To unlock:** press button ①.
- ▶ **To lock:** press button ②.

This does not lock or unlock the fuel filler flap.

The vehicle is not unlocked:

- If you have locked the vehicle using the SmartKey.
- If the ignition is switched off for a long period while the vehicle is parked.

Locking/unlocking the driver's door with the emergency key

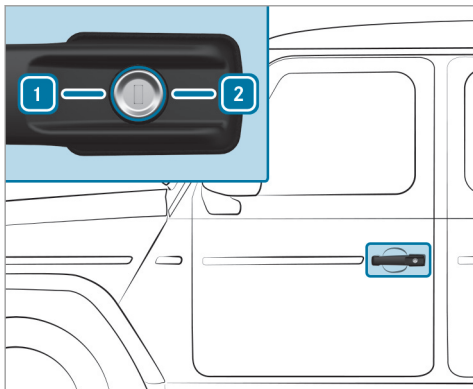

- ▶ Insert the emergency key into the lock of the driver's door as far as it will go.
- ▶ **To unlock:** turn the emergency key counter-clockwise as far as it will go to position **1**.
- ▶ **To lock:** turn the emergency key clockwise as far as it will go to position **2**.

Rear-end door

Opening and closing the rear-end door

⚠ DANGER Risk of poisoning from exhaust gases

Combustion engines emit poisonous exhaust gases, such as carbon monoxide. Exhaust gases can enter the vehicle interior if the rear-end door is open when the engine is running, especially if the vehicle is in motion.

- ▶ Always switch off the engine before opening the rear-end door.
- ▶ Never drive with the rear-end door open.

⚠ WARNING Risk of injury from unsecured items in the vehicle

If objects, luggage or loads are not secured or not secured sufficiently, they could slip, tip over or be thrown around and thereby hit vehicle occupants.

There is a risk of injury, particularly in the event of sudden braking or a sudden change in direction.



- ▶ Always stow objects in such a way that they cannot be thrown around.
- ▶ Before the journey, secure objects, luggage or loads against slipping or tipping over.

! NOTE Damage to the rear-end door when opening

The rear-end door swings out to the side when it is opened.

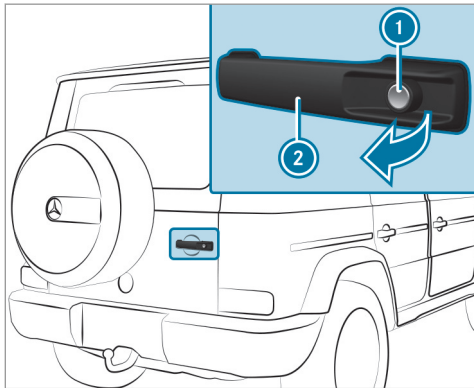
- ▶ Ensure that there is sufficient clearance.



- ▶ **To open:** press the  button on the SmartKey.
- ▶ Press release button **1** and pull door handle **2**.
- ▶ Open the rear-end door.
- ▶ **To close:** close the rear-end door.
- ▶ Press the  button on the SmartKey. The rear-end door is locked.

Side windows

Opening and closing the side windows

- ▶ **WARNING** Risk of entrapment when opening a side window

When opening a side window, parts of the body could be drawn in or become trapped between the side window and window frame.

- ▶ When opening, make sure that nobody is touching the side window.
- ▶ If someone is trapped, release the button immediately or pull it in order to close the side window again.

- ▶ **WARNING** Risk of becoming trapped when closing a side window

When closing a side window, body parts could be trapped in the closing area in the process.

- ▶ When closing, make sure that no body parts are in the closing area.

- ▶ If someone is trapped, release the button immediately or press the button in order to reopen the side window.

- ▶ **WARNING** Risk of becoming trapped when children operate the side windows

Children could become trapped if they operate the side windows, particularly when unattended.

- ▶ Activate the child safety lock for the rear side windows.
- ▶ When leaving the vehicle, always take the SmartKey with you and lock the vehicle.
- ▶ Never leave children unattended in the vehicle.

Requirements:

- The power supply or the ignition is switched on.

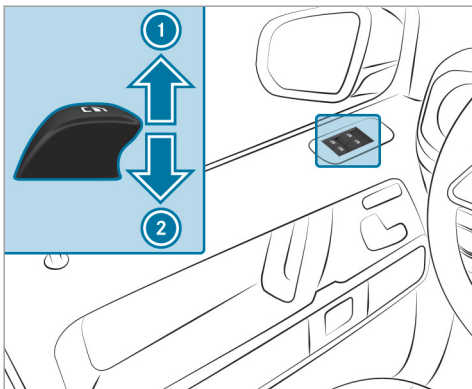

① Closes

② Opens

The buttons on the driver's door take precedence.

▶ **To start automatic operation:** press the  button beyond the point of resistance or pull and release it.

▶ **To interrupt automatic operation:** press or pull the  button again.

When the vehicle is switched off, the side windows can continue being operated.

The function is available for around five minutes or until a front door is opened.

Automatic reversing function of the side windows

If an object blocks a side window during the closing process, the side window opens again automatically. The automatic reversing function is only an aid and is not a substitute for your attentiveness.

▶ When closing, make sure that no body parts are in the closing area.

⚠ WARNING Risk of becoming trapped despite there being reversing protection on the side window

The reversing function does not react:

- To soft, light and thin objects, e.g. fingers
- During resetting

This means that the reverse function cannot prevent someone from becoming trapped in these situations.

- ▶ When closing, make sure that no body parts are in the closing area.
- ▶ If someone becomes trapped, press the  button to open the side window again.

Convenience opening (ventilating the vehicle before starting a journey)

⚠ WARNING Risk of entrapment when opening a side window

When opening a side window, parts of the body could be drawn in or become trapped between the side window and window frame.

- ▶ When opening, make sure that nobody is touching the side window.
- ▶ Release the button immediately if somebody becomes trapped.

- ▶ Press and hold the  button on the SmartKey.

The following functions are performed:

- The vehicle is unlocked.
- The side windows are opened.
- The sliding sunroof is opened.
- The seat ventilation of the driver's seat is switched on.

- ▶ **To interrupt convenience opening:** release the  button.

Convenience closing (closing the vehicle from outside)

 **WARNING** Risk of entrapment caused by inadvertent convenience closing

When the convenience closing feature is operating, parts of the body could become trapped in the closing area of the side window and the sliding sunroof.

- ▶ Observe the complete closing procedure when using convenience closing.

- ▶ When closing, make sure that no body parts are in the closing area.

- ▶ Press and hold the  button on the SmartKey.

The following functions are performed:

- The vehicle is locked.
- The side windows are closed.
- The sliding sunroof is closed.

- ▶ **To interrupt convenience closing:** release the  button.

Problems with the side windows

Problem	Possible causes/consequences and ▶ Solutions
<p>A side window cannot be closed and you cannot see the cause.</p>	<ul style="list-style-type: none"> ▶ Check to see whether any objects are in the window guide. <p> WARNING Risk of becoming trapped or fatally injured if reversing protection is not activated</p> <p>If you close a side window again immediately after it has been blocked or reset, the side window closes with increased or maximum force. The reversing feature is then not active.</p> <p>Parts of the body could become trapped in the closing area in the process.</p>

Problem	Possible causes/consequences and ► Solutions
	<ul style="list-style-type: none">► Make sure that no parts of the body are in the closing area.► To stop the closing process, release the button or press the button again to reopen the side window. <p>If a side window is obstructed during closing and reopens again slightly:</p> <ul style="list-style-type: none">► Immediately after the window is blocked, pull the corresponding switch again until the side window has closed, and hold the switch for an additional second. The side window will be closed with increased force. <p>If a side window is obstructed again during closing and reopens again slightly:</p> <ul style="list-style-type: none">► Repeat the previous step. The side window is closed without the automatic reversing function.
The side windows cannot be opened or closed using the convenience opening feature.	<p>The SmartKey battery is discharged or nearly discharged.</p> <ul style="list-style-type: none">► Check the battery using the battery check lamp and replace if necessary (→ page 64).

Sliding sunroof

Opening and closing the sliding sunroof

⚠ WARNING Risk of becoming trapped while opening and closing the sliding sunroof

During opening and closing, parts of the body could get caught in the sweep of the sliding sunroof.

- ▶ When opening or closing, make sure that no body parts are in the sweep.
- ▶ Release the button immediately if somebody becomes trapped.

or

- ▶ Press the button in any direction during the automatic opening/closing process. The opening/closing process is stopped.

⚠ WARNING Risk of becoming trapped if the sliding sunroof is operated by children

Children operating the sliding sunroof could get caught in the moving parts, particularly if unattended.

- ▶ Never leave children unattended in the vehicle.
- ▶ When leaving the vehicle, always take the key with you and lock the vehicle.

! NOTE Malfunction caused by snow and ice

Snow and ice may lead to a malfunction of the sliding sunroof.

- ▶ Only open the sliding sunroof if it is free of snow and ice.

! NOTE Damage caused by protruding objects

Objects that protrude from the sliding sunroof may damage the sealing strips.

- ▶ Do not allow anything to protrude from the sliding sunroof.

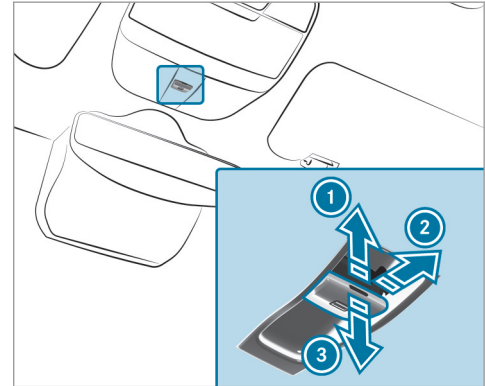

- ① To raise
- ② To open
- ③ To close/lower

▶ **To start automatic operation:** press the  button beyond the point of resistance or pull and release it.

▶ **To interrupt automatic operation:** briefly press the  button in any direction. The opening/closing process will be stopped.

Vehicles without a panoramic sliding sunroof: The automatic opening and raising feature is available only when the sliding sunroof is closed.

Automatic reversing function of the sliding sunroof

If there is an object obstructing the sliding sunroof during the closing process, the sliding sun-

roof will open again automatically. The automatic reversing function is only an aid and is not a substitute for your attentiveness.

▶ When closing, make sure that no body parts are in the closing area.

⚠ WARNING Risk of entrapment even with the reversing function active

The reversing feature does not react in particular:

- To soft, light and thin objects, e.g. fingers
- Over the last $\frac{1}{6}$ in (4 mm) of the closing path

- During resetting

This means that the reverse function cannot prevent someone from becoming trapped in these situations.

- ▶ When closing, make sure that no body parts are in the closing area.
- ▶ Release the button immediately if somebody becomes trapped.

or

- ▶ Briefly press the button in any direction during automatic operation. The closing process is stopped.

Problems with the sliding sunroof

Problem

The sliding sunroof cannot be closed and you cannot see the cause.

Possible causes/consequences and ► Solutions

⚠ WARNING Risk of becoming trapped or fatal injury by closing the sliding sunroof again

If you close the sliding sunroof again immediately after it has been blocked or reset, the sliding sunroof closes with increased force.

Parts of the body could become trapped in the closing area in the process.

- Make sure that no parts of the body are in the closing area.
- Release the button immediately if somebody becomes trapped.

or



- Press the button in any direction during the automatic closing process.
The closing process is stopped.

If the sliding sunroof is obstructed during closing and reopens again slightly:

- Immediately after automatic reversing, pull and hold the  button down again to the point of resistance until the sliding sunroof is closed.
The sliding sunroof will be closed with increased force.

If the sliding sunroof is obstructed again and reopens again slightly:

- Repeat the previous step.
The sliding sunroof will be closed again with increased force.

Problem	Possible causes/consequences and ► Solutions
<p>Vehicles without a panoramic sliding sunroof: The sliding sunroof does not operate smoothly.</p>	<ul style="list-style-type: none"> ► Push the  button up to the point of resistance until the sliding sunroof is fully open. ► Press the  button for another second. ► Close the sliding sunroof.

Anti-theft protection

Function of the immobilizer

The immobilizer prevents your vehicle from being started without the correct SmartKey.

The immobilizer is automatically activated when the ignition is switched off and deactivated when the ignition is switched on.

When leaving the vehicle, always take the SmartKey with you and lock the vehicle. Anyone can start the engine if a valid SmartKey has been left inside the vehicle.

i In the event the engine cannot be started (yet the vehicle's starter battery is charged), the system is not operational. Contact an authorized Mercedes-Benz Center or call

1-800-FOR-MERCEdes (in the USA) or
1-800-387-0100 (in Canada).

ATA (anti-theft alarm system)

Function of the ATA system

If the ATA system is armed, a visual and audible alarm is triggered in the following situations:

- when a door is opened
- when the rear-end door is opened
- when the hood is opened
- when the interior motion sensor is triggered (→ page 78)
- when the tow-away alarm is triggered (→ page 77)

The ATA system is armed automatically after approximately ten seconds in the following situations:

- after locking the vehicle with the SmartKey

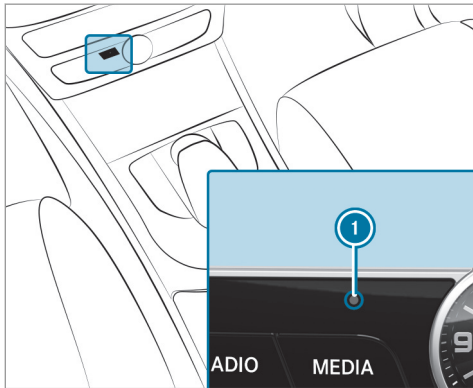



Indicator lamp ① flashes when the ATA system is armed.

The ATA system is deactivated automatically in the following situations:

- after unlocking the vehicle with the SmartKey
- after pressing the start/stop button with the SmartKey in the stowage compartment (→ page 127)

ⓘ When the Mercedes-Benz emergency call system is active and the alarm stays on for more than 30 seconds, a message is automatically sent to the Customer Assistance Center (→ page 293).

Deactivating the ATA

- ▶ Press the  or  button on the SmartKey.
- or
- ▶ Press the start/stop button with the SmartKey in the stowage compartment (→ page 127)

Function of the tow-away alarm

An audible and visual alarm is triggered if your vehicle's angle of inclination is altered while the tow-away alarm is armed.

The tow-away alarm is automatically armed after about 60 seconds:

- After locking the vehicle with the SmartKey

The tow-away alarm is only armed when the following components are closed:

- The doors
- The rear-end door

The tow-away alarm is automatically deactivated:

- After pressing the  button on the SmartKey
- After pressing the start/stop button with the SmartKey in the stowage compartment (→ page 127)

Arming/disarming the tow-away alarm

Multimedia system:

➔ Vehicle ➔  Vehicle Settings
 ➔ Tow-away Protection

▶ Activate or deactivate the function.

The tow-away alarm is armed again in the following cases:

- The vehicle is unlocked again.
- A door is opened.

- The vehicle is locked again.

Function of the interior motion sensor

When the interior motion sensor is activated, a visual and audible alarm is triggered if movement is detected in the vehicle interior.

The interior motion sensor is armed automatically after approximately ten seconds:

- after locking the vehicle with the SmartKey

The interior motion sensor is only activated when the following components are closed:

- doors
- The rear-end door

The interior motion sensor is automatically deactivated:

- after pressing the  button on the SmartKey
- after pressing the start/stop button with the SmartKey in the stowage compartment (→ page 127)

The following situations can lead to a false alarm:

- moving objects such as mascots in the vehicle interior
- when the side window is open
- when the sliding sunroof is open

Activating/deactivating the interior motion sensor

Multimedia system:

↳ Vehicle »  Vehicle Settings
» Interior Motion Sensor

▶ Activate or deactivate the function.

The interior motion sensor is activated again in the following cases:

- The vehicle is unlocked again.
- A door is opened.
- The vehicle is locked again.

Notes on the correct driver's seat position

⚠ WARNING Risk of injury from adjusting the vehicle settings while the vehicle is in motion

You could lose control of the vehicle in the following situations:

- if you adjust the driver's seat, the head restraint, the steering wheel or the mirror while the vehicle is in motion
- if you fasten your seat belt while the vehicle is in motion

▶ Before starting the engine: adjust the driver's seat, the head restraint, the steering wheel or the mirror and fasten your seat belt.

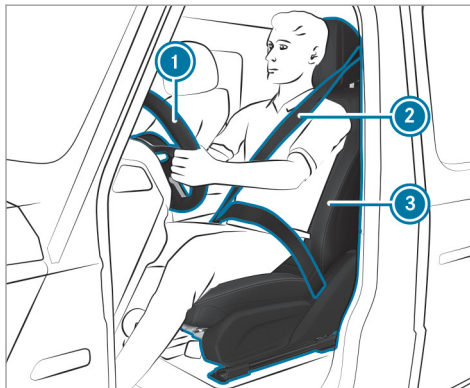

Ensure the following when adjusting the steering wheel ①, seat belt ② and driver's seat ③:

- you are as far away from the driver's airbag as possible
- you are sitting in an upright position
- your thighs are slightly supported by the seat cushion

- your legs are not fully extended and you can depress the pedals properly
- the back of your head is supported at eye level by the center of the head restraint
- you can hold the steering wheel with your arms slightly bent
- you can move your legs freely
- you can see all the displays on the instrument cluster clearly
- you have a good overview of the traffic conditions
- your seat belt is pulled snugly against your body and is routed across the center of your shoulder and across your hips in the pelvic area

Seats

Adjusting the front seat electrically

⚠ WARNING Risk of becoming trapped if the seats are adjusted by children

Children could become trapped if they adjust the seats, particularly when unattended.

- ▶ When leaving the vehicle, always take the SmartKey with you and lock the vehicle.
- ▶ Never leave children unattended in the vehicle.

The seats can be adjusted when the ignition is switched off.

⚠ WARNING Risk of becoming trapped when adjusting the seats

When you adjust a seat, you or other vehicle occupants could become trapped, e.g. on the seat guide rail.

- ▶ When adjusting a seat, make sure that no one has any body parts in the sweep of the seat.

Observe the safety notes on "Airbags" and "Children in the vehicle".

⚠ WARNING Risk of injury from adjusting the vehicle settings while the vehicle is in motion

You could lose control of the vehicle in the following situations:

- if you adjust the driver's seat, the head restraint, the steering wheel or the mirror while the vehicle is in motion
 - if you fasten your seat belt while the vehicle is in motion
- ▶ Before starting the engine: adjust the driver's seat, the head restraint, the steering wheel or the mirror and fasten your seat belt.

⚠ WARNING Risk of becoming trapped if the seat height is adjusted carelessly

If you adjust the seat height carelessly, you or other vehicle occupants could be trapped and thereby injured.

Children in particular could accidentally press the electrical seat adjustment buttons and become trapped.

- ▶ While moving the seats, make sure that hands or other body parts do not get under the lever assembly of the seat adjustment system.

⚠ WARNING Risk of injury due to head restraints which are not installed or are adjusted incorrectly

If head restraints are not installed or are adjusted incorrectly, the head restraints cannot provide protection as intended.

There is an increased risk of injury in the head and neck area, e.g. in the event of an accident or when braking.

- ▶ Always drive with the head restraints installed.
- ▶ Before driving off, make sure for every vehicle occupant that the center of the head restraint supports the back of the head at about eye level.

Do not interchange the head restraints of the front and rear seats. Otherwise, you will not be able to adjust the height and angle of the head restraints correctly.

Adjust the head restraint fore-and-aft position so that it is as close as possible to the back of your head.

⚠ WARNING Risk of injury or death due to incorrect seat position

The seat belt does not offer the intended level of protection if you have not moved the seat backrest to an almost vertical position.

When braking or in the event of an accident, you could slide underneath the seat belt and sustain abdominal or neck injuries, for example.

- ▶ Adjust the seat properly before beginning your journey.
- ▶ Always ensure that the seat backrest is in an almost vertical position and that the shoulder section of your seat belt is routed across the center of your shoulder.

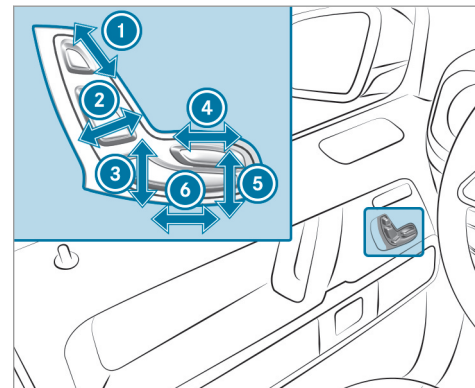

- ① Head restraint height
- ② Seat backrest inclination
- ③ Seat height
- ④ Seat cushion length
- ⑤ Seat cushion inclination
- ⑥ Seat fore-and-aft position

▶ Save the settings with the memory function (→ page 89).

Head restraints

Adjusting the front seat luxury head restraints mechanically

⚠ WARNING Risk of injury from adjusting the vehicle settings while the vehicle is in motion

You could lose control of the vehicle in the following situations:

- if you adjust the driver's seat, the head restraint, the steering wheel or the mirror while the vehicle is in motion
 - if you fasten your seat belt while the vehicle is in motion
- ▶ Before starting the engine: adjust the driver's seat, the head restraint, the steering wheel or the mirror and fasten your seat belt.

⚠ WARNING Risk of injury due to incorrectly adjusted head restraints

If head restraints are not adjusted correctly, the head restraints cannot provide protection as intended.

There is an increased risk of injury in the head and neck area, e.g. in the event of an accident or when braking.

- ▶ Before driving off, make sure for every vehicle occupant that the center of the head restraint supports the back of the head at about eye level.

Adjust the head restraint fore-and-aft position so that it is as close as possible to the back of your head.

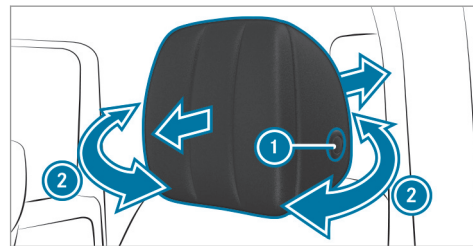

- ▶ **To adjust the side bolsters of the head restraint:** pull or push right or left-hand side bolster ②.
- ▶ **To move forwards:** pull the head restraint forwards.
- ▶ **To move backwards:** press release knob ① and push the head restraint backwards.

Adjusting the head restraints of the rear seats mechanically

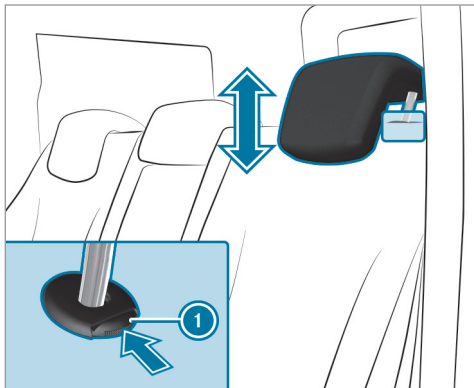

- ▶ **To raise:** pull the head restraint up.
- ▶ **To lower:** press release knob ① in the direction of the arrow and push the head restraint down.

Adjusting the angle of the rear head restraints

You can adjust only the two external head restraints.

- ▶ Pull or push the bottom edge of the head restraint forwards or backwards until the desired position has been reached.

Installing/removing the rear seat head restraints

Removal

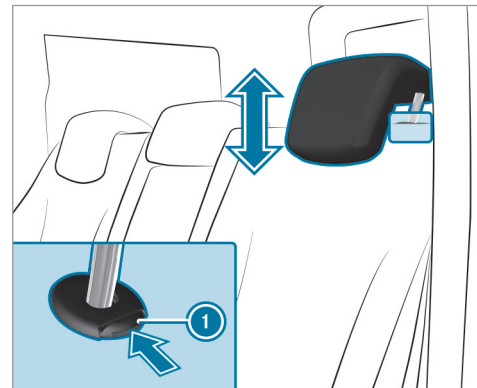

- ▶ Release the rear seat backrest and fold it slightly forwards (→ page 95).
- ▶ Pull the head restraint upwards as far as it will go.

- ▶ Push release knob  in the direction of the arrow and pull out the head restraint.

Installing

- ▶ Insert the head restraint such that the notches on the bar are on the left when viewed in the direction of travel.
- ▶ Push the head restraint down until you hear it engage in position.
- ▶ Fold the rear seat backrest back until it engages.

Configuring the seat settings

Multimedia system:

 [Vehicle](#)   [Seats](#)

- ▶ Select [Driver's Seat](#) or [Passenger Seat](#).

Adjusting the backrest side bolsters

- ▶ Select [Side Bolsters](#).
- ▶ Adjust the air cushions.

Adjusting the seat contour in the lumbar region of the seat backrest (lumbar)

- ▶ Select [Lumbar](#).
- ▶ Adjust the air cushions.

Memory function

- ▶ Save the seat settings with the memory function (→ page 89).

Setting automatic adjustment of the lateral support (active multicontour seat)

Multimedia system:

 [Vehicle](#)   [Seats](#)

With this function, the lateral support of the active multicontour seat is automatically adjusted to the driving and cornering dynamics of the vehicle.

- ▶ Select [Driver's Seat](#) or [Passenger Seat](#).
- ▶ Select [Dynamic Seat](#).
- ▶ **Select setting:** [Off](#), [Level 1](#) or [Level 2](#).

Overview of massage and workout programs

Massage programs

The following programs can be selected:

- [Hot Relaxing Back](#)
- [Hot Relaxing Shoulder](#)
- [Activating Massage](#)
- [Classic Massage](#)
- [Wave Massage](#)
- [Mobilizing Massage](#)

Active Workout

The [Act. Workout Back](#) program requires your active cooperation. Alternating between tensing and releasing helps to improve blood flow to your muscles. Press against a pressure point as soon as you feel it.

Selecting the massage program for the front seats

Multimedia system:

→ Vehicle →  Seats

- ▶ Select **Driver's Seat** or **Passenger Seat**.
- ▶ Select **Massage**.
- ▶ Select a massage program.
The massage program runs for approximately 8 to 18 minutes, depending on the setting.
- ▶ To set the massage intensity: switch **High Intensity** on or off .

Resetting the seat and massage settings

Multimedia system:

→ Vehicle →  Seats → Reset

- ▶ Select **Yes** or **No**.
- ① Only the currently selected seat is reset.

Switching the seat heating on/off

⚠ WARNING Risk of burns due to repeatedly switching on the seat heating

Repeatedly switching on the seat heating can cause the seat cushion and seat backrest padding to become very hot.

The health of persons with limited temperature sensitivity or a limited ability to react to high temperatures may be affected or they may even suffer burn-like injuries.

- ▶ Do not repeatedly switch on the seat heating.

To protect against overheating, the seat heating may be temporarily deactivated after it is switched on repeatedly.

! NOTE Damage to the seats caused by objects or documents when the seat heater is switched on

When the seat heater is switched on, overheating can occur due to objects or docu-

ments placed on the seats e.g. seat cushions or child seats. This could cause damage to the seat surface.

- ▶ Make sure that no objects or documents are on the seats when the seat heater is switched on.

Requirements:

- The power supply is switched on

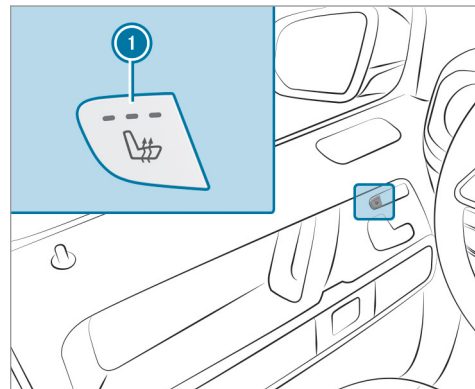

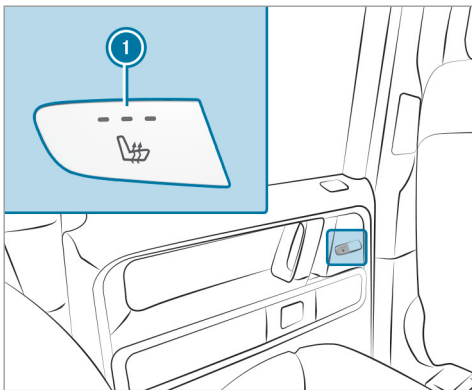

- ▶ **To switch on/increase the level:** press button ① repeatedly until the desired heating level is set. Depending on the heating level, up to three indicator lamps light up.

- ▶ **To switch off/reduce the level:** press button ① repeatedly until the desired heating level is set. If all indicator lamps are off, the seat heating is switched off.

- ⓘ The seat heating automatically switches down from the three heating levels after 8, 10 and 35 minutes until the seat heating is switched off.

Switching the seat ventilation on/off

Requirements:

- The power supply is switched on

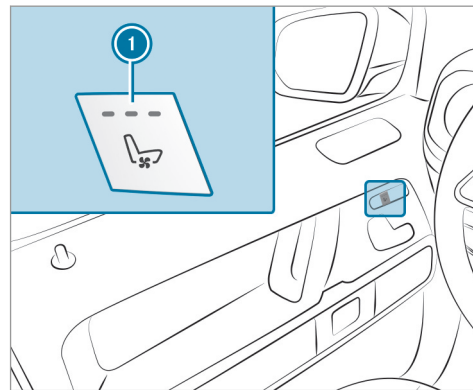

- ▶ **To switch on/increase the level:** press button ① repeatedly until the desired ventilation level is set. Depending on the ventilation level, up to three indicator lamps light up.

- ▶ **To switch off/reduce the level:** press button ① repeatedly until the desired ventilation level is set.
If all indicator lamps are off, the seat ventilation is switched off.

Steering wheel

Adjusting the steering wheel electrically

The steering wheel can be adjusted when the ignition is switched off.

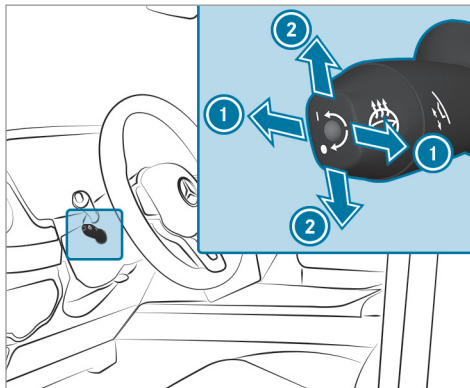

- ① Adjusts the distance to the steering wheel
- ② Adjusts the height

▶ Save the settings with the memory function (→ page 89).

- ⓘ If the driver's door is open, the steering wheel can be adjusted for up to 30 minutes after the ignition has been switched off.

Switching the steering wheel heater on or off

Requirements:

- The ignition is switched on.

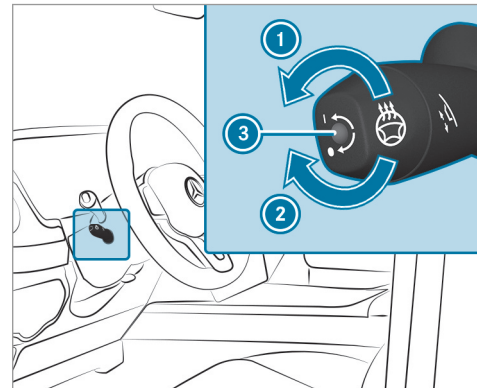

- ▶ Turn the lever in the direction of arrow ① or ②.
If indicator lamp ③ lights up, the steering wheel heater is switched on.

When you switch the ignition off, the steering wheel heater switches off.

Easy entry and exit feature

Using the easy entry and exit feature

⚠ WARNING Risk of accident when driving off while adjusting the easy exit feature

- If you drive off while the easy entry and exit feature is making adjustments, you could lose control of the vehicle.

- ▶ Always wait until the adjustment process is complete before driving off.

⚠ WARNING Risk of becoming trapped while adjusting the easy entry and exit feature

When the easy entry and exit feature adjusts the steering wheel and the driver's seat, you and other vehicle occupants – particularly children – could become trapped.

- ▶ During adjustment of the easy entry and exit feature, make sure that no one

has any body parts in the sweep of the seat or the steering wheel.

- ▶ If somebody becomes trapped, press a memory function position button.

or

- ▶ Press the memory function button

or

- ▶ Move the switch for adjusting the steering wheel in the opposite direction to the steering wheel's direction of movement.
The adjustment process is stopped.

⚠ WARNING Risk of becoming trapped during activation of the easy entry and exit feature by children

If children activate the easy entry and exit feature, they can become trapped, particularly when unattended.

- ▶ Never leave children unattended in the vehicle.

- ▶ When leaving the vehicle, always take the SmartKey with you and lock the vehicle.

Vehicles with memory function: You can stop the adjustment process by pressing one of the memory function position buttons.

If the easy entry and exit feature is active, the steering wheel will move upwards or towards the dashboard in the following situations:

- you switch the ignition off
 - you open the driver's door when the ignition is switched on
- ⓘ The steering wheel moves upwards only if it has not already reached the steering limitation.

The steering wheel moves back to the last drive position in the following cases:

- you switch the ignition on when the driver's door is closed
- you close the driver's door when the ignition is switched on

The last drive position will be stored when:

- you switch the ignition off
- you save the steering column setting with the memory function.

If you press one of the memory function position buttons, the adjustment process is stopped.

Setting the easy entry and exit feature

Multimedia system:

↳ Vehicle ▶  Vehicle Settings
 ▶▶ Easy Entry/Exit

▶ Activate or deactivate the function.

Operating the memory function

⚠ WARNING Risk of an accident if the memory function is used while driving

If you use the memory function on the driver's side while driving, you could lose control of the vehicle as a result of the adjustments being made.

▶ Only use the memory function on the driver's side when the vehicle is stationary.

⚠ WARNING Risk of entrapment when setting the seat with the memory function

When the memory function adjusts the seat or steering wheel, you and other vehicle occupants – particularly children – could become trapped.

- ▶ During the setting procedure of the memory function, ensure that no body parts are in the sweep of the seat or the steering wheel.
- ▶ If somebody becomes trapped, immediately release the memory function position button.
The adjustment process is stopped.

⚠ WARNING Risk of entrapment if the memory function is activated by children

Children could become trapped if they activate the memory function, particularly when unattended.

- ▶ Never leave children unattended in the vehicle.
- ▶ When leaving the vehicle, always take the key with you and lock the vehicle.

The memory function can be used when the ignition is switched off.

Storing

Seat adjustments for up to three people can be stored and called up using the memory function.

The following systems can be selected:

- Seat, backrest and head restraint
- Steering wheel
- Outside mirrors

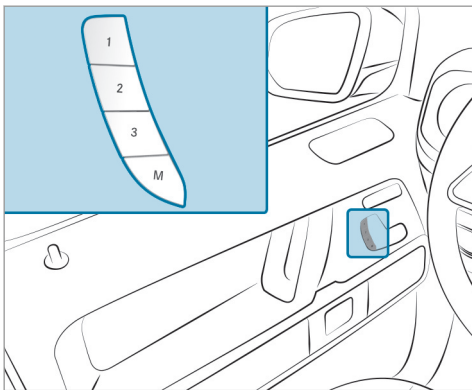

- ▶ Set the seat, the steering wheel and the outside mirrors to the desired position.
- ▶ Press memory button M together with one of preset position buttons 1, 2 or 3. An acoustic signal sounds. The settings are stored.
- ▶ **To call up:** press and hold the relevant preset position button 1, 2 or 3 until the front

seat, steering wheel and outside mirrors are in the stored position.

Stowage areas

Notes on loading the vehicle

⚠ DANGER Risk of poisoning from exhaust gases

Combustion engines emit poisonous exhaust gases, such as carbon monoxide. Exhaust gases can enter the vehicle interior if the rear-end door is open when the engine is running, especially if the vehicle is in motion.

- ▶ Always switch off the engine before opening the rear-end door.
- ▶ Never drive with the rear-end door open.

⚠ WARNING Risk of injury from unsecured items in the vehicle

If objects, luggage or loads are not secured or not secured sufficiently, they could slip,

tip over or be thrown around and thereby hit vehicle occupants.

There is a risk of injury, particularly in the event of sudden braking or a sudden change in direction.

- ▶ Always stow objects in such a way that they cannot be thrown around.
- ▶ Before the journey, secure objects, luggage or loads against slipping or tipping over.

⚠ WARNING Risk of injury due to objects being stowed incorrectly

If you do not adequately stow objects in the vehicle interior, they could slip or be tossed around and thereby strike vehicle occupants. In addition, cup holders, open stowage spaces and mobile phone brackets cannot always restrain the objects they contain in the event of an accident.

There is a risk of injury, particularly in the event of sudden braking or a sudden change in direction.

- ▶ Always stow objects in such a way that they cannot be tossed about in these or similar situations.
- ▶ Always make sure that objects do not project from stowage spaces, parcel nets or stowage nets.
- ▶ Close the lockable stowage spaces before starting a journey.
- ▶ Always stow and secure objects that are heavy, hard, pointed, sharp-edged, fragile or too large in the trunk.

⚠ WARNING Risk of burning from the tailpipe or tailpipe trim

The tailpipe and tailpipe trim can become very hot. If you come into contact with these car parts, you could burn yourself.

- ▶ Always be particularly careful when in the vicinity of the tailpipe and tailpipe trims and supervise children very closely when in this area.
- ▶ Before any contact, allow the car parts to cool down.

Driving, braking and steering characteristics change depending on:

- Type of load
- Weight
- Center of gravity of the load.

The gross vehicle weight (GVW) is the vehicle weight including fuel, vehicle tool kit, spare wheel, accessories installed, vehicle occupants and luggage/load.

Do not exceed the maximum permissible payload weight or permissible gross mass (GVWR) for your vehicle. The maximum permissible payload weight and GVWR are given on the vehicle identification plate found on the driver's door B-pillar.

Furthermore, the load must be distributed in such a way that the weight on each axle never exceeds the maximum gross axle weight rating (GAWR) for the front and rear axles. The relevant GVWR and GAWR information can be found on the vehicle identification plate on the driver's side B-pillar.

Bear the following in mind when loading and transporting loads:

- never exceed the permissible gross mass or the gross axle weight rating for the vehicle (including occupants). The values are specified on the vehicle identification plate on the vehicle's B-pillar.
- position heavy loads as far forwards as possible and as low down in the cargo compartment as possible.
- if possible, always transport loads in the cargo compartment. Only use the cargo compartment enlargement if the load does not fit in the cargo compartment.
- always place the load against the backrests of the front seats or rear seats.
- secure the load using the tie-down eyes and distribute the load evenly.
- use tie-down eyes and fastening components that are suitable for the weight and size of the load.

If the rear bench seat is not occupied:

- insert the seat belts into seat belt buckles of the opposite seat belt in a diagonal pattern.
- secure the load with sufficiently tear-resistant and wear-resistant tie downs.
- pad sharp edges for protection.

Stowage spaces in the vehicle interior

Overview of the front stowage compartments

⚠ WARNING Risk of injury due to objects being stowed incorrectly

If you do not adequately stow objects in the vehicle interior, they could slip or be tossed around and thereby strike vehicle occupants. In addition, cup holders, open stowage spaces and mobile phone brackets cannot always restrain the objects they contain in the event of an accident.

There is a risk of injury, particularly in the event of sudden braking or a sudden change in direction.

- ▶ Always stow objects in such a way that they cannot be tossed about in these or similar situations.
- ▶ Always make sure that objects do not project from stowage spaces, parcel nets or stowage nets.
- ▶ Close the lockable stowage spaces before starting a journey.
- ▶ Always stow and secure objects that are heavy, hard, pointed, sharp-edged, fragile or too large in the trunk.

Observe the notes on loading the vehicle.

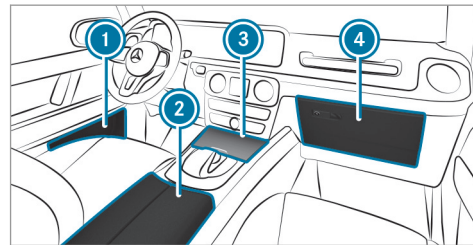

- ① Stowage compartment in the doors
- ② Stowage/telephone compartment in the armrest with multimedia and USB ports as well as stowage space, e.g. for an MP3 player
- ③ Stowage compartment in the front center console
- ④ Glove box

Locking and unlocking the glove box

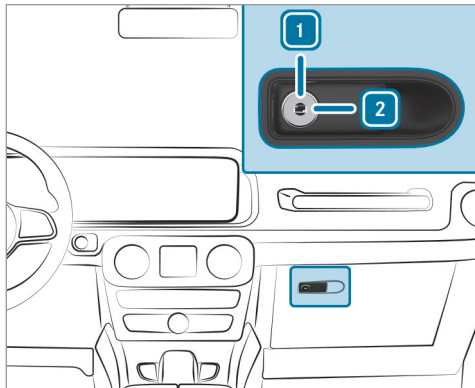

- ▶ Turn the emergency key a quarter turn clockwise **2** (to lock) or counter-clockwise **1** (to unlock).

Opening the eyeglasses compartment

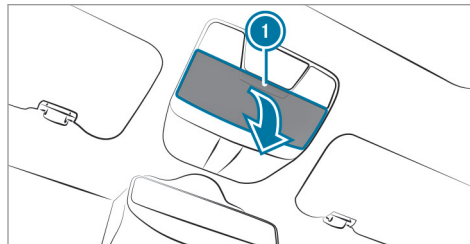

- ▶ Press button **1**.

Opening the through-loading feature in the rear passenger compartment

⚠ WARNING Risk of injury from unsecured items in the vehicle

If objects, luggage or loads are not secured or not secured sufficiently, they could slip, tip over or be thrown around and thereby hit vehicle occupants.

There is a risk of injury, particularly in the event of sudden braking or a sudden change in direction.

- ▶ Always stow objects in such a way that they cannot be thrown around.
- ▶ Before the journey, secure objects, luggage or loads against slipping or tipping over.

Observe the notes on loading the vehicle.

Through-loading feature without cargo compartment cover

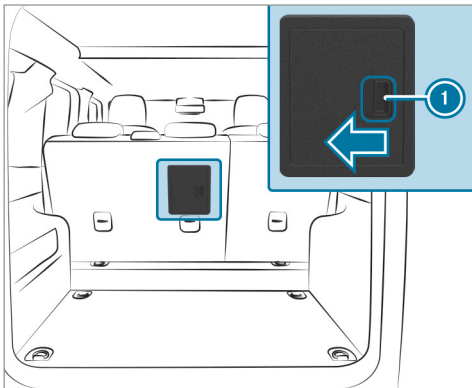

- ▶ Fold down the rear armrest.
- ▶ Pull the center head restraint of the rear bench seat fully upwards.
- ▶ Slide release catch ① to the left.

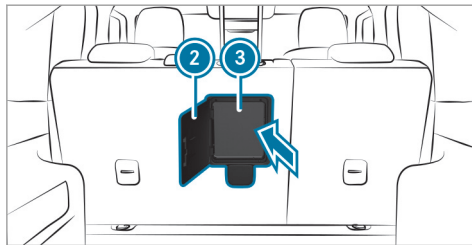

- ▶ Swivel flap ② to the left until it comes to rest on the rear side of the rear bench seat.
- ▶ Push cover ③ forwards until it comes to rest on the rear armrest.

Through-loading feature with cargo compartment cover

- ▶ Fold the seat backrest forwards (→ page 96).

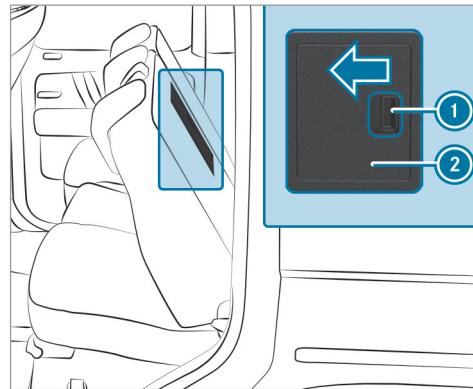

- ▶ Slide release catch ① to the left.
- ▶ Swivel flap ② to the left until it comes to rest on the rear side of the rear bench seat.
- ▶ Fold the seat backrest back and fold the rear armrest down.

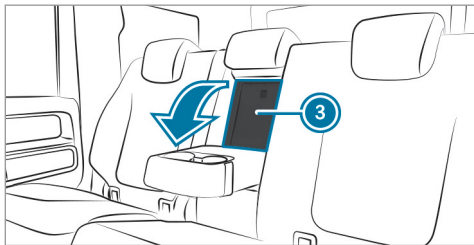

- ▶ Fold cover ③ forwards until it comes to rest on the rear armrest.
- ▶ Pull the center head restraint of the rear bench seat fully upwards.

Folding the rear bench seat forwards

⚠ WARNING Risk of injury if the rear bench seat/rear seat and seat backrest are not engaged

If the rear bench seat/rear seat and seat backrest are not engaged they could fold forwards, e.g. when braking suddenly or in the event of an accident.

- If this is the case, the vehicle occupant would be forced into the seat belt by the rear bench seat/rear seat or by the seat backrest. The seat belt cannot protect as intended and could result in additional injury.
 - Objects or loads in the trunk/cargo compartment cannot be restrained by the seat backrest.
- ▶ Make sure that the seat backrest and the rear bench seat are engaged before every trip.

! NOTE Damage to the seat backrests

The seat backrests may be damaged when the rear bench seat is folded forwards.

- ▶ Fold the rear bench seat's cushion upwards before the rear seat backrest is folded forwards.

The left and right seat backrests can be folded forwards separately.

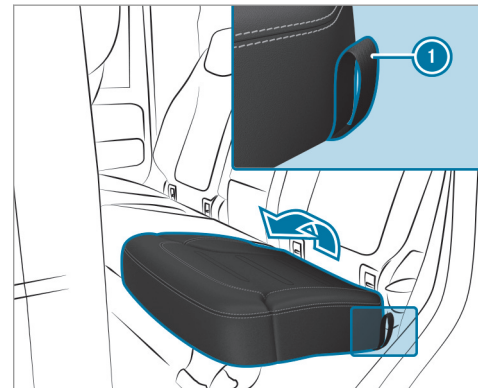

- ▶ Fully insert the seat backrest head restraints (→ page 83).
- ▶ Fold the seat cushion upwards using the loop ①.

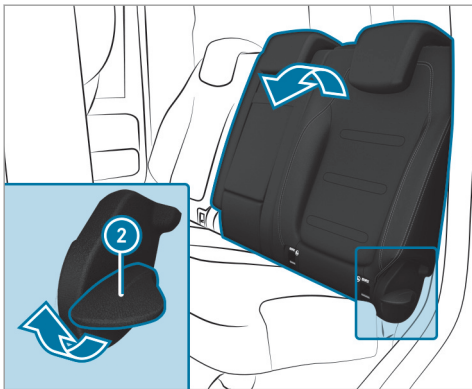

- ▶ Pull release handle ② upwards until the seat backrest is completely unlocked.
- ▶ Fold the seat backrest forwards.

Folding back the rear bench seat

! NOTE Damage to the seat belt

The seat belt could become trapped and thus damaged when folding back the seat backrest.

- ▶ Make sure that the seat belt is not trapped when folding back the seat backrest.

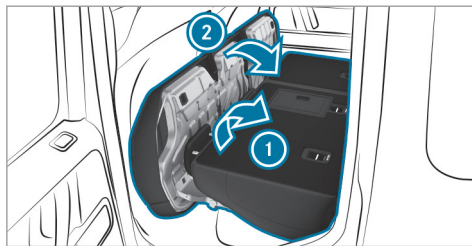

- ▶ Swivel seat backrest ① back until it engages.
- ▶ Swivel seat cushion ② back.

Rear seat backrests

Adjusting the angle of the rear seat backrests

⚠ WARNING Risk of injury if the rear bench seat/rear seat and seat backrest are not engaged

If the rear bench seat/rear seat and seat backrest are not engaged they could fold forwards, e.g. when braking suddenly or in the event of an accident.

- If this is the case, the vehicle occupant would be forced into the seat belt by the rear bench seat/rear seat or by the seat backrest. The seat belt cannot protect as intended and could result in additional injury.
- Objects or loads in the trunk/cargo compartment cannot be restrained by the seat backrest.
- ▶ Make sure that the seat backrest and the rear bench seat/rear seat are engaged before every trip.

You can adjust the angle of the rear seat backrests. There are several possible detent positions.

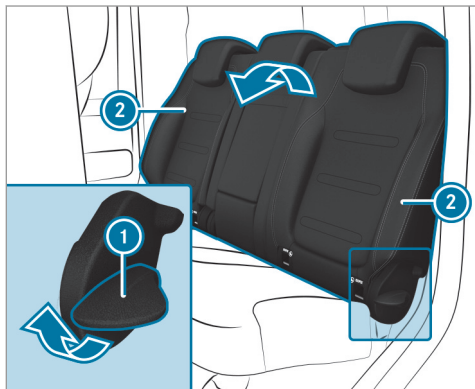

- ▶ Pull the left or right release lever ① in the direction of the arrow and hold it in position.
- ▶ Move seat backrest ② to the desired angle.
- ▶ Let go of release lever ①.
- ▶ Ensure that the seat backrest is engaged.

Cargo compartment cover

Extending/retracting the cargo compartment cover

⚠ WARNING Risk of injury or death due to objects being poorly secured

On its own, the cargo compartment cover cannot secure or restrain heavy objects, items of luggage and heavy loads.

You could be hit by an unsecured load during sudden changes in direction, braking or in the event of an accident.

- ▶ Always stow objects in such a way that they cannot be thrown around.
- ▶ Secure objects, luggage or loads against slipping or tipping over, e.g. by using tie-downs, even if you are using the cargo compartment cover.

! NOTE Damage to the cargo compartment cover when loading the vehicle

The cargo compartment cover may be damaged when loading the vehicle.

- ▶ Do not place any objects above the lower edge of the side windows or on the cargo compartment cover.

The cargo compartment cover is attached behind the seat backrest of the rear bench seat.

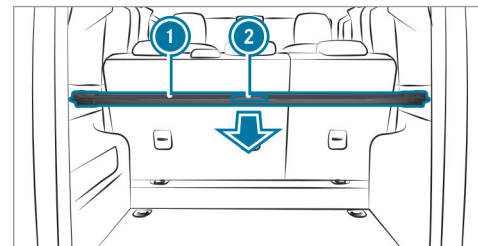

- ▶ **To extend:** pull cargo compartment cover ① back by grab handle ② until it engages.

- ▶ **To retract:** push the rear edge of the cargo compartment cover ① downwards. The cargo compartment cover ① automatically moves forwards.

For easier loading, the cargo compartment cover can be folded upwards.

Installing/removing the cargo compartment cover

Requirements:

- The cargo compartment cover is retracted.

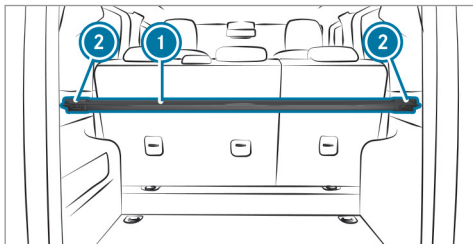

- ▶ **To remove:** press in the end cap of cargo compartment cover ① on the right- or left-hand side.
- ▶ Push cargo compartment cover ① into recess ② on the opposite side.
- ▶ Take cargo compartment cover ① out by pulling it upwards.
- ▶ **To install:** place cargo compartment cover ① into recess ② on the right- or left-hand side.
- ▶ Press in the end cap of cargo compartment cover ① on the opposite side and insert cargo compartment cover ① into the other recess ②.
- ▶ Slide the end cap outwards.

Attaching/removing the partition net

⚠ WARNING Risk of injury or death due to objects being poorly secured

On its own, the partition net cannot secure or restrain heavy objects, items of luggage and heavy loads.

You could be hit by an unsecured load during sudden changes in direction, braking or in the event of an accident.

- ▶ Always stow objects in such a way that they cannot be thrown around.
- ▶ Secure objects, luggage or loads against slipping or tipping over, e.g. by using lashing material, even when you are using the partition net.

For safety reasons, always use a partition net when transporting a load.

Damaged partition nets can no longer fulfill their protective functions and must be replaced. Visit a qualified specialist workshop.

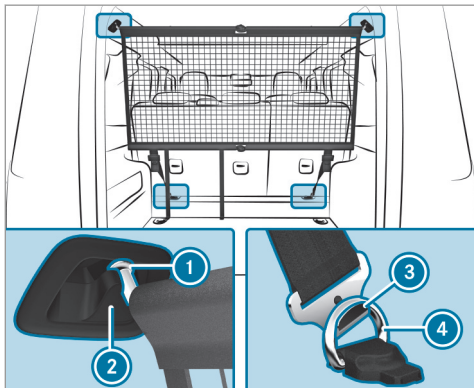

Partition net without cargo compartment enlargement

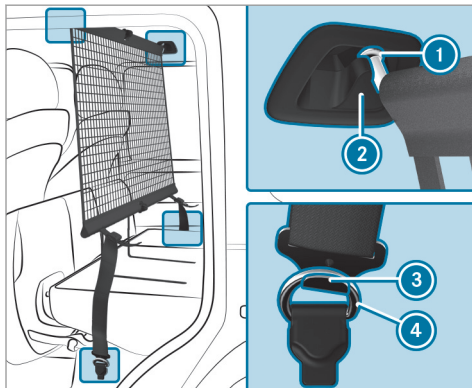

Partition net with cargo compartment enlargement

- ▶ Extend and unfold the partition net. The joints on the top and bottom guide rods will engage audibly.
- ▶ **To attach:** attach guide rod ① on the headliner to holders ②.

- ▶ Engage hooks ③ in tie-down eyes ④ on the left and right.
- ▶ Pull at the loose ends of the lashing straps until the partition net is tight.
- ▶ After driving a short distance, check the tension of the partition net and re-tension it if necessary.

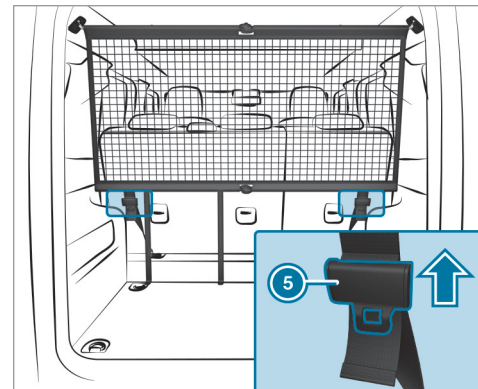

- ▶ **To remove:** pull belt clamp ⑤ upwards until the tie-down straps are loose.
- ▶ Remove hooks ③ from tie-down eyes ④ on the left and right.
- ▶ Remove guide rod ① from holders ②.
- ▶ **To stow:** press the red buttons on the top and bottom guide rods.
- ▶ Fold up and retract the partition net.

Overview of the tie-down eyes

Observe the notes on loading the vehicle (→ page 90).

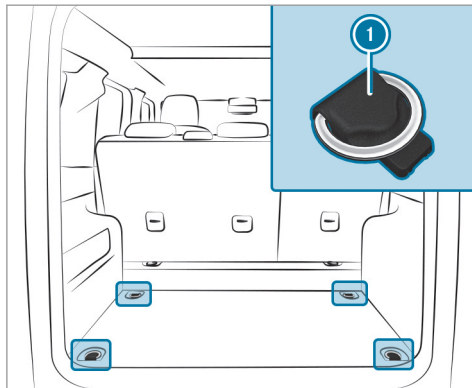

① Tie-down eyes for securing loads

Overview of bag hooks

⚠ WARNING Risk of injury when using bag hooks with heavy objects

The bag hooks cannot restrain heavy objects or items of luggage.

Objects or items of luggage could be thrown around and thereby hit vehicle occupants when braking or abruptly changing directions.

- ▶ Only hang light objects on the bag hooks.
- ▶ Never hang hard, sharp-edged or fragile objects on the bag hooks.

Observe the notes on loading the vehicle (→ page 90).

The bag hooks can bear a maximum load of 6.6 lbs (3 kg). Do not use them to secure a load.

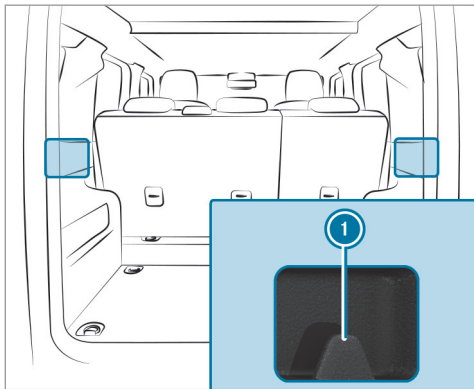

① Bag hook

Attaching the roof carrier

⚠ WARNING Risk of accident due to transport of objects on the roof

When you load the roof, the vehicle center of gravity rises and the driving characteristics

change. As a result, the driving characteristics, as well as the steering and braking characteristics, are greatly impaired

▶ Do not transport any objects on the roof.

▶ Comply with the notes on loading the vehicle (→ page 90).

Cup holder

Installing the cup holder in or removing it from the center console

⚠ WARNING - Risk of accident or injury when using the cup holder while the vehicle is moving

The cup holder cannot secure containers while the vehicle is moving.

If you use a cup holder while the vehicle is moving, the container may be flung around and liquids may be spilled. The vehicle occupants may come into contact with the liquid

and if it is hot, they could be scalded. You could be distracted from traffic conditions and you may lose control of the vehicle.

▶ Only use the cup holder when the vehicle is stationary.

▶ Only use the cup holder for containers of the right size.

▶ Close the container, particularly if the liquid is hot.

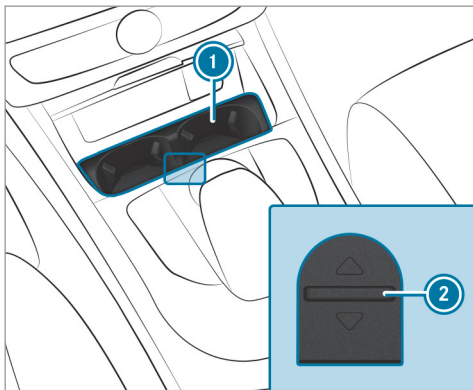

▶ **To remove:** slide catch ② forwards and pull out cup holder ①.

▶ **To install:** insert cup holder ① and slide back catch ②.

ⓘ The cup holder rubber mat can be removed for cleaning, e.g. using clean, lukewarm water.

ⓘ Observe the notes on loading the vehicle (→ page 90).

Using the cup holder in the rear armrest

! **NOTE** Damage to the rear armrest

When folded out, the rear armrest can be damaged by the weight of your body.

▶ Do not sit or support yourself on the rear armrest.

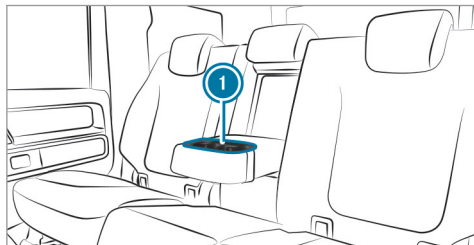

▶ Fold down the rear seat armrest.

▶ Place the container into the cup holder ① or remove it.

Ashtray and cigarette lighter

Using the ashtray

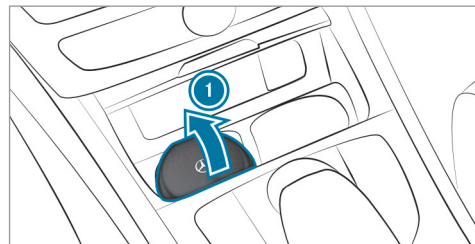

▶ **During a journey:** place the closed ashtray in the cup holder in the center console.

▶ Check that it is seated firmly.

▶ Comply with the notes on loading the vehicle (→ page 90).

▶ **To open:** fold lid ① upwards.

ⓘ Twist the top part of the ashtray to remove it for cleaning, e.g. with clean, lukewarm water, or for emptying.

Using the rear passenger compartment ash-tray

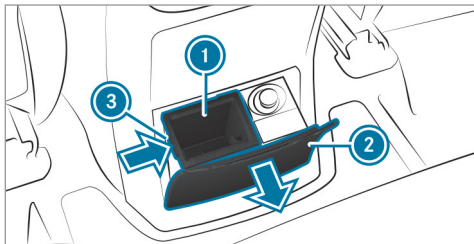

- ▶ **To open:** pull cover ② out by its top handle edge.
- ▶ **To remove the insert:** push ribbing ③ from the left side and pull insert ① upwards and out.
- ▶ **To install the insert:** install insert ① from above and press down into the holder until it engages.

Using the cigarette lighter in the front center console

⚠ WARNING - Risk of fire and injury from hot cigarette lighter

You can burn yourself if you touch the hot heating element or the socket of the cigarette lighter.

In addition, flammable materials may ignite if:

- you drop the hot cigarette lighter
- a child holds the hot cigarette lighter to objects, for example

- ▶ Always hold the cigarette lighter by the knob.
- ▶ Always make sure that the cigarette lighter is out of reach of children.
- ▶ Never leave children unattended in the vehicle.

Requirements:

- The ignition is switched on.

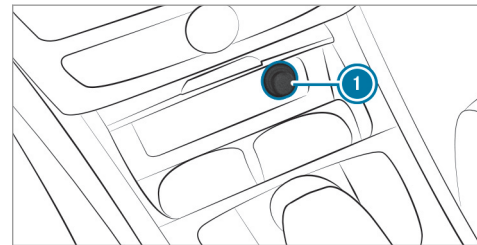

- ▶ Press in cigarette lighter ①.
The cigarette lighter will pop out automatically when the heating element is red-hot.

Using the cigarette lighter in the rear passenger compartment

Requirements:

- The ignition is switched on.

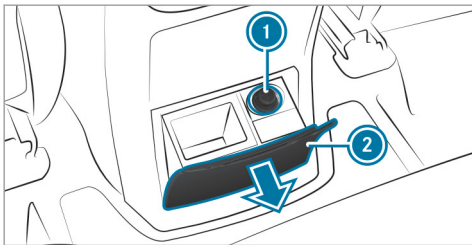

- ▶ **To open:** pull cover ② out by its top handle edge.
- ▶ Press in cigarette lighter ①. The cigarette lighter will pop out automatically when the heating element is red-hot.

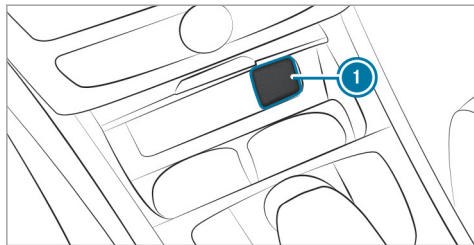

- ▶ Lift up socket cap ①.
- ▶ Insert the plug of the device.

If you have connected a device to the 12 V socket, leave the cover of the stowage compartment open.

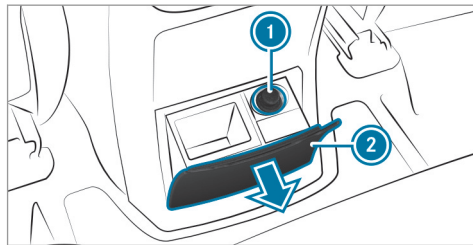

- ▶ Pull cover ② out by its top handle edge.
- ▶ Remove plug ① from the socket and insert the plug of the device.

Sockets

Using the 12 V socket in the front center console

Requirements:

- Only devices with up to a maximum of 180 watts (15 A) are permissible.

Using the 12 V socket in the rear passenger compartment

Requirements:

- Only connect devices up to a maximum of 180 W (15 A).

Using the 115 V socket in the cargo compartment

⚠ DANGER Risk of fatal injury due to damaged connecting cables or sockets

If a suitable device is connected, the 115 V socket will be carrying a high voltage. If the connecting cable or the 115 V socket is pulled out of the trim or is damaged or wet, you could receive an electric shock.

- ▶ Only use dry and damage-free connecting cables.
- ▶ When the ignition is switched off, ensure that the 115 V socket is dry.
- ▶ If the 115 V socket is damaged or gets pulled out of the paneling, immediately have the socket checked or replaced at a qualified specialized workshop.
- ▶ Never plug the connecting cable into a 115 V socket that is damaged or has been pulled out of the trim.

⚠ DANGER Risk of fatal injury due to incorrect handling of the socket

You could receive an electric shock:

- if you reach into the socket.
 - if you insert unsuitable devices or objects into the socket.
- ▶ Do not reach into the socket.
 - ▶ Only connect suitable devices to the socket.

Requirements:

- Only devices up to a maximum of 150 W are permitted.
- The ignition is switched on.

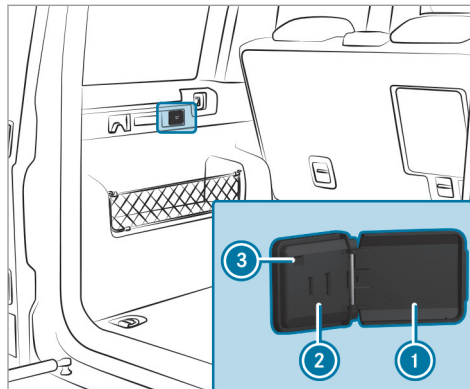

- ▶ Open flap ①.
- ▶ Insert the plug of the device into 115 V socket ②.

- ▶ When the on-board electrical system voltage is sufficient, indicator lamp ③ lights up.

Using the 12 V socket in the cargo compartment

Requirements:

- Only connect devices up to a maximum of 180 W (15 A).

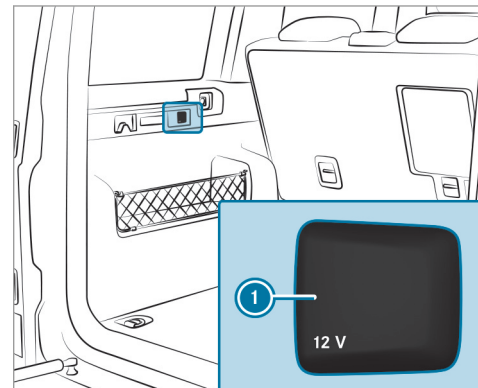

- ▶ Lift up cap ① of the socket and insert the plug of the device.

USB port in the rear passenger compartment

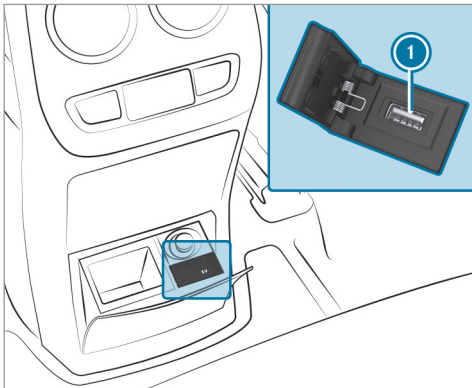

If the ignition is switched on you can charge a USB device, e.g. a mobile phone, at USB port ① using a suitable charging cable.

Wireless charging of the mobile phone and connection with the exterior antenna

Notes on wirelessly charging the mobile phone

⚠ WARNING Risk of injury due to objects being stowed incorrectly

If you do not adequately stow objects in the vehicle interior, they could slip or be tossed around and thereby strike vehicle occupants. In addition, cup holders, open stowage spaces and mobile phone brackets cannot always restrain the objects they contain in the event of an accident.

There is a risk of injury, particularly in the event of sudden braking or a sudden change in direction.

- ▶ Always stow objects in such a way that they cannot be tossed about in these or similar situations.
- ▶ Always make sure that objects do not project from stowage spaces, parcel nets or stowage nets.

- ▶ Close the lockable stowage spaces before starting a journey.
- ▶ Always stow and secure objects that are heavy, hard, pointed, sharp-edged, fragile or too large in the trunk.

Observe the notes on loading the vehicle.

⚠ WARNING Risk of fire from placing objects in the mobile phone stowage compartment

If you place objects in the mobile phone stowage compartment, they may heat up excessively and even catch fire.

- ▶ Do not place additional objects, especially those made of metal, in the mobile phone stowage compartment.

! **NOTE** Damage to objects caused by placing them in the mobile phone stowage compartment

If objects are placed in the mobile phone stowage compartment, they may be damaged by electromagnetic fields.

▶ Do not place credit cards, storage media or other objects sensitive to electromagnetic fields in the mobile phone stowage compartment.

! **NOTE** Damage to the mobile phone stowage compartment caused by liquids

If liquids enter the mobile phone stowage compartment, the compartment may be damaged.

▶ Ensure that no liquids enter the mobile phone stowage compartment.

- Depending on the vehicle equipment, the mobile phone is connected to the vehicle's exterior antenna via the charging module.

- The charging function and wireless connection of the mobile phone to the vehicle's exterior antenna are only available if the ignition is switched on.
- Small mobile phones may not be able to be charged in every position of the mobile phone stowage compartment.
- Large mobile phones which do not rest flat in the mobile phone stowage compartment may not be able to be charged or connected with the vehicle's exterior antenna.
- The mobile phone may heat up during the charging process. This depends on the applications (apps) currently running.
- To ensure more efficient charging and connection with the vehicle's exterior antenna, remove the protective cover from the mobile phone. Protective covers which are designed for wireless charging are excluded.
- When charging, the mat should be used if possible.

Wireless charging of the mobile phone in the front

Requirements:

- The mobile phone must be suitable for wireless charging (Qi-compatible mobile phone). You can find a list of Qi-compatible mobile phones at:

<http://www.mercedes-benz.com/connect>

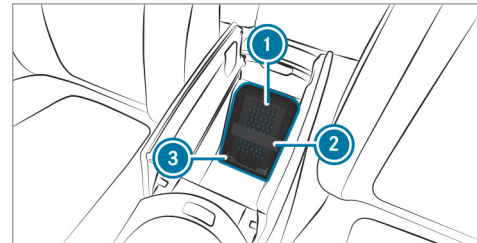

- ① Mat
- ② Rubber strap
- ③ Tray

▶ Place the mobile phone as close to the center of mat ① as possible with the display

facing upwards and secure it with rubber strap ②.

When the charging symbol is shown in the multimedia system, the mobile phone is being charged.

Malfunctions detected during the charging process are shown in the multimedia system display.

- ① The mat can be removed for cleaning, e.g. using clean, lukewarm water, by unclipping it.

Installing/removing the floor mats

⚠ WARNING Risk of accident due to objects in the driver's footwell

Objects in the driver's footwell may impede pedal travel or block a depressed pedal.

This jeopardizes the operating and road safety of the vehicle.

- ▶ Stow all objects in the vehicle securely so that they cannot get into the driver's footwell.
- ▶ Always install the floor mats securely and as prescribed in order to ensure that there is always sufficient room for the pedals.
- ▶ Do not use loose floor mats and do not place floor mats on top of one another.

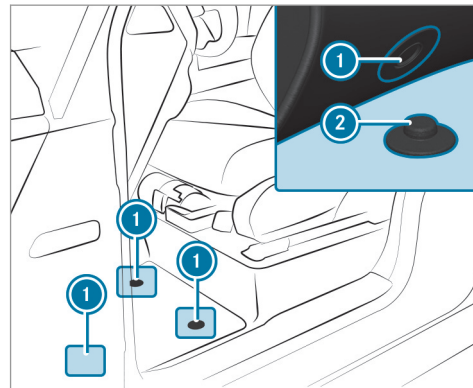

- ▶ **To install:** move the seat backwards and lay the floor mat in the footwell.
- ▶ Press studs ① onto holders ②.
- ▶ Adjust the corresponding seat.
- ▶ **To remove:** pull the floor mat off holders ②.
- ▶ Remove the floor mat.

Exterior lighting

Information about lighting systems and your responsibility

The various lighting systems of the vehicle are only aids. The driver of the vehicle is responsible for correct vehicle illumination in accordance with the prevailing light and visibility conditions, legal requirements and traffic situation.

Light switch

Operating the light switch

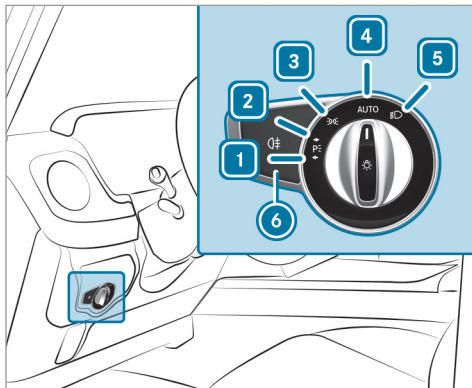

- 1 Left standing light
- 2 Right standing light
- 3 Parking lights and license plate lamp
- 4 **AUTO** Automatic driving lights (preferred light switch position)

- 5 Low beam/high beam
- 6 Switches the rear fog lights on or off

When low beam is activated, the indicator lamp for the parking lights is deactivated and replaced by the low beam indicator lamp.

▶ Always park your vehicle safely and in a well-lit area, in accordance with the relevant legal stipulations.

! **NOTE** Battery discharging by operating the standing lights

Operating the standing lights over a period of hours puts a strain on the battery.

▶ Where possible, switch on the right or left parking light.

In the case of severe battery discharging, the standing lights or parking lights are automatically switched off to facilitate the next engine start.

The exterior lighting (except standing and parking lights) switches off automatically when the driver's door is opened.

- Observe the notes on surround lighting (→ page 113).

Automatic driving lights function

The parking lights, low beam and daytime running lamps are switched on automatically depending on the ignition status and the ambient light.

⚠ WARNING Risk of accident when the low beam is switched off in poor visibility

When the light switch is set to **AUTO**, the low beam may not be switched on automatically if there is fog, snow or other causes of poor visibility such as spray.

- ▶ In such cases, turn the light switch to .

The automatic driving lights are only an aid. You are responsible for vehicle lighting.

Switching the rear fog lights on or off

Requirements:

- The light switch is in the  or **AUTO** position.

- ▶ Press the  button.

Please observe the country-specific laws on the use of rear fog lamps.



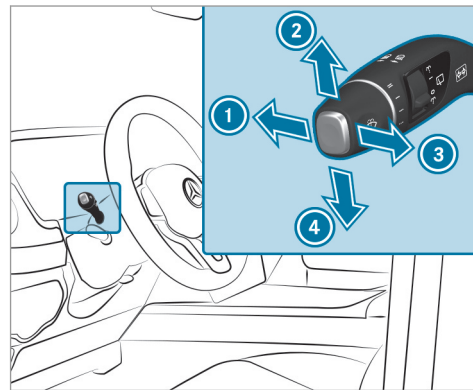

Operating the combination switch for the lights



- 1 High beam
- 2 Turn signal indicator, right
- 3 High-beam flasher
- 4 Turn signal indicator, left

- ▶ Use the combination switch to activate the desired function.



High beam



- ▶ **To switch on:** turn the light switch to the  or **AUTO** position.
- ▶ Press the combination switch beyond the point of resistance in the direction of arrow . When the high beam is activated, the  indicator lamp for low beam will be deactivated and replaced by the  indicator lamp for high beam.
- ▶ **To switch off:** move the combination switch back to its starting position.

High-beam flasher

- ▶ Pull the combination switch in the direction of arrow .

Turn signal lights

- ▶ **To indicate briefly:** press the combination switch briefly to the point of resistance in the direction of arrow  or . The corresponding turn signal indicator will flash three times.

- ▶ **To indicate permanently:** press the combination switch beyond the point of resistance in the direction of arrow  or .

Activating/deactivating the hazard warning lights

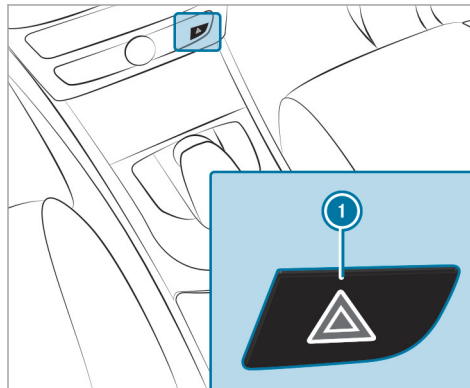

- ▶ Press button .

Adaptive Highbeam Assist

Adaptive Highbeam Assist function

⚠ WARNING Risk of accident despite Adaptive Highbeam Assist

Adaptive Highbeam Assist does not recognize the following road users:

- Road users without lights, e.g. pedestrians
- Road users with poor lighting, e.g. cyclists
- Road users whose lighting is obstructed, e.g. by a barrier

On very rare occasions, Adaptive Highbeam Assist may fail to recognize other road users with their own lighting, or may recognize them too late.

In these or similar situations, the automatic high beam is not deactivated or is activated despite the presence of other road users.

- ▶ Always observe the traffic carefully and switch off the high beam in good time.

Adaptive Highbeam Assist cannot take into account road, weather or traffic conditions.

Detection may be restricted:

- In poor visibility, e.g. fog, heavy rain or snow
- There is dirt on the sensors or the sensors are obscured.

Adaptive Highbeam Assist is only an aid. You are responsible for adjusting the vehicle's lighting to the prevailing light, visibility and traffic conditions.

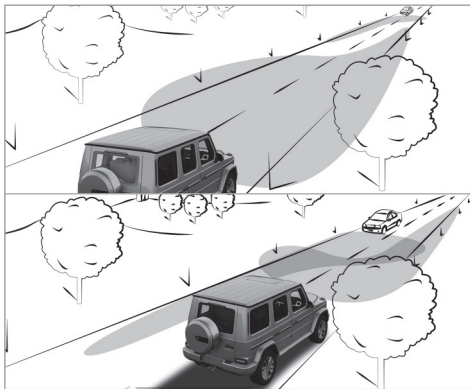

Adaptive Highbeam Assist switches automatically between:

- Low-beam headlamps
- High-beam headlamps

At speeds above 19 mph (30 km/h):

- If no other road users are detected, the high beam will be switched on automatically.

The high beam switches off automatically:

- At speeds below 16 mph (25 km/h).
- If other road users are detected.
- If street lighting is sufficient.

At speeds above approximately 31 mph (50 km/h):

- The headlamp range of the low beam is regulated automatically based on the distance to other road users.

The system's optical sensor is located behind the windshield near the overhead control panel.

Switching Adaptive Highbeam Assist on/off

- ▶ **To switch on:** turn the light switch to the **AUTO** position.
- ▶ Switch on the high beam using the combination switch. When the high beam is switched on automatically in the dark, the  indicator lamp on the multifunction display comes on.
- ▶ **To switch off:** switch off the high beam using the combination switch.

Switching the daytime running lamps on/off

Multimedia system:

- Vehicle ➤  Light Settings
- Daytime Run. Lights

▶ Activate or deactivate the function.

Setting the exterior lighting switch-off delay time

Multimedia system:

- Vehicle ➤  Light Settings
- Ext. Light Switch Off

▶ Set the switch-off delay time.

Setting the surround lighting

Multimedia system:

- Vehicle ➤  Light Settings
- Locator Lighting

▶ Activate or deactivate the function.

If the surround lighting is switched on, the exterior lighting remains lit for 40 seconds after the





vehicle is unlocked. When you start the vehicle, the surround lighting is deactivated and the automatic driving lights are activated.

Interior lighting

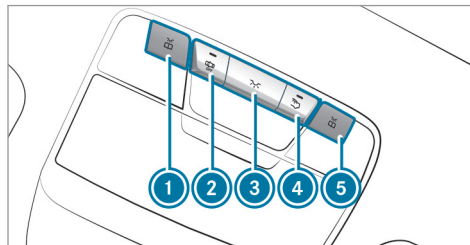
Adjusting the interior lighting

Front overhead control panel



- ①  Front left reading lamp
- ②  Automatic interior lighting control
- ③  Front interior lighting
- ④  Rear interior lighting
- ⑤  Front right reading lamp

▶ **To switch on or off:** press button ① – ⑤ accordingly.

Control panel in the grab handle

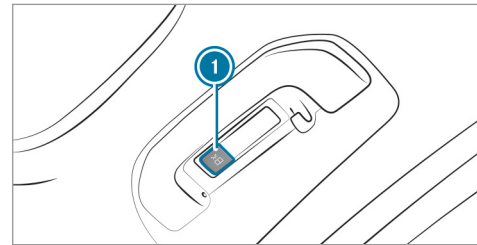

①  Rear reading lamp

▶ **To switch on or off:** press button ①.

Adjusting the ambient lighting

Multimedia system:

- Vehicle ➤  Light Settings
- Ambient Light

Setting the color

- ▶ Select **Color**.
- ▶ Set a color.

Adjusting the brightness

- ▶ Select **Brightness**.
- ▶ Set a brightness value.

Activating the brightness for zones

- ▶ Select **Brightness Zones**.
- ▶ Activate or deactivate the function. The **Display**, **Front** and **Rear** zones can be set separately.

Activating multi-color lighting

- ▶ Select **Multi-color**.
- ▶ Activate or deactivate the function. There are ten preset color combinations available.

Activating multi-color animation

- ▶ Select **Multi-color Anim..**
- ▶ Activate or deactivate the function. The chosen color combination changes at predefined intervals.

Activating dependency on air conditioning settings

- ▶ Select **Climate**.
- ▶ Activate or deactivate the function. If changes are made to the temperature setting in the vehicle, the color of the ambient lighting changes briefly.

Activating welcome lighting

- ▶ Select **Welcome**.
- ▶ Activate or deactivate the function. When the vehicle is unlocked, a special interior lighting sequence runs.

Setting the interior lighting switch-off delay time

Multimedia system:

- Vehicle ➤  Light Settings
- Int. Light Switch Off
- ▶ Set the switch-off delay time.

Windshield wiper and windshield washer system

Switching the windshield wipers on/off

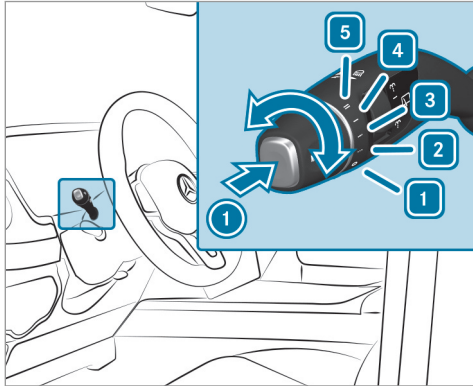



- 1 0 Windshield wipers off
- 2 ... Intermittent wiping, normal
- 3 Intermittent wiping, frequent

- 4 — Continuous wiping, slow
- 5 == Continuous wiping, fast



▶ Turn the combination switch to the corresponding position 1 - 5.

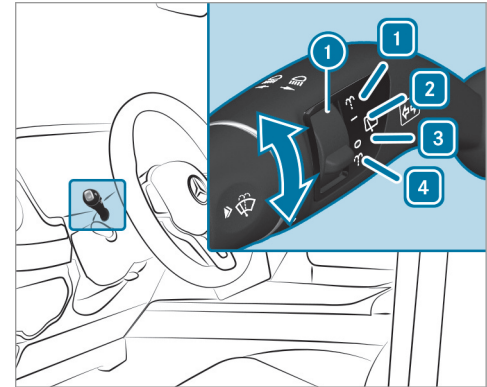

▶ **Single wipe/washing:** push the button on the combination switch in the direction of arrow 1.

-  Single wipe
-  Wipes with washer fluid

Switching the rear window wiper on/off



- 1  Wipes with washer fluid
- 2 — Switches on intermittent wiping
- 3 0 Switches off intermittent wiping
- 4  Wipes with washer fluid

- ▶ Turn  switch ① to the correct position 1 - 4. The  symbol appears on the instrument cluster when the rear window wiper is switched on.

Changing the windshield wiper blades

⚠ WARNING Risk of becoming trapped if the windshield wipers are switched on while wiper blades are being replaced

If the windshield wipers begin to move while you are changing the wiper blades, you can be trapped by the wiper arm.

- ▶ Always switch off the windshield wipers and the ignition before changing the wiper blades.

Removing the wiper blades

- ▶ Fold the wiper arms away from the windshield.

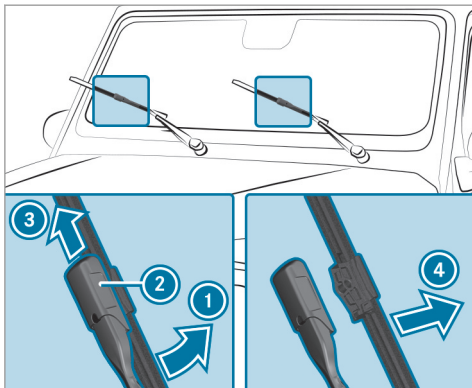

- ▶ Hold the wiper arm with one hand. With the other hand, turn the wiper blade in the direction of arrow ① away from the wiper arm as far as it will go.
- ▶ Slide catch ② in the direction of arrow ③ until it engages in the removal position.
- ▶ Remove the wiper blade from the wiper arm in the direction of arrow ④.

Installing the wiper blades

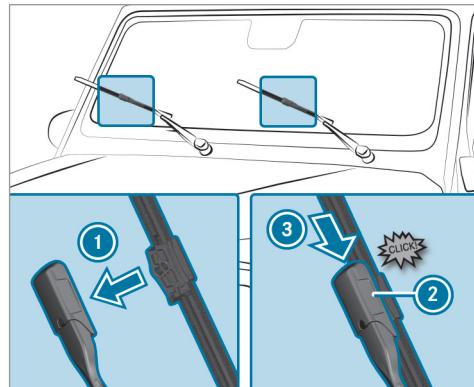

- ▶ Insert the new wiper blade into the wiper arm in the direction of arrow ①.
- ▶ Slide catch ② in the direction of arrow ③ until it engages in the locking position.
- ▶ Make sure that the wiper blade sits correctly.
- ▶ Fold the wiper arms back onto the windshield.

Maintenance display

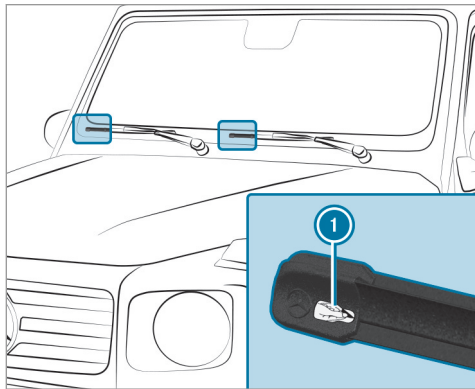

- ▶ Remove protective film ① from the maintenance display on the tip of the newly installed wiper blades.

If the color of the maintenance display changes from black to yellow, the wiper blades should be replaced.

- ① The duration until the color changes varies depending on the usage conditions.

Changing the rear window wiper blade

- ⚠ **WARNING** Risk of becoming trapped if the windshield wipers are switched on while wiper blades are being replaced

If the windshield wipers begin to move while you are changing the wiper blades, you can be trapped by the wiper arm.

- ▶ Always switch off the windshield wipers and the ignition before changing the wiper blades.

! NOTE Damage to the rear window

If the wiper arm falls onto the rear window without the wiper blade attached, this may damage the rear window.

- ▶ Securely hold the wiper arm while changing the wiper blade or carefully lower it onto the rear window.

Removing the wiper blade

- ▶ Switch off the ignition (→ page 126).
- ▶ Within approximately 15 seconds, turn the combination switch to position ① (→ page 115). The wiper arm moves into the change position.

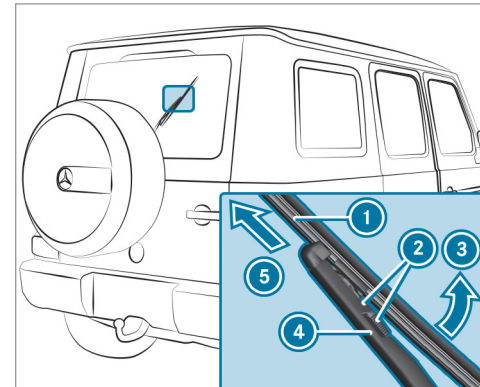

- ▶ Fold wiper arm ④ away from the rear window and hold it tightly.
- ▶ Press both release clips ②.
- ▶ Fold wiper blade ① in the direction of arrow ③ away from wiper arm ④.
- ▶ Remove wiper blade ① in the direction of arrow ⑤.

Installing the wiper blade

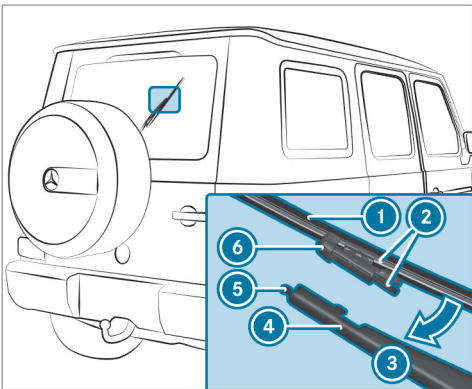

- ▶ Position wiper blade ① with recess ⑥ on lug ⑤.
- ▶ Fold wiper blade ① in the direction of arrow ③ onto the wiper arm until retaining clips ② engage in bracket ④.
- ▶ Make sure wiper blade ① is sitting correctly.
- ▶ Fold the wiper arm back onto the rear window.

Mirrors

Operating the outside mirrors

- ▶ **WARNING** Risk of injury from adjusting the vehicle settings while the vehicle is in motion

You could lose control of the vehicle in the following situations:

- if you adjust the driver's seat, the head restraint, the steering wheel or the mirror while the vehicle is in motion
- if you fasten your seat belt while the vehicle is in motion

- ▶ Before starting the engine: adjust the driver's seat, the head restraint, the steering wheel or the mirror and fasten your seat belt.

- ▶ **WARNING** Risk of accident due to misjudgment of distances when using the passenger mirror

The outside mirror on the front-passenger side reflects objects on a smaller scale. The objects in view are in fact closer than they appear.

As a result, you may misjudge the distance between you and the road user driving behind you, for example, when changing lanes.

- ▶ Therefore, always look over your shoulder in order to ensure that you are aware of the actual distance between you and the road users driving behind you.

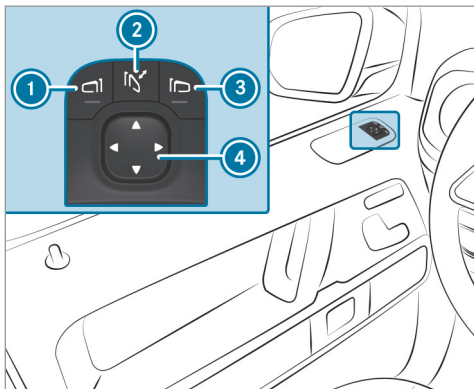

▶ **To fold in or out:** briefly press button ②.

▶ **To set:** press button ① or ③ to select the outside mirror to be adjusted.

▶ Press button ④ to adjust the position of the mirror glass.

ⓘ If the battery has been disconnected or completely discharged, you will have to reset the

outside mirrors. Only then will the automatic mirror folding function work properly.

▶ **To adjust:** briefly press button ②.

An outside mirror that has been pushed out of position can be engaged in position again as follows:

▶ Press and hold button ②.

You will hear a click and the mirror will audibly engage in position. The outside mirror will now be set to the correct position.

Automatic anti-glare mirrors function

⚠ WARNING Risk of burns and poisoning due to the anti-glare mirror electrolyte

Electrolyte may escape if the glass in an automatic anti-glare mirror breaks.

The electrolyte is harmful and causes irritation. It must not come into contact with your skin, eyes, respiratory organs or clothing or be swallowed.

▶ If you come into contact with electrolyte, observe the following:

- Rinse the electrolyte from your skin and seek medical attention immediately.
- If electrolyte comes into contact with your eyes, rinse them thoroughly with clean water and seek medical attention immediately.
- If the electrolyte is swallowed, immediately rinse your mouth out thoroughly. Do not induce vomiting. Seek medical attention immediately.
- Immediately change out of clothing which has come into contact with electrolyte.
- If an allergic reaction occurs, seek medical attention immediately.

The inside rearview mirror and the outside mirror on the driver's side automatically go into anti-glare mode if light from a headlamp hits the sensor on the inside rearview mirror.

System limitations

The system does not go into anti-glare mode in the following situations:

- the engine is switched off
- reverse gear is engaged
- the interior lighting is switched on

Function of the front-passenger outside mirror parking position

The parking position makes parking easier.

The front-passenger outside mirror tilts downwards and shows the rear wheel on the front-passenger side in the following situations:

- the parking position is stored (→ page 120)
- the passenger mirror is selected
- reverse gear is engaged

The front-passenger outside mirror moves back to its original position in the following situations:

- you shift the transmission to another transmission position
- at speeds greater than 9 mph (15 km/h)

- you press the button for the outside mirror on the driver's side

Storing the parking position of the front-passenger outside mirror using reverse gear

Storing

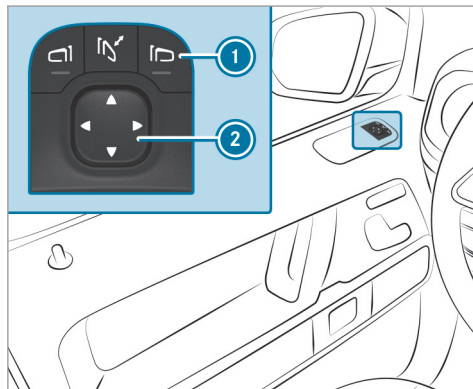

- ▶ Press button ① to select the front-passenger outside mirror.
- ▶ Engage reverse gear.
- ▶ Move the front-passenger outside mirror into the desired parking position using button ②.

Calling up

- ▶ Press button ① to select the front-passenger outside mirror.
- ▶ Engage reverse gear.
The front-passenger outside mirror will move to the stored parking position.

Activating/deactivating the automatic mirror folding function

Multimedia system:

- ▶ [Vehicle](#) ▶ [Vehicle Settings](#)
- ▶ [Autom. Mirror Folding](#)
- ▶ Activate or deactivate the function.

Operating the sun visor

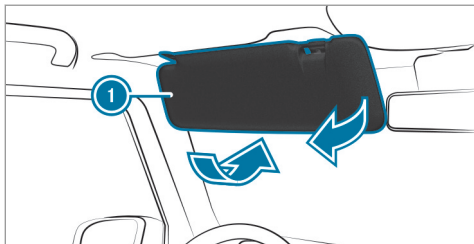

- ▶ **Glare from the front:** fold sun visor ① down.
- ▶ **Glare from the side:** swing sun visor ① to the side.

Area permeable to radio waves on the windshield

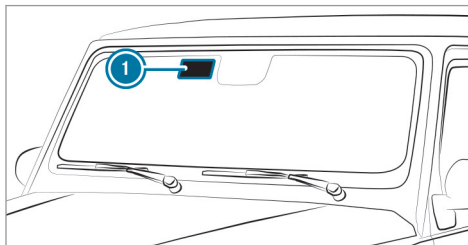

Vehicles with windshield heater: Radio-controlled equipment, such as toll systems, can be mounted only on areas of the windshield ① that are permeable to radio waves.

The area that is permeable to radio waves is always located on the front-passenger side.

Area permeable to radio waves ① is best visible from outside the vehicle when the windshield is illuminated with an additional light source.

Overview of climate control systems

Notes on climate control

An interior air filter must always be used so that the air conditioning system, pollution level monitoring and the air filtering function work correctly. Make sure that the filter is installed correctly and the filter housing in the engine compartment is closed correctly using the cap and always tightly sealed when in operation. Use filters recommended and approved by Mercedes-Benz. Always have service work carried out at a qualified specialist workshop.

Control panel overview for 3-zone automatic climate control

The indicator lamps in the buttons indicate that the corresponding function is activated.

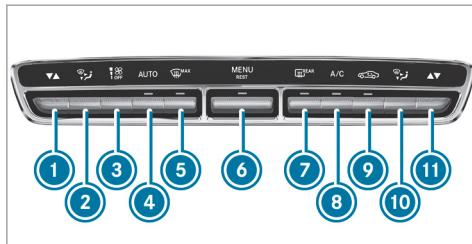

- ① Sets the driver's side temperature
- ② Sets the driver's side air distribution
- ③ Sets the airflow or switches off climate control
- ④ **AUTO** Sets climate control to automatic mode (→ page 123)
- ⑤ Defrosts the windshield
- ⑥ **MENU REST** Calls up the air conditioning menu
Switches residual heat on or off (→ page 124)
- ⑦ Switches the rear window defroster on or off
- ⑧ **A/C** Switches the A/C function on or off (→ page 123)

- ⑨ Switches air-recirculation mode on or off (→ page 124)
- ⑩ Sets the front passenger side air distribution
- ⑪ Sets the front passenger side temperature

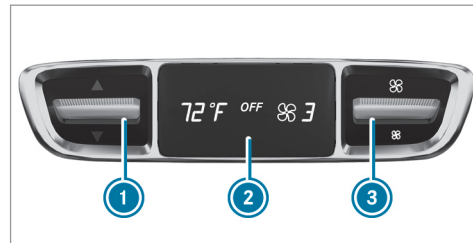

Rear operating unit



- ① Sets the temperature
- ② Display
- ③ Sets the airflow

Operating the climate control system

Switching climate control on/off

- ▶ **To switch on:** set the airflow to level 1 or higher using the  button.
 - ▶ **To switch off:** set the airflow to level 0 using the  button.
- i** If climate control is switched off, the windows may fog up more quickly. Switch off climate control only briefly.

Switching the A/C function on/off via the control panel

The A/C function heats, cools and dehumidifies the vehicle's interior air.

- ▶ Press the  button.

Switch off the A/C function only briefly otherwise the windows may fog up more quickly. Condensation may drip from the underside of the vehicle when cooling mode is active. This is not a sign that there is a malfunction.

The compressor function is deactivated in the following cases:

- When driving uphill or downhill at a gradient of more than 35 %
- When driving across an incline of more than 35 %

Activating/deactivating the A/C function via the multimedia system

Multimedia system:

- ↳ Vehicle ▶  Climate Control ▶ A/C



The A/C function heats, cools and dehumidifies the vehicle's interior air.

- ▶ Activate or deactivate the function.

Setting climate control to automatic mode

In automatic mode, the set temperature is controlled and maintained at a constant level by the air supply.

- ▶ Press the  button.

- ▶ **To switch to manual mode:** press the  or  button.

Climate style

Climate style function

In automatic mode, you can select the following climate style settings for the driver's and front passenger areas:

- **FOCUS:** high airflow, slightly cooler setting
- **MEDIUM:** medium airflow, standard setting
- **DIFFUSE:** low airflow, slightly warmer and draft-free setting

Adjusting the climate mode settings









Multimedia system:

- ↳ Vehicle ▶  Climate Control
- ▶ Climate Mode

- ▶ Select **Driver** and/or **Passenger**.
 - ▶ Select **FOCUS**, **MEDIUM** or **DIFFUSE**.
- i** To feel the effect of the climate style, the  function must be active (→ page 123).

Overview of the air distribution settings

The symbols on the display indicate which vents the airflow is being directed through:

-  defroster vents
-  center and side air vents
-  footwell vents
-  center, side and footwell vents
-  defroster and footwell vents
-  all vents
-  defroster, middle and side air vents
-  automatic air distribution

Activating or deactivating the climate control synchronization function using the multimedia system

Multimedia system:

-  Vehicle   Climate Control
-  SYNC



The climate control can be controlled centrally using the synchronization function. The tempera-

ture setting is automatically adopted for all climate zones.



-  Activate or deactivate the function.

Removing condensation from the windows

Windows fogged up on the inside

-  Press the **AUTO** button.
-  If the windows continue to fog up: press the  button.

Windows fogged up on the outside

-  Switch on the windshield wipers.
-  Press the **AUTO** button.

Switching air-recirculation mode on/off

-  Press the  button.
The interior air will be recirculated.

Air-recirculation mode automatically switches to fresh air mode after some time.

-  If air-recirculation mode is switched on, the windows may fog up more quickly. Switch on air-recirculation mode only briefly.

Switching the residual heat on or off

Requirements:

- The vehicle is parked.

It is possible to make use of the residual heat from the engine to continue heating or ventilating the front compartment of the vehicle for approximately 30 minutes.

-  **To switch on:** press the  button.

Residual heat is switched off automatically.

Activating/deactivating ionization

Multimedia system:

-  Vehicle   Climate Control
-  Ionization

Ionization cleans and refreshes the interior air of the vehicle. The ionization of the interior air is odorless.

- ▶ Activate or deactivate the function.

Information on the windshield heater

The windshield heater is switched on automatically if the  button is activated.

After the vehicle is started, the windshield heater is switched on automatically as required.

Air vents

Adjusting the front air vents

⚠ WARNING - Danger of burns or frostbite due to being too close to the air vents

Very hot or very cold air can flow from the air vents.

This could result in burns or frostbite in the immediate vicinity of the air vents.

- ▶ Make sure that all vehicle occupants always maintain a sufficient distance to the air vents.
- ▶ If necessary, direct the airflow to another area of the vehicle interior.

To guarantee the fresh air supply through the air vents into the vehicle interior, comply with the following:

- Always keep the vents and the ventilation grille in the vehicle interior free.
- Keep the air inlet free of deposits (→ page 343).

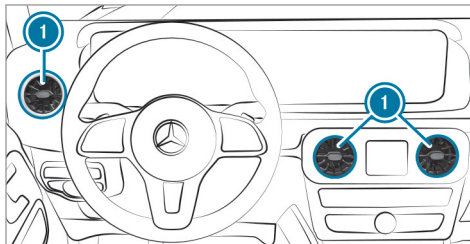

- ▶ **To open or close:** turn the center of air vent ① to the left or right as far as it will go.
- ▶ **To adjust the air direction:** hold air vent ① in the center and move it up or down or to the left or right.

Adjusting the rear air vents

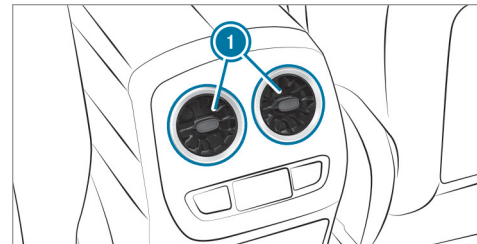

- ▶ **To open or close:** hold air vent ① in the center and turn it to the left (open) or right (closed) as far as it will go.
- ▶ **To adjust the air direction:** hold air vent ① in the center and move it up or down or to the left or right.

Driving

Notes on Mercedes-AMG vehicles

Observe the notes on the following topics in the Supplement. Otherwise, you may fail to recognize dangers.

- AMG Performance exhaust system
- AMG high-performance brake system
- AMG adaptive sport suspension system
- (DYNAMIC SELECT switch) drive programs

Switching on the power supply or ignition using the start/stop button

⚠ WARNING Risk of accident and injury due to children left unattended in the vehicle

If children are left unattended in the vehicle, they could:

- open doors, thereby endangering other persons or road users.

- get out of the vehicle and be hit by oncoming traffic.
- operate vehicle equipment and become trapped, for example.

In addition, children could also set the vehicle in motion, for example, by:

- releasing the parking brake.
- shifting the automatic transmission out of park position **P**.
- starting the engine

- ▶ Never leave children and animals unattended in the vehicle.
- ▶ When leaving the vehicle, always take the SmartKey with you and lock the vehicle.
- ▶ Keep the SmartKey out of the reach of children.

Requirements:

- The SmartKey is located in the vehicle and the SmartKey battery is not discharged.
- The brake pedal is not depressed.

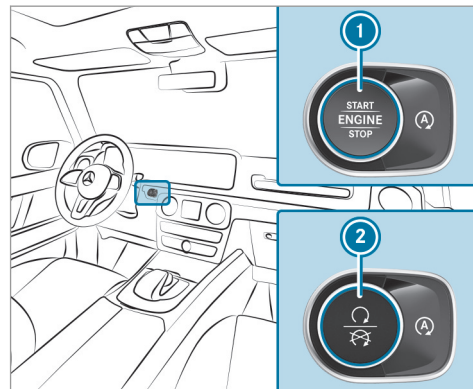

- ▶ **To switch on the power supply:** press button ① (USA) or ② (Canada) once. You can activate the windshield wipers, for example.

The power supply is switched off again if the following conditions are met:

- you open the driver's door

- you press button ① (USA) or ② (Canada) twice.

▶ **To switch on the ignition:** press button ① (USA) or ② (Canada) twice.
The indicator lamps in the instrument cluster light up.

The ignition is switched off again if one of the following conditions is met:

- You do not start the vehicle within 15 minutes.

The transmission is in position **P** or the electric parking brake has been applied.

- You press button ① once.

Starting the vehicle

Starting the vehicle with the start/stop button

Requirements:

- The SmartKey is located in the vehicle and the SmartKey battery is not discharged.

▶ Shift the transmission to position **P** or **N**.

- ▶ Depress the brake pedal and press button ① (USA) or ② (Canada) once.
- ▶ If the vehicle does not start: switch off non-essential consumers and press button ① (USA) or ② (Canada) once.
- ▶ If the vehicle still does not start and the **Place the Key in the Marked Space See Operator's Manual** display message also appears in the multifunction display: start the vehicle in emergency operation mode.

You can switch off the engine while driving by pressing button ① (USA) or ② (Canada) for about three seconds. Be sure to observe the safety notes under "Driving tips".

Starting the vehicle in emergency operation mode

If the vehicle does not start and the **Place the Key in the Marked Space See Operator's Manual** display message appears in the multifunction display, you can start the vehicle in emergency operation mode.

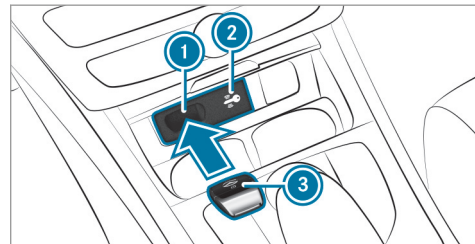

- ▶ Make sure that marked space ① is empty.
- ▶ Remove SmartKey ③ from the key ring.
- ▶ Place SmartKey ③ in marked space ① next to the symbol ②.
The vehicle will start after a short time.
If you remove SmartKey ③ from marked space ① the engine continues running. For further vehicle starts however, SmartKey ③ must be located in marked space ① during the entire journey.
- ▶ Have SmartKey ③ checked at a qualified specialist workshop.

If the vehicle does not start:

- ▶ Place SmartKey **3** in marked space **1** and leave it there.
 - ▶ Depress the brake pedal.
 - ▶ Start the vehicle using the start/stop button.
- i** You can also switch on the power supply or the ignition with the start/stop button.

Breaking-in notes

Mercedes-AMG vehicles: observe the notes in the Supplement. Otherwise, you may fail to recognize dangers.

To preserve the engine during the first 1,000 miles (1,500 km):

- Drive at varying road speeds and engine speeds.
- Drive the vehicle in drive program **C** or **E**.
- Change gear before the tachometer needle is $\frac{2}{3}$ of the way to the red area of the tachometer.

- Do not shift down a gear manually in order to brake.
- Avoid overstraining the vehicle, e.g. driving at full throttle.
- Do not depress the accelerator pedal past the pressure point (kickdown).
- Only increase the engine speed gradually and accelerate the vehicle to full speed after 1,000 miles (1,500 km).

This also applies when the engine or parts of the drivetrain have been replaced.

Please also observe the following breaking-in notes:

- In certain driving and driving safety systems, the sensors adjust automatically while a certain distance is being driven after the vehicle has been delivered or after repairs. Full system effectiveness is not reached until the end of this teach-in process.
- Brakepads, brake discs and tires that are either new or have been replaced only achieve optimum braking effect and grip after several hundred kilometers of driving. Com-

pensate for the reduced braking effect by applying greater force to the brake pedal.

Notes on driving

⚠ WARNING Risk of accident due to objects in the driver's footwell

Objects in the driver's footwell may impede pedal travel or block a depressed pedal.

This jeopardizes the operating and road safety of the vehicle.

- ▶ Stow all objects in the vehicle securely so that they cannot get into the driver's footwell.
- ▶ Always install the floor mats securely and as prescribed in order to ensure that there is always sufficient room for the pedals.
- ▶ Do not use loose floor mats and do not place floor mats on top of one another.

⚠ WARNING Risk of accident due to unsuitable footwear

Operation of the pedals may be restricted due to unsuitable footwear such as:

- Shoes with platform soles
- Shoes with high heels
- Slippers

▶ When driving always wear suitable shoes in order to be able to operate the pedals safely.

⚠ WARNING Risk of accident when switching off the ignition when driving

If you switch off the ignition while driving, safety functions are restricted or no longer available. This may affect the power steering system and the brake force boosting, for example.

You will then need to use considerably more force to steer and brake.

▶ Do not switch off the ignition while driving.

⚠ DANGER Risk of fatal injuries due to exhaust gases

Combustion engines emit poisonous exhaust gases such as carbon monoxide. Inhaling these exhaust gases is hazardous to health and can lead to poisoning.

▶ Never leave the engine running in an enclosed space without sufficient ventilation.

⚠ WARNING Risk of skidding and of an accident due to shifting down on slippery road surfaces

If you shift down on slippery road surfaces to increase the engine braking effect, the drive wheels may lose traction.

▶ Do not shift down on slippery road surfaces to increase the engine braking effect.

⚠ DANGER Risk of fatal injury due to poisonous exhaust gases

If the tailpipe is blocked or sufficient ventilation is not possible, poisonous exhaust gases such as carbon monoxide may enter the vehicle. This is the case if the vehicle gets stuck in snow, for example.

- ▶ Keep the tailpipe and the area around the vehicle free from snow when the engine or the stationary heater are running.
- ▶ Open a window on the windward side of the vehicle to ensure an adequate supply of fresh air.

⚠ WARNING Risk of accident and injury due to being under the influence of alcohol and drugs while driving

Driving when under the influence of alcohol and/or drugs is an extremely dangerous combination. Even small quantities of alcohol or drugs may affect your reflexes, perception and judgment.

The probability of a serious or even fatal accident greatly increases if you drive when under the influence of alcohol or drugs.

- ▶ Do not drink alcohol or take drugs while driving, and do not allow anyone to drive who has been drinking alcohol or taking drugs.

⚠ WARNING Risk of accident due to the brake system overheating

If you leave your foot on the brake pedal when driving, the brake system may overheat.

This increases the braking distance and the brake system may even fail.

- ▶ Never use the brake pedal as a footrest.
- ▶ Do not depress the brake pedal and the accelerator pedal at the same time while driving.

! **NOTE** Wearing out the brake linings by continuously depressing the brake pedal

- ▶ Do not depress the brake pedal continuously whilst driving.
- ▶ To use the braking effect of the engine, shift to a lower gear in good time.

! **NOTE** Damage to the drivetrain and engine when pulling away

- ▶ Do not warm up the engine while the vehicle is stationary. Pull away immediately.
- ▶ Avoid high engine speeds and driving at full throttle until the engine has reached its operating temperature.

! **NOTE** Damage to the catalytic converter due to non-combusted fuel

The engine is not running smoothly and is misfiring.

Non-combusted fuel may get into the catalytic converter.

- ▶ Only depress the accelerator pedal slightly.
- ▶ Have the cause rectified immediately at a qualified specialist workshop.

Limited braking effect on salt-treated roads:

- Due to salt build-up on the brake discs and brakepads, the braking distance can increase considerably or result in braking only on one side
- Maintain a much greater safe distance to the vehicle in front

To prevent salt build-up:

- Brake occasionally while paying attention to the traffic conditions
- Carefully depress the brake pedal at the end of the journey and when starting the next journey

Notes on off-road driving

⚠ WARNING Risk of accident if you do not keep to line of fall on inclines

If you drive at an angle or turn on an incline, the vehicle could slip sideways, tip and roll-over.

- ▶ Always drive on inclines in the line of fall (straight up or down) and do not turn.

⚠ WARNING Risk of fire due to flammable materials on hot parts of the exhaust system

Flammable material such as leaves, grass or twigs may ignite if they come into contact with hot parts of the exhaust system.

- ▶ When driving on unpaved roads or off-road, regularly check the vehicle underside.
- ▶ Remove trapped plants or other flammable material.

- ▶ If there is damage, consult a qualified specialist workshop immediately.

When driving off-road, substances such as sand, mud and water or water mixed with oil may get into the brakes. This may lead to a reduction in braking effect or total brake failure as a result of increased wear. The braking characteristics will vary depending on the material that has entered the system. Clean the brakes after driving off-road. If you then notice reduced braking effect or hear scraping noises, have the brake system checked at a qualified specialist workshop. Adjust your driving style to the changed braking characteristics.

! NOTE Damage caused by driving over obstacles

The vehicle can be damaged by:

- Driving up on high curbs or unpaved roads.
- Quickly driving over obstacles such as curbs, speed bumps or potholes.

- Heavy objects hitting the underbody or chassis components.

- ▶ Do not drive over obstacles that could damage the vehicle.
- ▶ Check the vehicle regularly for damage during off-road driving.
- ▶ Adjust the vehicle speed to suit the road surface conditions.
- ▶ If there is damage, consult a qualified specialist workshop immediately.

🌿 ENVIRONMENTAL NOTE Environmental damage due to non-observance of prohibition signs

Environmental protection has priority. Treat nature with respect.

- ▶ Be sure to observe prohibition signs.

Checklist before driving off-road

Check the following points before driving off-road:

- Fuel level

- Engine oil level: fill engine oil up to the maximum level to ensure full gradeability (→ page 339).
- Tire-change tool kit and spare wheel
- Tires and wheels

Off-road driving

Read this section before driving your vehicle off-road. Practice by driving over more gentle off-road terrain first.

- Observe the notes on the cross-country ABS (→ page 159).
- Before driving off-road, shift the transfer case to the **LOW RANGE** off-road gear (→ page 144).
- Engage the differential locks if necessary (→ page 146).

In **LOW RANGE** off-road gear or with the differential locks engaged, the vehicle switches to **G-mode** (→ page 137).

In **LOW RANGE** off-road gear, you can shift from **D** to **R** and from **N** to **R** without having to depress the brake pedal. This can help you, for

example, when rocking your vehicle out of a rut ("rocking free").

- Always keep the engine running and in gear when driving on downhill gradients and slopes. Observe the notes on driving in mountainous terrain.
- Do not drive on unknown terrain that is not easily visible and stay on marked routes.
- Always keep the doors and windows closed while the vehicle is in motion.
- Deactivate Active Distance Assist DISTRONIC and cruise control.
- Adapt your driving style to the terrain.
- Do not use the HOLD function on steep downhill or uphill gradients with slippery or loose surfaces.

Driving on sand

When driving on sand, also observe the following instructions:

- Shift to a lower gear.
- Drive quickly to overcome the rolling resistance, otherwise the vehicle may dig itself in.

- Drive in the tracks of other vehicles if possible. Make sure that the following prerequisites are met:
 - the tire ruts are not too deep
 - the sand is firm enough
 - the ground clearance is sufficient
- Lower the tire pressure in all four wheels.

Contrary to the information on the tire pressure plate (fuel filler flap), you can lower the tire pressure to 120 kPa (1.2 bar/17.4 psi).

Mercedes-AMG vehicles: observe the notes in the Supplement. Otherwise, you may fail to recognize dangers.

- ⓘ Once you stop driving on sand, immediately increase the tire pressure again.

You can find information on tire pressure for the vehicle's factory-installed tires on the following labels:

- Tire and Loading Information placard on the B-pillar of your vehicle (→ page 377).
- Tire pressure table on the inside of the fuel filler flap (→ page 373).

Fording

Also observe the following information when fording:

- Drive at no more than 6 mph (10 km/h).
- Observe the maximum permissible fording depth (→ page 410).
- Switch off automatic climate control (→ page 123).
- Ensure that a bow wave does not form as you drive.
- Do not stop in the water and do not switch off the engine. Ensure the ECO start/stop function is switched off (→ page 134).

Driving in mountainous terrain

Also observe the following information when driving in mountainous terrain:

- Observe the values of the approach/departure angle and of the maximum gradient (→ page 410).
- Engage the differential locks if necessary (→ page 146).
- Avoid high engine speeds.

- Use the braking power of the engine when driving downhill.
- Shift to a lower gear on uphill gradients and on long, steep downhill gradients.

Checklist after driving off-road

Off-road driving terrain places greater demands on your vehicle than driving on normal roads. Check the entire vehicle for damage and foreign bodies every time after driving off-road. Foreign bodies in the wheels or drivetrain can lead to imbalances and therefore vibrations.

- Shift the transfer case to the on-road position **HIGH RANGE**.
- Disengage the differential locks.
- Apply the brakes to dry them after fording.
- Check that the service brake is working normally after a long downhill stretch.
- Clean the following components every time after driving off-road:
 - License plate number
 - headlamps and tail lamps
 - Tires, wheels and wheel arches

- Underbody
- After driving through sand, mud, water or gravel, have the following components checked and cleaned:
 - Brake discs and brakepads
 - Tires and wheels
 - Axle joints
 - Radiator

ECO start/stop function

Operation of the ECO start/stop function

Mercedes-AMG vehicles: observe the notes in the Supplement. Otherwise, you may fail to recognize dangers.

The engine is switched off automatically in the following situations if all vehicle conditions for an automatic engine stop are met:

- You brake the vehicle to a standstill in transmission position **D** or **N**.

if you switch on the HOLD function or select a different transmission position than **R**, the engine will automatically stop in the following situations:

- You stop behind a vehicle that is pulling away.
- You stop at a stop sign when there is no vehicle in front of you.
- You turn the steering wheel hard at a low speed.

The engine is restarted automatically if:

- You release the brake pedal in transmission position **D** when the HOLD function is not active.
- You engage transmission position **D** or **R**.
- You depress the accelerator pedal.
- You change the vehicle level.
- An automatic engine start is necessary.

If the engine was switched off by the ECO start/stop function and you leave the vehicle, a warning tone sounds and the engine is not restarted. The [Vehicle Operational Switch the Ignition Off](#)

Before Exiting display message also appears in the multifunction display. If you do not switch off the ignition, the ignition is automatically switched off after three minutes.

Deactivating or activating the ECO start/stop function

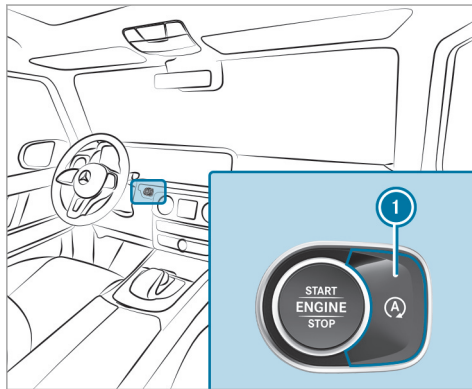

▶ Press button **1**.

A display appears in the instrument cluster when switching the ECO start/stop function off/on.

i A continuous display appears in the instrument cluster while the ECO start/stop function is deactivated.

ECO display function

The ECO display summarizes the driving characteristics from the start of the journey to its completion and assists you in achieving the most economical driving style.

You can influence consumption if you:

- Drive with particular care
- Drive the vehicle in drive program **E**.
- Observe the gearshift recommendations

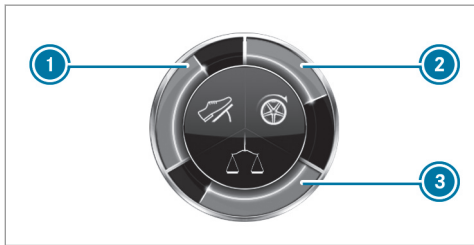

The inner segment lights up green and the outer segment fills up:

- ① Moderate acceleration
- ② Gentle deceleration and rolling
- ③ Consistent speed

The inner segment is gray and the outer segment empties:

- ① Sporty acceleration
- ② Heavy braking
- ③ Fluctuations in speed

You have driven economically when:

- The three outer segments are completely filled simultaneously
- The ECO display border lights up

The additional range achieved as a result of your driving style in comparison with a driver with a very sporty driving style is shown under **Bonus fr. Start**. The range displayed does not indicate a fixed reduction in consumption.

DYNAMIC SELECT switch

Function of the DYNAMIC SELECT switch

Mercedes-AMG vehicles: observe the notes in the Supplement. Otherwise, you may fail to recognize dangers.

Use the DYNAMIC SELECT switch to change between the following drive programs:

- **I (Individual):** individual settings
- **S (Sport):** sporty driving style
- **C (Comfort):** comfortable and economical driving style

- **E (Eco):** particularly economical driving style

The drive program **C (Comfort)** is automatically active after starting the vehicle.

Depending on the drive program selected, the following vehicle characteristics will change:

- Drive
 - Engine and transmission management
 - Active Distance Assist DISTRONIC
- ECO start/stop function
- ESP®
- Steering
- **Vehicles with adjustable damping:** Suspension

Selecting the drive program

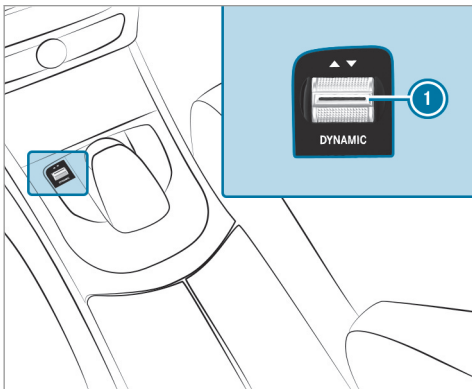

- ▶ Press DYNAMIC SELECT switch ① forwards or backwards. The selected drive program appears in the multifunction display in the instrument cluster and in the multimedia system display.

Selecting the Desert drive program

- ① The availability of the following function is country-dependent.
- ▶ Change to drive program **E (Eco)**.
- ▶ Press and hold DYNAMIC SELECT switch ① backwards for approx. three seconds. A visual and acoustic message is emitted.
- ▶ Confirm the selection with the left touchpad button on the steering wheel. The **Desert Drive Program Act. ESP Unavailable See Operator's Manual** message appears in the instrument cluster. The ESP[®] and ABS warning lamps light up.
- ① Observe the notes on the Desert ESP[®].
- ① A visual and acoustic message is emitted again when the driver's door is opened while the engine is running to draw attention to restricted road suitability in case of a change of drivers.
- ▶ Press DYNAMIC SELECT switch ① forwards to deactivate the Desert drive program.
- ① The drive program **C (Comfort)** is automatically active after starting the vehicle.

Configuring drive program I

Multimedia system:

- ↳ Vehicle ▶ DYNAMIC SELECT
- ▶ Individual
- ▶ Select the individual setting.

Switching the operation feedback for drive program on/off

Multimedia system:

- ↳ Vehicle ▶ DYNAMIC SELECT
- ▶ Switch **Notification for User** on or off . When this function is active, a corresponding message is shown in the media display when a drive program is selected with the DYNAMIC SELECT switch.

Displaying vehicle data

Multimedia system:

↳ Vehicle ▶  DYNAMIC SELECT

▶ Select Vehicle Data.

The following information is displayed:

- Compass
- Wheel angle
- Incline
- Gradient
- Altitude
- **LOW RANGE** (→ page 143)
- Locking (→ page 145)

Displaying engine data

Multimedia system:

↳ Vehicle ▶  DYNAMIC SELECT

▶ Select Engine Data.

- ① The values for engine output and engine torque may deviate from the nominal values.

Items that can influence this are, for example:

- Sea level
- Fuel grade
- Outside temperature

G-Mode

G-Mode is an additional drive program for off-road journeys and is not suitable for use on firm road surfaces. **G-Mode** is automatically activated, if one of the following conditions is met:

- You shift the transfer case to the **LOW RANGE** off-road gear (→ page 144).
- You engage at least one differential lock (→ page 146).

The **G** indicator appears in the instrument cluster.

G-Mode is automatically deactivated again, if the following conditions are met:

- You shift the transfer case to the on-road position **HIGH RANGE**.

- You disengage all differential locks.

Not all driving and driving safety systems are available in **G-Mode** under certain circumstances. Observe the system limits of the transfer case (→ page 143) and the differential locks (→ page 145).

It is not possible to change the drive program with the DYNAMIC SELECT switch in **G-Mode**. The DYNAMIC SELECT switch only works again when **G-Mode** has been deactivated.

Automatic transmission

DIRECT SELECT lever

Function of the DIRECT SELECT lever

⚠ WARNING Risk of accident and injury due to children left unattended in the vehicle

If children are left unattended in the vehicle, they could:

- open doors, thereby endangering other persons or road users.
- get out of the vehicle and be hit by oncoming traffic.
- operate vehicle equipment and become trapped, for example.

In addition, children could also set the vehicle in motion, for example, by:

- releasing the parking brake.
- shifting the automatic transmission out of park position **P**.
- starting the engine

- ▶ Never leave children and animals unattended in the vehicle.
- ▶ When leaving the vehicle, always take the SmartKey with you and lock the vehicle.
- ▶ Keep the SmartKey out of the reach of children.

⚠ WARNING Risk of accident due to incorrect gearshifting

If the engine speed is higher than the idle speed and you engage the transmission position **D** or **R**, the vehicle may accelerate sharply.

- ▶ If you engage the transmission position **D** or **R** always depress the brake pedal firmly and do not accelerate at the same time.

Use the DIRECT SELECT lever to shift the transmission position. The current transmission position is displayed in the multifunction display.

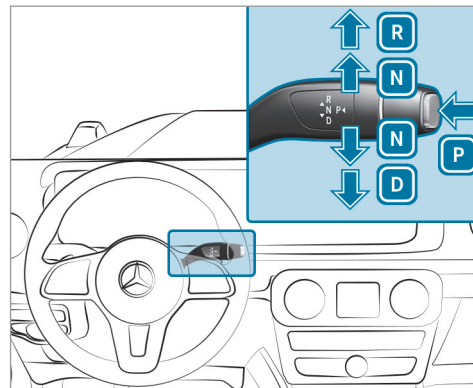

- P** Park position
- R** Reverse gear
- N** Neutral
- D** Drive position

Engaging reverse gear R

▶ Depress the brake pedal and push the DIRECT SELECT lever upwards past the first point of resistance.

The transmission position display shows **R** in the multifunction display.

i In **LOW RANGE** off-road gear, you can shift from **D** to **R** and from **N** to **R** without having to depress the brake pedal.

Engaging neutral N

▶ Depress the brake pedal and push the DIRECT SELECT lever up or down to the first point of resistance.

The transmission position display shows **N** in the multifunction display.

Subsequently releasing the brake pedal will allow you to move the vehicle freely, e.g. to push it or tow it away.

Proceed as follows if you want the automatic transmission to remain in neutral **N even if the ignition is switched off:**

▶ Start the vehicle.

▶ Depress the brake pedal and engage neutral **N**.

▶ Release the brake pedal.

▶ Switch the ignition off.

The **N Permanently Active Risk of Rolling Away** message appears in the instrument cluster.

i If you then exit the vehicle leaving the SmartKey in the vehicle, the automatic transmission remains in neutral **N**.

Engaging park position P

▶ Observe the notes on parking the vehicle (→ page 149).

▶ Depress the brake pedal until the vehicle is stationary.

▶ When the vehicle is stationary, press button **P**.

Park position is only engaged when the transmission position display **P** is shown in the multifunction display. If no transmission position display **P** appears, secure the vehicle to prevent it from rolling away.

i Depending on the situation, it may take some time until **P** is engaged. Therefore,

always pay attention to the transmission position display.

Park position **P** is engaged automatically if one of the following conditions is met:

- you switch off the ignition when the vehicle is stationary and the transmission is in position **D** or **R**.
- you open the driver's door when the vehicle is stationary or when driving at a very low speed and the transmission is in position **D** or **R**.

i To maneuver with an open driver's door, open the driver's door while stationary and engage transmission position **D** or **R** again.

Engaging drive position D

▶ Depress the brake pedal and push the DIRECT SELECT lever down past the first point of resistance.

The transmission position display shows **D** in the multifunction display.

When the automatic transmission is in transmission position **D**, it shifts the gears automatically. This depends on the following factors:

- the selected drive program
- the position of the accelerator pedal
- the driving speed

Manual gearshifting

⚠ WARNING Risk of skidding and of an accident due to shifting down on slippery road surfaces

If you shift down on slippery road surfaces to increase the engine braking effect, the drive wheels may lose traction.

- ▶ Do not shift down on slippery road surfaces to increase the engine braking effect.

Permanent setting

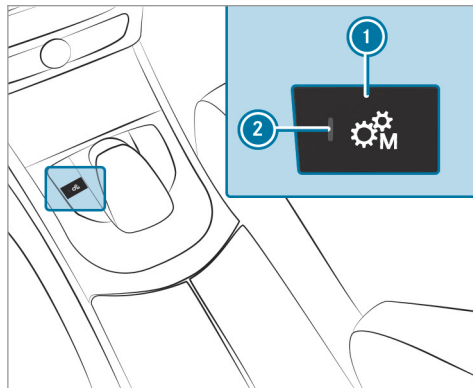

- ▶ **To activate/deactivate:** press button ①. If indicator lamp ② is lit, manual gearshifting is activated. The current gear is displayed in the multifunction display.

Temporary setting

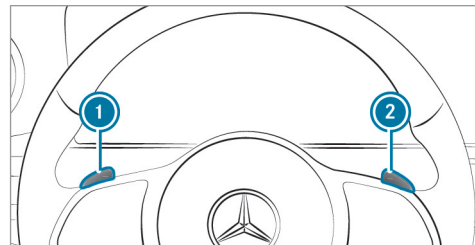

- ▶ **To activate:** pull steering wheel paddle shifter ① or ②. Manual gearshifting is activated for a short time. The current gear is displayed in the multifunction display.
 - ▶ **To deactivate:** pull steering wheel paddle shifter ② and hold it in place. The transmission position **D** appears in the multifunction display.
- ① To permanently shift the gears manually in drive program **I** using the steering wheel paddle shifters, select the **M** (Manual) setting for the transmission.

Gearshifting

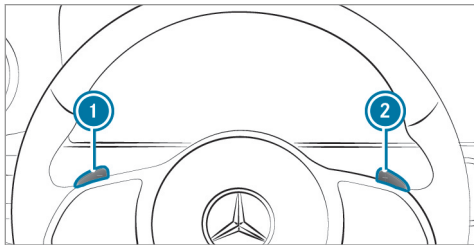

- ▶ **To shift up:** pull steering wheel paddle shifter ②.
- ▶ **To shift down:** pull steering wheel paddle shifter ①.

Mercedes-AMG vehicles: observe the notes in the Supplement. Otherwise, you may fail to recognize dangers.

Gearshift recommendation

Mercedes-AMG vehicles: observe the notes in the Supplement. Otherwise, you may fail to recognize dangers.

The gearshift recommendation assists you in adopting an economical driving style.

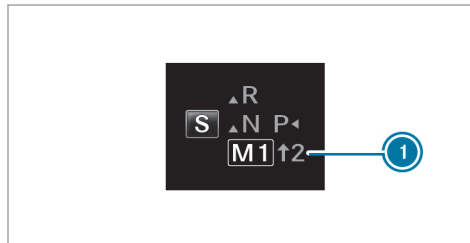

- ▶ If gearshift recommendation message ① is shown on the multifunction display, shift to the recommended gear.

Using kickdown

Mercedes-AMG vehicles: observe the notes in the Supplement. Otherwise, you may fail to recognize dangers.

- ▶ **Maximum acceleration:** depress the accelerator pedal beyond the pressure point.

The automatic transmission shifts up to the next gear when the maximum engine speed is reached to protect the engine from overrevving.

Glide mode function

Mercedes-AMG vehicles: observe the notes in the Supplement. Otherwise, you may fail to recognize dangers.

With an anticipatory driving style, glide mode helps you to reduce fuel consumption.

Glide mode is characterized by the following:

- the combustion engine is disconnected from the drivetrain and the engine continues to run in neutral.
- the transmission position **D** is displayed in green in the multifunction display.

Glide mode is activated if the following conditions are met:

- drive program **E** is selected.
- the speed is within a suitable range.
- the road's course is suitable, e.g. no steep uphill or downhill inclines or tight bends.

- there is no trailer coupled to the trailer hitch, and no bicycle rack installed.
- you are no longer depressing the accelerator or brake pedal.

i Glide mode can also be activated if you have selected the "Eco" setting for the drive in the drive program .

Glide mode is deactivated again if one of the conditions is no longer met.

Glide mode can also be prevented by the following parameters:

- Incline
- Downhill gradient
- Temperature
- Height
- Speed
- Operating status of the engine

- Traffic situation

i Glide mode can be ended by pressing the right-hand steering wheel paddle shifter (→ page 140).

Problems with the transmission

Problem	Possible causes/consequences and ► Solutions
The transmission has a faulty gearshift.	<p>The transmission is losing oil.</p> <ul style="list-style-type: none"> ► Have the transmission checked at a qualified specialist workshop immediately.
<p>The acceleration characteristics are deteriorating.</p> <p>The transmission no longer shifts gear.</p>	<p>The transmission is in emergency operation mode. It is only possible to shift to one gear and reverse gear.</p> <ul style="list-style-type: none"> ► Pull over and stop the vehicle safely as soon as possible, paying attention to road and traffic conditions. ► Switch the transmission to position . ► Switch off the engine. ► Wait at least ten seconds before restarting the engine.

Problem**Possible causes/consequences and ► Solutions**

- Shift the transmission to position **D** or **R**.
If **D** is selected, the transmission only shifts to one gear; if **R** is selected, the transmission shifts to reverse gear.
- Have the transmission checked at a qualified specialist workshop immediately.

Transfer case**Function of the transfer case**

⚠ WARNING Risk of skidding and having an accident when in **LOW RANGE** on slippery road surfaces

If you select the **LOW RANGE** off-road gear on a slippery road surface, the wheels could lose traction in the following situations:

- If you release the accelerator pedal when the vehicle is in motion.
- If off-road ABS intervenes when braking.

If the wheels lose traction, it will no longer be possible to steer the vehicle.

- Never select the **LOW RANGE** off-road gear when driving on slippery road surfaces.

Shift the transfer case to the on-road position **HIGH RANGE** or into the **LOW RANGE** off-road gear.

Shift ranges

HIGH RANGE	LOW RANGE
Road position for all normal on-road driving situations.	Off-road gear for driving off-road, when fording and on steep uphill or downhill inclines.

Properties of the **LOW RANGE** off-road gear:

- Reduced maximum speed and increased tractive power
- The transmission ratio changes by approximately a factor of three.
- Increased drive torque

Do not use **LOW RANGE** in the following situations:

- When driving on public roads.

Shifting the transfer case

Shifting to the LOW RANGE off-road gear

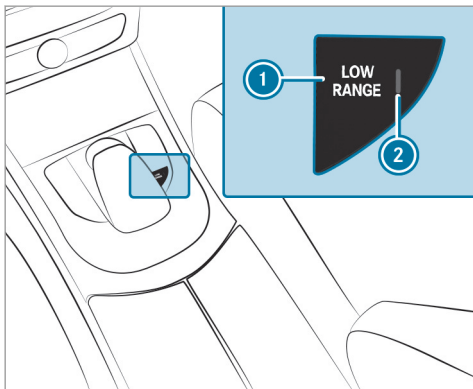

Requirements:

- You are not driving on a paved or public road.
- The engine is running and you are not driving faster than 25 mph (40 km/h).
- The transmission is in position **N**.

- ▶ Press **LOW RANGE** ① button. Indicator lamp ② flashes. The shift request stays active for a maximum 30 seconds. If all requirements for shift operation are not fulfilled within this time, indicator lamp ② switches off again and the shift operation must be started again.
- ▶ Switch the transmission to position **N**. If shift operation is successful, the **LOW RANGE On** message appears in the instrument cluster, an audible signal sounds and indicator lamp ② lights up continuously. The vehicle changes automatically to the **G-Mode** drive program.
- ▶ Shift the transmission to position **D**.
- ⓘ The vehicle stays in LOW RANGE if you park the vehicle in LOW RANGE, even after the engine has been restarted. The G-Mode drive program continues to be active (→ page 137).

In the on-road position, shift to HIGH RANGE

Requirements:

- The engine is running and you are not driving faster than 43 mph (70 km/h).
 -
 - The transmission is in position **N**.
- ▶ Press **LOW RANGE** ① button. The shift request stays active for a maximum 30 seconds. If all requirements for shift operation have not been fulfilled within this time, shift operation must be started again.
 - ▶ Shift the transmission to position **N**. If shift operation is successful, the **LOW RANGE Off** message appears in the instrument cluster, an audible signal sounds and indicator lamp ② goes out.
 - ▶ Shift the transmission to position **D**.

Differential locks

Function of the differential lock

⚠ WARNING Risk of accident when differential lock is disengaged on a firm surface

If you engage differential locks when driving on a firm, high-traction surface, the steerability of the vehicle is severely restricted. You could lose control of the vehicle, especially when engaging on a bend.

▶ Always disengage the differential locks immediately on a firm, high-traction surface.

⚠ WARNING Risk of accident due to deactivated driving safety systems

When the differential locks are engaged, ABS, 4ETS, ESP[®] and BAS are deactivated. Because of this, the wheels can lock while braking and the braking distance is increased.

▶ Always disengage the differential locks immediately on a firm, high-traction surface.

Differential locks improve the traction of the vehicle when driving off-road and fording.

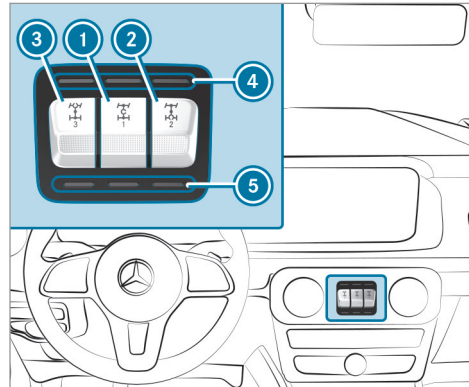

The vehicle has three differential locks:

- The differential lock for transfer case **①** disables the rotational speed compensation between the front and rear axles.
- The differential lock for rear axle **②** disables the rotational speed compensation between the wheels of the rear axle.
- The differential lock for the front axle **③** disables the rotational speed compensation between the wheels of the front axle.

System limitations

If the differential locks are engaged, the following driving and driving safety systems are deactivated:

- ABS (→ page 159)
- Active Distance Assist DISTRONIC (→ page 167)
- Active Brake Assist
- Active Parking Assist (→ page 184)
- Active Lane Keeping Assist (→ page 195)
- BAS (→ page 160)
- Hill Start Assist (→ page 171)

- ECO start/stop function (→ page 133)
- ESP® (→ page 160)
- HOLD function (→ page 171)
- Limiter
- Cruise control (→ page 165)
- Blind Spot Assist (→ page 193)

Engaging/disengaging the differential locks

Engaging the differential locks



Requirements:

- You are not driving on a paved or public road.
- You are driving at walking pace.
- The driven wheels are not spinning.
- The transfer case is shifted to the **LOW RANGE** off-road gear (→ page 144).

▶ Engage in the order ①, ②, ③. Press the respective buttons to do this. Only engage differential locks ② and ③ for the front and rear axle if required.

If all conditions have been fulfilled, activation indicator lamps ⑤ light up. As soon as the differential locks are active, function indicator lamps ④ light up.

The **Differential Lock Engaged ABS and ESP**

Unavailable message and the    warning and indicator lamps on the instrument cluster appear.

ⓘ If one or more requirements have not been fulfilled, the **Differential Lock Activation Conditions Not Fulfilled** message appears. If the transfer case is not in **LOW RANGE**, the message **Differential Locks Available Only in LOW RANGE** appears when you switch it on. The gear change must be restarted.

Disengaging the differential locks

▶ Press the buttons in the order ③, ②, ①.

or

▶ To simultaneously disengage all differential locks: press button ①.

or

▶ To disengage the differential locks for the rear and front axles: press button ②.

The differential locks are only disengaged when the function indicator lamps have gone out again ④.

If you park the vehicle with the differential locks engaged, they will be deactivated automatically when the vehicle is started again. In some cases, you have to drive a few meters before the differential locks are properly disengaged. Therefore, check if function indicator lamps ④ are off when you restart the vehicle.

Observe any information which may be displayed in the instrument cluster:

- Warning and indicator lamps
- Display messages

Function of the 4MATIC

4MATIC ensures that all four wheels are driven when needed. Together with ESP® and 4ETS, 4MATIC improves the traction of your vehicle whenever a driven wheel spins due to insufficient traction.

If you fail to adapt your driving style, 4MATIC can neither reduce the risk of an accident nor override the laws of physics. 4MATIC cannot take account of road, weather and traffic conditions. 4MATIC is only an aid. You are responsible especially for maintaining a safe distance from the vehicle in front, for vehicle speed, for braking in good time and for staying in lane.

- ❗ In wintry road conditions, the maximum effect of 4MATIC can be achieved only if you use winter tires (M+S tires), with snow chains if necessary.

Refueling

Refueling the vehicle

⚠ WARNING Risk of fire or explosion from fuel

Fuels are highly flammable.

- ▶ Fire, open flames, smoking and creation of sparks must be avoided.

- ▶ Switch off the ignition and, if available, the stationary heater, before and while refueling the vehicle.

⚠ WARNING Risk of injury from fuels

Fuels are poisonous and hazardous to your health.

- ▶ Do not swallow fuel or let it come into contact with skin, eyes or clothing.
- ▶ Do not inhale fuel vapor.
- ▶ Keep children away from fuel.
- ▶ Keep doors and windows closed during the refueling process.

If you or other people come into contact with fuel, observe the following:

- ▶ Immediately rinse fuel off your skin with soap and water.
- ▶ If fuel comes into contact with your eyes, immediately rinse them thoroughly with clean water. Seek medical attention immediately.

- ▶ If you swallow fuel, seek medical attention immediately. Do not induce vomiting.
- ▶ Change immediately out of clothing that has come into contact with fuel.

⚠ WARNING Risk of fire or explosion from electrostatic charge

Electrostatic charge can create sparks and thereby ignite fuel vapors.

- ▶ Before you open the fuel filler cap or take hold of the pump nozzle, touch the metallic vehicle body. This discharges any electrostatic charge that may have built up.
- ▶ Do not get into the vehicle again during the refueling process. Otherwise, electrostatic charge could build up again.

! NOTE Damage caused by the wrong fuel

Vehicles with a gasoline engine:

Even small amounts of the wrong fuel could result in damage to the fuel system, the engine and the emission control system.

- ▶ The RON requirement is located in the fuel filler flap.
- ▶ Only refuel with low-sulfur unleaded fuel.

This fuel may contain up to 10% ethanol. Your vehicle is suitable for use with E10 fuel.

Never refuel using any of the following fuels:

- Diesel
- Gasoline with more than 10% ethanol by volume, e.g. E15, E85, E100
- Gasoline with more than 3% methanol by volume, e.g. M15, M30, M85, M100
- Gasoline with additives containing metal

If you accidentally refuel with the wrong fuel:

- ▶ Do not switch the ignition on.
- ▶ Consult a qualified specialist workshop.

! **NOTE** Do not use diesel to refuel vehicles with a gasoline engine.

If you accidentally refuel with the wrong fuel:

- Do not switch the ignition on. Otherwise fuel can enter the engine.

Even small amounts of the wrong fuel could result in damage to the fuel system and the engine. The repair costs are high.

- ▶ Consult a qualified specialist workshop.
- ▶ Have the fuel tank and fuel lines drained completely.

! **NOTE** Fuel may spray out when you remove the fuel pump nozzle.

- ▶ Only fill the fuel tank until the pump nozzle switches off.

Requirements:

- The vehicle is unlocked.
- i** Do not get into the vehicle again during the refueling process. Otherwise, electrostatic charge could build up again.

Observe the notes on operating fluids (→ page 402).

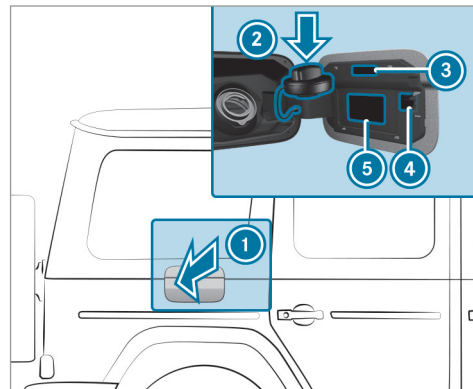

- ① Fuel filler flap
- ② Fuel filler cap
- ③ Fuel type
- ④ Tire pressure table
- ⑤ QR code for rescue card

- ▶ Press on the back area of fuel filler flap ①.
- ▶ Turn the fuel filler cap counter-clockwise and remove it.
- ▶ Completely insert the pump nozzle into the tank filler neck, hook in place and refuel.
- ▶ Only fill the tank until the pump nozzle switches off.
- ▶ Replace the cap on the filler neck and turn clockwise until it engages audibly.
- ▶ Close the fuel filler flap.

Parking

Parking the vehicle

⚠ WARNING Risk of accident and injury caused by an insufficiently secured vehicle rolling away.

If the vehicle is not securely parked sufficiently, it can roll away in an uncontrolled way even at a slight downhill gradient.

- ▶ Ensure that the parked vehicle is always properly secured against rolling away as follows:
 - On uphill or downhill gradients, turn the front wheels so that the vehicle rolls towards the curb if it starts moving.
 - Apply the parking brake.
 - Switch the transmission to position **P**.

⚠ WARNING Risk of fire caused by hot exhaust system parts

Flammable material such as leaves, grass or twigs may ignite if they come into contact with hot parts of the exhaust system or exhaust gas flow.

- ▶ Park the vehicle so that no flammable material can come into contact with hot vehicle components.
- ▶ In particular, do not park on dry grass-land or harvested grain fields.

⚠ WARNING Risk of accident and injury due to children and animals left unattended in the vehicle

If you leave children and animals unattended in the vehicle, they may be able to set the vehicle in motion, for example by:

- Releasing the parking brake.
- Shifting the automatic transmission out of park position **P**.
- Starting the engine.

In addition, they may operate vehicle equipment and become trapped.

- ▶ Never leave children and animals unattended in the vehicle.
- ▶ When leaving the vehicle, always take the SmartKey with you and lock the vehicle.

! **NOTE** Damage to the vehicle due to it rolling away

▶ Always secure the vehicle against rolling away.

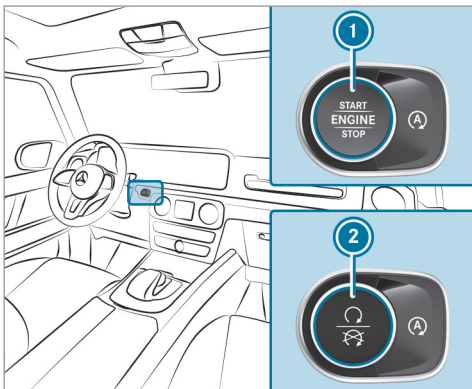

▶ Bring the vehicle to a standstill by applying the brake pedal.

- ▶ On uphill or downhill gradients, turn the front wheels so that the vehicle rolls towards the curb if it starts moving.
 - ▶ Apply the electric parking brake.
 - ▶ Engage transmission position **P** in a stationary vehicle with the brake pedal applied (→ page 139).
 - ▶ Switch off the engine and the ignition by pressing button ① or ②.
 - ▶ Release the service brake slowly.
 - ▶ Get out of the vehicle and lock it.
- ① When you park the vehicle with the transfer case in position **LOW RANGE**, the electric parking brake (→ page 155) is automatically applied when engaging transmission position **P**.
- ② When you park the vehicle, you can still operate the side windows and the sliding sunroof for approximately five minutes if the driver's door is closed.

Garage door opener

Programming buttons for the garage door opener

! **DANGER** Risk of fatal injuries due to exhaust gases

Combustion engines emit poisonous exhaust gases such as carbon monoxide. Inhaling these exhaust gases is hazardous to health and can lead to poisoning.

▶ Never leave the engine running in an enclosed space without sufficient ventilation.

! **WARNING** Risk of injury when opening or closing a door with the garage door opener

When you operate or program the door with the integrated garage door opener, people in the range of movement of the door may become trapped or struck by the door.

▶ When using the integrated garage door opener, always make sure that nobody

is within the range of movement of the door.

Only operate the following doors using the garage door opener:

- Doors with a safety stop and reversing feature.
- Doors which conform to the current U.S. safety standards.

Requirements:

- The vehicle has been parked outside the garage or outside the range of movement of the door.
 - The engine is switched off.
 - The ignition is switched on.
- i** The garage door opener function is always available when the ignition is switched on.

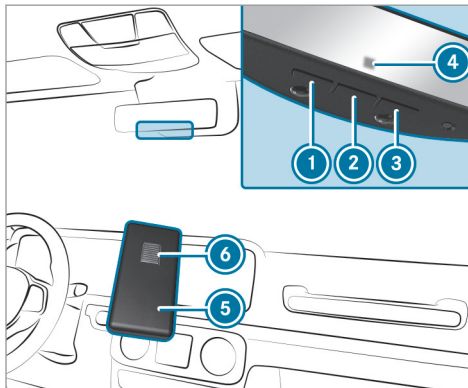

- ▶ Check if the transmitter frequency of the remote control has the frequency range of 280 to 868 MHz.

Radio equipment approval number:

- NZLMUAHL5 (USA)
- 4112A-MUAHL5 (Canada)

- ▶ Press and hold button ①, ② or ③ that you wish to program. Indicator lamp ④ flashes yellow.

- i** It can take up to 20 seconds before the indicator lamp flashes yellow.

- ▶ Release the previously pressed button. Indicator lamp ④ continues to flash yellow.

- ▶ Point remote control ⑤ from a distance of 1 in (1 cm) to 3 in (8 cm) towards buttons ①, ② or ③.

- ▶ Press and hold button ⑥ of remote control ⑤ until one of the following signals appears:
 - Indicator lamp ④ lights up green continuously. Programming is complete.
 - Indicator lamp ④ flashes green. Programming was successful. Additionally, synchronization of the rolling code with the door system must also be carried out.

- ▶ If indicator lamp ④ does not light up or flash green: repeat the procedure.

- ▶ Release all of the buttons.

- ⓘ The remote control for the door drive is not included in the scope of delivery of the garage door opener.

Synchronizing the rolling code

Requirements:

- The door system uses a rolling code.
- The vehicle must be within range of the garage door or door drive.
- The vehicle as well as persons and objects, are located outside the range of movement of the door.

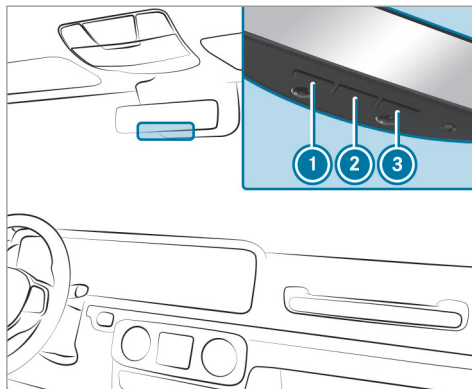

- ▶ Press the programming button on the door drive unit. Initiate the next step within approximately 30 seconds.
- ▶ Press previously programmed button ①, ② or ③ repeatedly until the door closes. When the door closes, programming is completed.

- ⓘ Please also read the operating instructions for the door drive.

Troubleshooting when programming the remote control

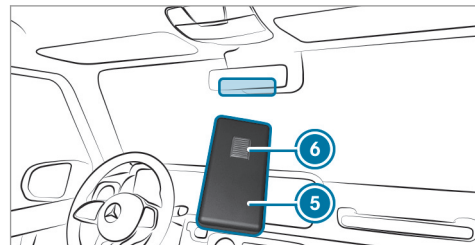

- ▶ Check if the transmitter frequency of remote control ⑤ is supported.
- ▶ Replace the batteries in remote control ⑤.
- ▶ Hold remote control ⑤ at various angles at a distance between 1 in (1 cm) to 3 in (8 cm) in front of the inside rearview mirror. You should test every position for at least 25 seconds before trying another position.

- ▶ Hold remote control ⑤ at the same angles at various distances in front of the inside rearview mirror. You should test every position for at least 25 seconds before trying another position.
- ▶ Note that some remote controls transmit only for a limited period, press button ⑥ on remote control ⑤ again before transmission ends.
- ▶ Align the antenna line of the door opener unit with the remote control.

① Support and additional information on programming:

- On the toll free HomeLink® Hotline on 1-800-355-3515.
- On the Internet at <http://www.homelink.com/mercedes>.

Opening/closing a garage door

Requirements:

- The corresponding button is programmed to operate the door.

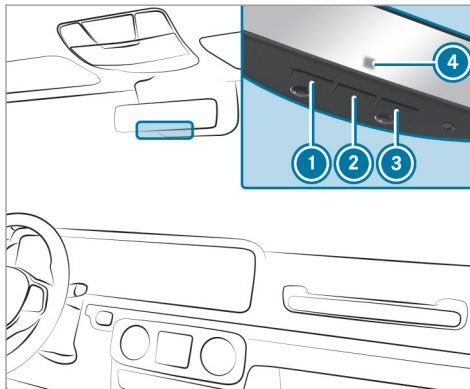

- ▶ Press and hold buttons ①, ② or ③ until the door opens or closes.
- ▶ If indicator lamp ④ flashes yellow after approximately 20 seconds: press and hold the previously pressed button again until the door opens or closes.

Clearing the garage door opener memory

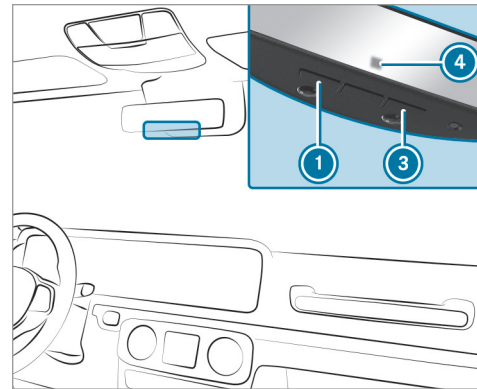

- ▶ Press and hold buttons ① and ③. Indicator lamp ④ lights up yellow.
- ▶ If indicator lamp ④ flashes green: release buttons ① and ③. The entire memory has been deleted.

Radio equipment approval numbers for the garage door opener

Radio equipment approval numbers



Brazil

Este equipamento opera em caráter secundário, isto é, não tem direito à proteção contra interferência prejudicial, mesmo de estações do mesmo tipo, e não pode causar interferência a sistemas operando em caráter primário.

Para maiores informações acessar www.anatel.gov.br

Radio equipment approval numbers

Country	Radio equipment approval number
Egypt	TAC.2511151293.WIR
Andorra	CE
Australia	R-NZ
Barbados	MED1578
Chile	2488/DFRS20576/F-74
European Union	CE
Gibraltar	CE
Iceland	CE
Jordan	TRC/LPD/2015/299
Canada	IC: 4112A-MUAHL5
Kuwait	CE
Liechtenstein	CE

Country	Radio equipment approval number
Mexico	RCPGEMU15-0448
Monaco	CE
New Zealand	R-NZ
Norway	CE
Russian Federation	Not required
Saudi Arabia	TA 10525
Switzerland	CE
South Africa	 TA-2015/1386

Country	Radio equipment approval number
Turkey	Not required
United Arab Emirates	ER41849/15 Dealer No: DA35176/14
United States	FCC ID: NZLMUAHL5

Further information on the declaration of conformity for wireless vehicle components (→ page 23).

Electric parking brake

Electric parking brake function (applying automatically)

⚠ WARNING Risk of accident and injury due to children and animals left unattended in the vehicle

If you leave children and animals unattended in the vehicle, they may be able to set the vehicle in motion, for example by:

- Releasing the parking brake.
- Shifting the automatic transmission out of park position **P**.
- Starting the engine.

In addition, they may operate vehicle equipment and become trapped.

- ▶ Never leave children and animals unattended in the vehicle.
- ▶ When leaving the vehicle, always take the SmartKey with you and lock the vehicle.

The electric parking brake is applied if the transmission is in position **P** and one of the following conditions is fulfilled:

- The engine is switched off.
 - The seat belt tongue is not inserted in the seat belt buckle of the driver's seat and the driver's door is opened.
 - The transfer case is in the **LOW RANGE** position.
- i** To prevent application: pull the handle of the electric parking brake.

In the following situations, the electric parking brake is also applied:

- Active Distance Assist DISTRONIC is bringing the vehicle to a standstill.
- The HOLD function is keeping the vehicle stationary.
- Active Parking Assist is keeping the vehicle stationary.

This is the case if one of the following conditions is also fulfilled:

- The engine is switched off.

- The seat belt tongue is not inserted in the seat belt buckle of the driver's seat and the driver's door is opened.
- There is a system malfunction.
- The power supply is insufficient.
- The vehicle is stationary for a lengthy period.

When the electric parking brake is applied, the red **PARK** (USA) or **(P)** (Canada) indicator lamp appears in the instrument cluster.

The electric parking brake is not automatically applied if the engine is switched off by the ECO start/stop function.

Electric parking brake function (releasing automatically)

The electric parking brake is released when the following conditions are fulfilled:

- The engine is running.
- The seat belt tongue is inserted into the seat belt buckle of the driver's seat.
- The transmission is in position **D** or **R** and you depress the accelerator pedal or you

shift from transmission position **P** to **D** or **R**.

If the seat belt tongue is not inserted into the seat belt buckle of the driver's seat, the following conditions must be fulfilled:

- The driver's door is closed.
- You move the transmission out of transmission position **P** or you have previously driven faster than 2 mph (3 km/h).

When the electric parking brake is released, the red **PARK** (USA) or **(P)** (Canada) indicator lamp in the instrument cluster goes out.

Applying/releasing the electric parking brake manually

Applying

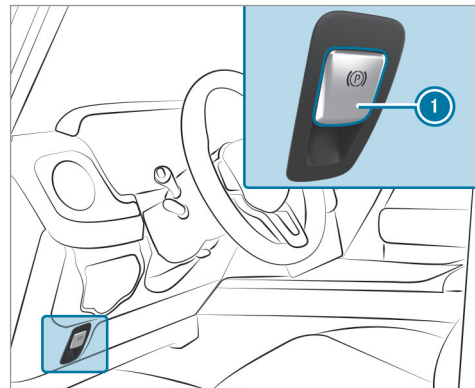

▶ Push handle ①.

The red **PARK** (USA) or **(P)** (Canada) indicator lamp appears in the instrument cluster.

- i** The electric parking brake is only securely applied if the indicator lamp is lit continuously.

Releasing

- ▶ Switch on the ignition.
- ▶ Pull handle **1**.
The red **PARK** (USA) or **(P)** (Canada) indicator lamp in the instrument cluster goes out.

Emergency braking

- ▶ Press and hold handle **1**.
When the vehicle has been braked to a standstill, the electric parking brake is applied. The red **PARK** (USA) or **(P)** (Canada) indicator lamp appears in the instrument cluster.

Information on detecting damage on a parked vehicle

If a collision is detected when the tow-away alarm is armed on a locked vehicle, you will receive a notification in the multimedia system when you switch on the ignition.

You will receive information about the following points:

- The area of the vehicle that may have been damaged.
- The force of the impact.

The following situations can lead to inadvertent activation:

- The parked vehicle is moved, e.g. in a two-story garage.
- i** Deactivate the tow-away alarm in order to prevent inadvertent activation. If you deactivate the tow-away alarm, damage detection will also be deactivated.

System limitations

Detection may be restricted in the following situations:

- The vehicle is damaged without impact, e.g. if an outside mirror is torn off or the paint is damaged by a key.
- Impact occurs at low speed.
- The electric parking brake is not applied.

Notes on parking the vehicle for an extended period

If you leave the vehicle parked for longer than four weeks, the disconnected battery may be damaged by deep discharge.

If you leave the vehicle parked for longer than six weeks, it may suffer disuse damage.

- i** Further information can be obtained at a qualified specialist workshop.

Standby mode (extension of the starter battery's period out of use)

Standby mode function

- i** This function is not available for all models. If standby mode is activated, the vehicle can be parked for an extended period of time without losing power.

Standby mode is characterized by the following:

- The starter battery is preserved.
- The maximum non-operational time out of use is displayed in the multimedia system display.

- The connection to online services is interrupted.

If the following conditions are fulfilled, standby mode can be activated or deactivated using the multimedia system:

- The engine is switched off.
- The ignition is switched on.

Exceeding the vehicle's displayed non-operational time may cause inconvenience, i.e. it cannot be guaranteed that the starter battery will reliably start the engine.

The starter battery must be charged first in the following situations:

- The vehicle's non-operational time must be extended.
- The **Battery Charge Insufficient for Standby Mode** message appears in the multimedia system display.

i Standby mode is automatically deactivated when the ignition is switched on.

Activating/deactivating standby mode

Multimedia system:

↳ **Vehicle** ▶  **Vehicle Settings**

▶ **Standby Mode**

i This function is not available for all models.

- ▶ Activate or deactivate the function. When you activate the function, a prompt appears.
- ▶ Select **Yes**. Standby mode is activated.

Driving and driving safety systems

Driving systems and your responsibility

Your vehicle is equipped with driving systems which assist you in driving, parking and maneuvering the vehicle. The driving systems are aids and do not relieve you of your responsibility pertaining to road traffic law. Pay attention to the traffic conditions at all times and intervene when necessary. Be aware of the limitations regarding the safe use of these systems.

Function of the radar sensors

Some driving and driving safety systems use radar sensors to monitor the area in front of, behind or next to the vehicle (depending on the vehicle's equipment).

Depending on the vehicle's equipment, the radar sensors are integrated behind the bumpers and/or behind the Mercedes star. Keep these parts free of dirt, ice and slush (→ page 348). The sensors must not be covered, for example by cycle racks, overhanging loads, stickers, foil or foils to protect against stone chipping. In the event of damage to the bumpers or radiator grill, or following a collision impacting the bumpers or radiator grill, have the function of the radar sensors checked at a qualified specialist workshop. The driver assistance system may no longer work properly.

Overview of driving systems and driving safety systems

In this section, you will find information about the following driving systems and driving safety systems:

- 360° Camera (→ page 180)
- ABS (**A**nti-**l**ock **B**raking **S**ystem) (→ page 159)
- Active Distance Assist DISTRONIC (→ page 167)
- Active Brake Assist
- Active Lane Keeping Assist (→ page 195)
- ATTENTION ASSIST (→ page 190)
- BAS (**B**rake **A**ssist **S**ystem) (→ page 160)
- Hill Start Assist (→ page 171)
- EBD (**E**lectronic **B**rakeforce **D**istribution) (→ page 162)
- ESP® (**E**lectronic **S**tability **P**rogram) (→ page 160)
- Active Speed Limit Assist
- HOLD function (→ page 171)

- Active Parking Assist (→ page 184)
- Parking Assist PARKTRONIC (→ page 174)
- Rear view camera (→ page 178)
- Cruise control (→ page 165)
- Blind Spot Assist (→ page 193)
- Traffic Sign Assist (→ page 191)
- Damping adjustment (→ page 172)

Functions of ABS (Anti-lock Braking System)

ABS regulates the brake pressure in critical driving situations:

- During braking, e.g. at full brake application or insufficient tire traction, the wheels are prevented from locking.
- Vehicle steerability while braking is ensured.

If ABS intervenes when braking, you will feel a pulsing in the brake pedal. The pulsating brake pedal can be an indication of hazardous road conditions and can serve as a reminder to take extra care while driving.

System limitations

- ABS is active from speeds of approx. 3 mph (5 km/h).
- ABS may be impaired or may not function if a malfunction has occurred and the yellow  ABS warning lamp lights up continuously in the instrument cluster after the engine is started.

Functions of Off-road ABS

Off-road ABS is specially adapted for driving off-road:

- The front wheels lock cyclically during braking
- The braking distance is shortened due to the digging-in effect

System limitations

- Off-road ABS functions at speeds below 37 mph (60 km/h)
- If Off-road ABS intervenes, the ability to steer may be restricted

Function of BAS (Brake Assist System)

⚠ WARNING Risk of an accident caused by a malfunction in BAS (Brake Assist System)

If BAS is malfunctioning, the braking distance in an emergency braking situation is increased.

▶ Depress the brake pedal with full force in emergency braking situations. ABS prevents the wheels from locking.

BAS supports your emergency braking situation with additional brake force.

If you depress the brake pedal quickly, BAS is activated:

- BAS automatically boosts the brake pressure.
- BAS can shorten the braking distance.
- ABS prevents the wheels from locking.

The brakes will function as usual once you release the brake pedal. BAS is deactivated.

Functions of ESP® (Electronic Stability Program)

⚠ WARNING Risk of skidding if ESP® is malfunctioning

If ESP® is malfunctioning, ESP® cannot carry out vehicle stabilization. In addition, other driving safety systems are switched off.

- ▶ Drive on carefully.
- ▶ Have ESP® checked at a qualified specialist workshop.

⚠ WARNING Risk of skidding if ESP® is deactivated

If you deactivate ESP®, ESP® cannot carry out vehicle stabilization.

- ▶ ESP® should only be deactivated in the following situations.

Mercedes-AMG vehicles: always observe the notes in the Supplement. Otherwise, you may fail to recognize dangers.

ESP® can monitor and improve driving stability and traction in the following situations, within physical limits:

- When pulling away on a wet or slippery roadway.
- When braking.
- **Vehicles with trailer hitch:** In trailer operation from speeds of 40 mph (65 km/h), if the vehicle/trailer combination begins to sway from side to side.

If the vehicle deviates from the direction desired by the driver, ESP® can stabilize the vehicle by intervening in the following ways:

- One or more wheels are braked.
- The engine output is adapted according to the situation.

ESP® is deactivated if the  ESP® OFF warning lamp lights up continuously in the instrument cluster.

Observe the following points when ESP® is deactivated:

- Driving stability will no longer be improved.

- **Vehicles with trailer hitch:** Stabilization of the vehicle/trailer combination is no longer active.
 - The drive wheels could spin.
 - ETS/4ETS traction control is still active.
- ❗ When ESP® is deactivated, you are still assisted by ESP® when braking.

If the  ESP® warning lamp flashes in the instrument cluster, one or several vehicle wheels has reached its grip limit:

- Adapt the driving style to suit the prevailing road and weather conditions.
- Do not deactivate ESP® under any circumstances.
- Only depress the accelerator pedal as far as is necessary.

It may be best to deactivate ESP® in the following situations:

- When using snow chains.
- In deep snow.
- On sand or gravel.

- ❗ Spinning the wheels results in a cutting action, which enhances traction.

If the  ESP® warning lamp lights up continuously, ESP® is not available due to a malfunction.

Observe the following information:

- Warning and indicator lamps (→ page 458)
- Display messages (→ page 413)

ETS/4ETS (Electronic Traction System)



ETS/4ETS traction control is part of ESP® and makes it possible to pull away and accelerate on a slippery roadway.

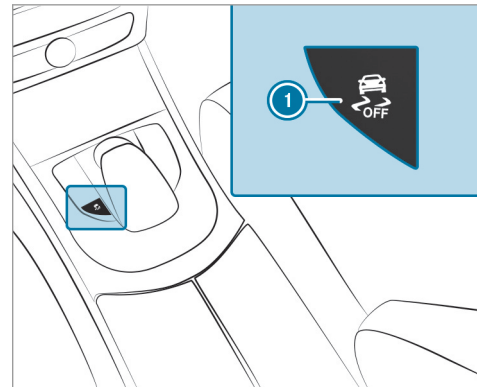

ETS/4ETS can improve the vehicle's traction by intervening in the following ways:

- The drive wheels are braked individually if they spin.
- More drive torque is transferred to the wheel or wheels with traction.

Activating/deactivating ESP® (Electronic Stability Program)



- ▶ **To deactivate ESP®:** press button ❶ until the  ESP® OFF warning lamp lights up in the instrument cluster. The  OFF message appears in the multifunction display.

- ▶ **To activate ESP®:** briefly press button . The  ESP® OFF warning lamp in the instrument cluster goes out.

Observe the information on warning lamps and display messages which may be shown in the instrument cluster.

Function of ESP® trailer stabilization

⚠ WARNING Risk of accident in poor road and weather conditions

In poor road and weather conditions, the trailer stabilization cannot prevent lurching of the vehicle/trailer combination. Trailers with a high center of gravity may tip over before ESP® detects this.

- ▶ Always adapt your driving style to suit the current road and weather conditions.

When driving with a trailer, ESP® can stabilize your vehicle if the trailer begins to swerve from side to side:

- ESP® trailer stabilization is active above speeds of 40 mph (65 km/h).
- Slight swerving is reduced by means of a targeted, individual brake application on one side.
- In the event of severe swerving, the engine output is also reduced and all wheels are braked.

ESP® trailer stabilization may be impaired or may not function if:

- The trailer is not connected correctly or is not detected properly by the vehicle.

Function of EBD (electronic brake force distribution)

EBD is characterized by the following:

- Monitoring and regulating the brake pressure on the rear wheels.

- Improved driving stability when braking, especially on bends.

Function of Active Brake Assist

Active Brake Assist consists of:

- Distance warning function
- Autonomous braking function
- Situation-dependent braking assistance

Active Brake Assist can help you to minimize the risk of a collision with vehicles, cyclists or pedestrians, or reduce the effects of such a collision.

If Active Brake Assist has detected a risk of collision, a warning tone sounds and the  distance warning lamp lights up in the instrument cluster.

If you do not react to the visual or acoustic warning, autonomous braking can be initiated in critical situations.

In especially critical situations, Active Brake Assist can initiate autonomous braking directly. In this case, the warning lamp and warning tone

occur simultaneously with the braking application.

If you apply the brake yourself in a situation detected as critical by Active Brake Assist, or apply the brake during autonomous braking, situation-dependent braking assistance occurs. The brake pressure increases up to maximum full-stop braking if necessary.

If the autonomous braking function or the situation-dependent braking assistance is triggered, additional preventive measures for occupant protection (PRE-SAFE®) may also be initiated, if the vehicle is equipped with these.

⚠ WARNING Risk of an accident caused by limited detection performance of Active Brake Assist

Active Brake Assist cannot always clearly identify objects and complex traffic situations.

In such cases, Active Brake Assist might:

- Give a warning or brake without reason

- Not give a warning or not brake
- ▶ Always pay careful attention to the traffic situation; do not rely on Active Brake Assist alone. Active Brake Assist is only an aid. The driver is responsible for maintaining a suitable distance to the vehicle in front, vehicle speed and for braking in good time.
- ▶ Be prepared to brake or swerve if necessary.

Observe the system limitations of Active Brake Assist.

**The individual subfunctions are available in the following speed ranges:
Distance warning function**

The distance warning function issues a warning at speeds:

- From approximately 4 mph (7 km/h), if your vehicle is critically close to a vehicle or pedestrian. An intermittent warning tone sounds and the  distance warning lamp lights up in the instrument cluster.

Brake immediately or take evasive action, provided it is safe to do so and the traffic situation allows this.

The distance warning function can aid you in the following situations with an intermittent warning tone and a warning lamp:

Vehicles traveling in front	Up to approx. 155 mph (250 km/h)
Stationary vehicles	Up to approx. 50 mph (80 km/h)
Crossing vehicles	No reaction
Moving pedestrians	Up to approx. 50 mph (80 km/h)
Stationary pedestrians	No reaction

Autonomous braking function

If the vehicle is traveling at speeds above approximately 4 mph (7 km/h), the autonomous braking function may intervene in the following situations:

Vehicles traveling in front	Up to approx. 124 mph (200 km/h)
Stationary vehicles	Up to approx. 31 mph (50 km/h)
Crossing vehicles	No reaction
Moving pedestrians	Up to approx. 37 mph (60 km/h)
Stationary pedestrians	No reaction

Situation-dependent braking assistance

Situation-dependent braking assistance may intervene at speeds above approximately 4 mph (7 km/h) in the following situations:

Vehicles traveling in front	Up to approx. 155 mph (250 km/h)
Stationary vehicles	Up to approx. 50 mph (80 km/h)
Crossing vehicles	No reaction
Moving pedestrians	Up to approx. 37 mph (60 km/h)
Stationary pedestrians	No reaction

Canceling a brake application of Active Brake Assist

You can cancel a brake application by Active Brake Assist at any time by:

- Fully depressing the accelerator pedal or with kickdown.
- Releasing the brake pedal.

Active Brake Assist may cancel the brake application when one of the following conditions is fulfilled:

- You maneuver to avoid the obstacle.
- There is no longer a risk of collision.
- An obstacle is no longer detected in front of your vehicle.

System limitations

The system may be impaired or may not function in the following situations:

- In snow, rain, fog, heavy spray, if there is glare, in direct sunlight or in greatly varying ambient light.
- If the sensors are dirty, fogged up, damaged or covered.
- If the sensors are impaired due to interference from other radar sources, e.g. strong radar reflections in parking garages.
- If a loss of tire pressure or a faulty tire has been detected and displayed.

- Full system performance is not available for a few seconds after switching on the ignition or after driving off.
- In complex traffic situations where objects cannot always be clearly identified.
- For pedestrians or vehicles if they move quickly into the sensor detection range.
- For pedestrians who are hidden by other objects.
- If the typical outline of a pedestrian cannot be distinguished from the background.
- If a pedestrian is not detected as such, e.g. due to special clothing or other objects.
- On bends with a tight radius.

Setting Active Brake Assist

Multimedia system:

↳ Vehicle ▶  Assistance
▶ Active Brake Assist

The following settings are available:

- Early
- Medium

- Late

▶ Select a setting.

 Your selection is retained when the vehicle is next started.



Deactivating Active Brake Assist

 It is recommended that you always leave Active Brake Assist activated.

▶ Select **Off**.

The distance warning function and the autonomous braking function are deactivated.

When the vehicle is next started, the **Medium** setting is automatically selected.

 If Active Brake Assist is deactivated, the  symbol appears in the status bar of the multifunction display.

Speed control cruise control

Function of cruise control

Cruise control regulates the speed to the value selected by the driver.

If you accelerate to overtake, for example, the stored speed is not deleted. If you remove your

foot from the accelerator pedal after overtaking, cruise control will resume speed regulation back to the stored speed.

Cruise control is operated using the corresponding steering wheel buttons. You can store any speed above 15 mph (20 km/h) up to the maximum speed.

If you fail to adapt your driving style, cruise control can neither reduce the risk of an accident nor override the laws of physics. It cannot take into account road, weather or traffic conditions. Cruise control is only an aid. You are responsible for the distance to the vehicle in front, for vehicle speed, for braking in good time and for staying in your lane.

Displays on the multifunction display

The status of cruise control and the stored speed are shown in the multifunction display.

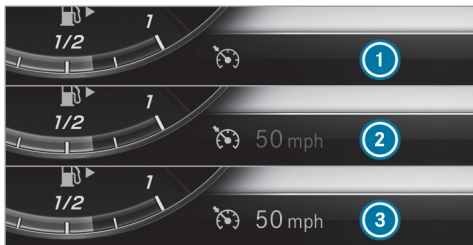

- ① Cruise control is selected
 - ② Speed is saved, cruise control is deactivated
 - ③ Speed is saved, cruise control is activated
- i** The segments between the stored speed and the end of the segment display light up in the speedometer.

System limitations

Cruise control may be unable to maintain the stored speed on uphill gradients. The stored speed is resumed when the gradient evens out.

Change into a lower gear in good time on long and steep downhill gradients. Take particular note of this when driving a laden vehicle. By

doing so, you will make use of the engine's braking effect. This relieves the load on the brake system and prevents the brakes from overheating and wearing too quickly.

Do not use cruise control in the following situations:

- In traffic situations which require frequent changes of speed, e.g. in heavy traffic, on winding roads.
- On slippery roads. Accelerating can cause the drive wheels to lose traction and the vehicle could then skid.
- If you are driving when visibility is poor.

Operating cruise control

⚠ WARNING Risk of accident due to stored speed

If you call up the stored speed and this is lower than your current speed, the vehicle decelerates.

- ▶ Take into account the traffic situation before calling up the stored speed.

Requirements:

- ESP[®] must be activated, but not intervening.
- The driven speed is at least 15 mph (20 km/h).
- The transmission is in position **D**.

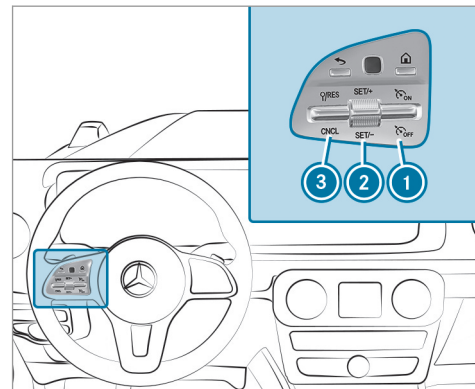

- ▶ **To activate cruise control:** press rocker switch ① up.

or

▶ Press rocker switch ③ up (RES).
The last stored speed is called up and maintained by the vehicle.

If the last stored speed has previously been deleted, the currently driven speed is stored.

ⓘ When you switch off the vehicle, the last speed stored is cleared.

▶ **To increase/reduce speed:** press rocker switch ② up/down to the pressure point. The stored speed is increased or reduced by 1 mph (1 km/h).

or

▶ Press rocker switch ② beyond the pressure point. The stored speed is increased or reduced by 5 mph (10 km/h).

or

▶ Accelerate the vehicle to the desired speed.

▶ Press rocker switch ② up.

If cruise control is activated and Traffic Sign Assist has detected a speed restriction sign with a maximum permissible speed and this is displayed in the instrument cluster:

▶ **To adopt the detected speed:** press rocker switch ③ up.

The maximum permissible speed shown by the traffic sign is stored and the vehicle maintains this speed.

▶ **To deactivate cruise control:** press rocker switch ③ down (CNCL).

▶ **To deactivate cruise control:** press rocker switch ① down.

ⓘ If you brake, deactivate ESP® or if ESP® intervenes, cruise control is deactivated. When you switch off the vehicle, the last speed stored is cleared.

Active Distance Assist DISTRONIC

Function of Active Distance Assist DISTRONIC

Active Distance Assist DISTRONIC maintains the set speed on free-flowing roads. If vehicles in front are detected, the set distance is maintained, if necessary, until the vehicle comes to a halt. The vehicle accelerates or brakes depending on the distance to the vehicle in front and the set speed. The speed (in the range between

15 mph (20 km/h) and 120 mph (200 km/h)) and the distance to the vehicle in front are set and saved on the steering wheel.

Other features of Active Distance Assist DISTRONIC:

- Adjusts the driving style depending on the selected drive program (fuel-saving, comfortable or dynamic) (→ page 135)
- Initiates acceleration to the stored speed if the turn signal indicator is switched on to change to the overtaking lane.

Active Distance Assist DISTRONIC is only an aid. The driver is responsible for keeping a safe distance to the vehicle in front, for vehicle speed and for braking in good time.

System limitations

The system may be impaired or may not function in the following instances:

- In snow, rain, fog, heavy spray, if there is glare, in direct sunlight or in greatly varying ambient light.
- If there is swirling dust, e.g. when driving off-road or on sandy surfaces.

- The windshield in the area of the camera is dirty, fogged up, damaged or covered.
- If the radar sensors are dirty or covered.
- In parking garages or on roads with steep uphill or downhill gradients.
- If there are narrow vehicles in front, such as bicycles or motorcycles.

In addition, on slippery roads, braking or accelerating can cause one or several wheels to lose traction and the vehicle could then skid.

Do not use Active Distance Assist DISTRONIC in these situations.

⚠ WARNING Risk of accident from acceleration or braking by Active Distance Assist DISTRONIC

Active Distance Assist DISTRONIC may accelerate or brake in the following cases, for example:

- If the vehicle pulls away using Active Distance Assist DISTRONIC.

- If the stored speed is called up and is considerably faster or slower than the currently driven speed.
- If Active Distance Assist DISTRONIC no longer detects a vehicle in front or does not react to relevant objects.

- ▶ Always carefully observe the traffic conditions and be ready to brake at all times.
- ▶ Take into account the traffic situation before calling up the stored speed.

⚠ WARNING Risk of accident due to insufficient deceleration by Active Distance Assist DISTRONIC

Active Distance Assist DISTRONIC brakes your vehicle with up to 50% of the maximum possible deceleration. If this deceleration is not sufficient, Active Distance Assist DISTRONIC alerts you with a visual and acoustic warning.

- ▶ In these cases, adjust your speed and keep a sufficient distance.
- ▶ Brake the vehicle yourself and/or take evasive action.

⚠ WARNING Risk of accident if detection function of Active Distance Assist DISTRONIC is impaired

Active Distance Assist DISTRONIC does not react or has a limited reaction:

- when driving on a different lane or when changing lanes
- to pedestrians, animals, bicycles or stationary vehicles, or unexpected obstacles
- to complex traffic conditions
- to oncoming vehicles and crossing traffic

As a result, Active Distance Assist DISTRONIC may neither give warnings nor intervene in such situations.

- ▶ Always observe the traffic conditions carefully and react accordingly.

Operating Active Distance Assist DISTRONIC

Requirements:

- The vehicle has been started.
- The electric parking brake is released.
- ESP® is activated and is not intervening.
- The transmission is in position **D**.
- All the doors are closed.
- Check of the radar sensor system has been successfully completed (vehicle traveling faster than 12 mph (20 km/h)).
- Parking Assist PARKTRONIC is not being used to park the vehicle or to exit from a parking space.
- The vehicle does not skid.

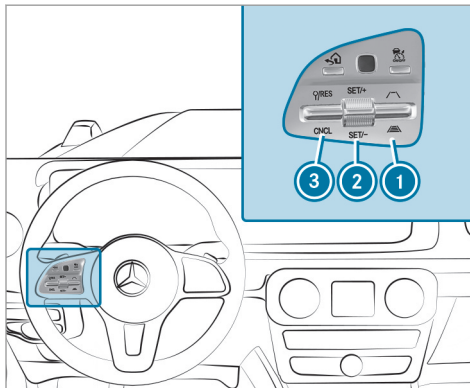

▶ **To activate/deactivate Active Distance Assist DISTRONIC:** press button **1**.

▶ **To activate Active Distance Assist DISTRONIC:** press rocker switch **3** up (SET+) or down (SET-), or press rocker switch **4** up. Remove your foot from the accelerator pedal.
The current speed is stored and maintained by the vehicle.

or

▶ **To activate Active Distance Assist DISTRONIC with a stored speed:** press rocker switch **4** up. Remove your foot from the accelerator pedal.

ⓘ If rocker switch **4** is pressed up again after activation with a stored speed, Active Distance Assist DISTRONIC is activated with the speed restriction displayed in the instrument cluster.

▶ **To accept the displayed speed restriction when Active Distance Assist DISTRONIC is active:** press rocker switch **4** up (RES). The speed limit displayed in the instrument cluster is adopted as the stored speed. The vehicle adapts its speed to that of the vehicle in front, but only up to the stored speed.

▶ **To pull away with Active Distance Assist DISTRONIC:** remove your foot from the brake pedal and activate Active Distance Assist DISTRONIC.

▶ Press rocker switch **4** up (RES).

or

- ▶ Depress the accelerator pedal briefly and firmly.
The functions of Active Distance Assist DISTRONIC continue to be carried out.

⚠ WARNING Risk of accident due to Active Distance Assist DISTRONIC still being activated when you leave the driver's seat

If you leave the driver's seat while the vehicle is being braked by Active Distance Assist DISTRONIC only, the vehicle can roll away.

- ▶ Always deactivate Active Distance Assist DISTRONIC and secure the vehicle to prevent it from rolling away before you leave the driver's seat.

- ▶ **To deactivate Active Distance Assist DISTRONIC:** press rocker switch ④ down (CNCL).
- ▶ **To increase/reduce speed:** press rocker switch ③ up/down to the pressure point. The stored speed is increased or reduced by 1 mph (1 km/h).

or

- ▶ Press and hold rocker switch ③ up/down to the pressure point.
The stored speed is increased or reduced in increments of 1 mph (1 km/h).

or

- ▶ Press rocker switch ③ beyond the pressure point.
The stored speed is increased or reduced by 5 mph (10 km/h).

or

- ▶ Press and hold rocker switch ③ beyond the pressure point.
The stored speed is increased or reduced in increments of 5 mph (10 km/h).
- ▶ **To increase or reduce the specified distance from the vehicle in front:** press rocker switch ② up or down.

Overview of Active Distance Assist DISTRONIC displays in the instrument cluster

Assistant display

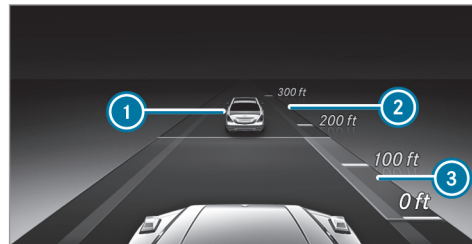

- ① Vehicle in front
- ② Distance indicator
- ③ Set specified distance

Active Distance Assist DISTRONIC status display

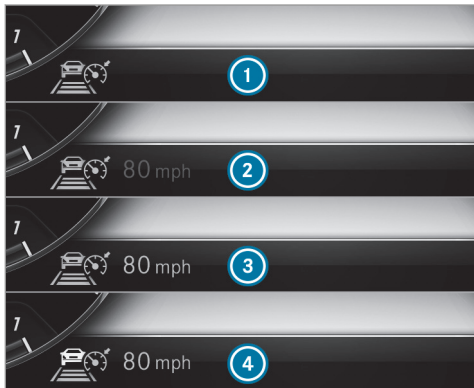

- ① Active Distance Assist DISTRONIC selected, set specified distance (number of segments below the vehicle)
- ② Active Distance Assist DISTRONIC deactivated, speed stored

- ③ Active Distance Assist DISTRONIC active, speed stored, no vehicle detected (gray vehicle symbol)
- ④ Active Distance Assist DISTRONIC active, speed stored, vehicle detected (green vehicle symbol)

Speedometer

The stored speed is highlighted on the speedometer. If the speed of the vehicle in front is less than the stored speed, the segments in the speedometer light up. Activation or deactivation of Active Distance Assist DISTRONIC, as well as alterations to the stored speed and the distance to be maintained, are displayed in the control feedback of the multifunction display on a single line.

Function of Hill Start Assist

Hill Start Assist holds the vehicle for a short time when pulling away on a hill under the following conditions:

- The electric parking brake is released.

This gives you enough time to move your foot from the brake pedal to the accelerator pedal and depress it before the vehicle begins to roll away.

⚠ WARNING Risk of accident and injury due to the vehicle rolling away

After a short time, Hill Start Assist no longer holds the vehicle and it can roll away.

▶ Therefore, swiftly move your foot from the brake pedal to the accelerator pedal. Never attempt to leave the vehicle if it is being held by Hill Start Assist.

HOLD function

HOLD function

The HOLD function holds the vehicle at a standstill without requiring you to depress the brake pedal, e.g. while waiting in traffic.

The HOLD function is only an aid. The responsibility for the vehicle safely standing still remains with the driver.

System limitations

The HOLD function is only intended to provide assistance when driving and is not a sufficient means of safeguarding the vehicle against rolling away when stationary.

- The incline must not be greater than 30%.

Activating/deactivating the HOLD function

⚠ WARNING Risk of an accident due to the HOLD function being activated when you leave the vehicle

If you leave the vehicle while only the HOLD function is braking the vehicle, the vehicle can roll away in the following situations:

- If there is a malfunction in the system or in the power supply.
 - If the HOLD function is deactivated by depressing the accelerator pedal or brake pedal, e.g. by a vehicle occupant.
- ▶ Always deactivate the HOLD function and secure the vehicle against rolling away before leaving the vehicle.

Requirements:

- The vehicle is stationary.
- The driver's door is closed or the seat belt on the driver's side is fastened.
- The engine is running or has been automatically switched off by the ECO start/stop function.
- The electric parking brake is released.
- Active Distance Assist DISTRONIC is deactivated.
- The transmission is in position **D**, **R** or **N**.

Activating the HOLD function

- ▶ Depress the brake pedal and after a short time quickly depress further until the **HOLD** display appears in the multifunction display.
- ▶ Release the brake pedal.

Deactivating the HOLD function

- ▶ Depress the accelerator pedal to pull away.
- or
- ▶ Depress the brake pedal until the **HOLD** display disappears from the multifunction display.

The HOLD function is deactivated in the following situations:

- Active Distance Assist DISTRONIC is activated.
- The transmission is switched to position **P**.
- The vehicle is secured with the electric parking brake.

In the following situations, the vehicle is held by the transmission position **P** or by the electric parking brake:

- The seat belt is unfastened and the driver's door is opened.
- The drive system is switched off.
- There is a malfunction in the system or the power supply is insufficient.

Function of adjustable damping

The variable adjustable damping improves driving comfort and ensures the best possible suspension, even with a laden vehicle. The damping is adjusted depending on the drive program selected or when using the off-road systems.

The adjustable damping consists of:

- Steel suspension
- Three damper settings: **Comfort**, **Sport** and **Off-road**
- Adaptive Damping System with constant damping force adjustment
- DYNAMIC SELECT switch

Available suspension tuning

Drive program	Characteristics
C (Comfort)	The suspension tuning is comfortable.
E (Economy)	The suspension tuning is comfortable.
S (Sport)	The suspension tuning is sporty.
Desert (the availability of this function is dependent on the country) G-Mode	The suspension tuning shifts to Off-road mode.

Parking Assist PARKTRONIC

Function of Parking Assist PARKTRONIC

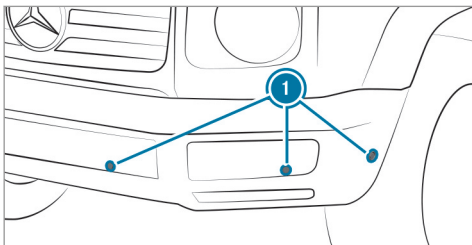

Parking Assist PARKTRONIC is an electronic parking assistance system with ultrasound. It monitors the area around your vehicle using six sensors ① in the front bumper and six sensors in the rear bumper. Parking Assist PARKTRONIC shows you the distance between your vehicle and a detected obstacle visually and audibly.

Parking Assist PARKTRONIC is only an aid. It is not a substitute for your attention to the surroundings. The responsibility for safe maneuvering and parking remains with you. Make sure that there are no persons, animals or objects in

the maneuvering area while maneuvering and parking in/exiting parking spaces.

In the standard setting, an intermittent warning tone sounds from a distance of approximately 1.0 ft (0.3 m) to an obstacle in front and approximately 3.3 ft (1.0 m) to an obstacle behind. A continuous tone sounds from a distance of approximately 0.7 ft (0.2 m). Using the **Warn early** setting in the multimedia system, the warning tones for front and side impact protection can also be set to sound at a greater distance of approximately 3.3 ft (1.0 m) (→ page 177).

① The **Warn early** setting is always active in the rear of the vehicle.

If Parking Assist PARKTRONIC is deactivated, Active Parking Assist is unavailable.

Parking Assist PARKTRONIC display in the multimedia system

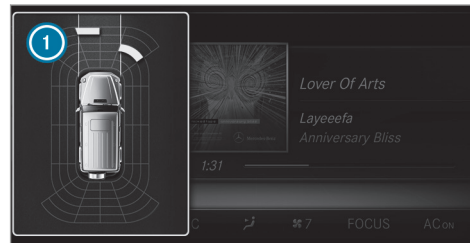

Vehicles with Active Parking Assist without a 360° Camera



Vehicles with Active Parking Assist and a 360° Camera

If Active Parking Assist is deactivated and an obstacle is detected in the path of the vehicle, a pop-up window for Parking Assist PARKTRONIC ① appears in the multimedia system at speeds below 6 mph (10 km/h).

System limitations

Parking Assist PARKTRONIC does not necessarily take into account the following obstacles:

- Obstacles below the detection range, e.g. persons, animals or objects.

- Obstacles above the detection range, e.g. overhanging loads, overhangs or loading ramps of trucks.

The sensors must be free of dirt, ice and slush. Otherwise, they may not function correctly. Clean the sensors regularly, especially after driving off-road, taking care not to scratch or damage them.

Vehicles with trailer hitch: Parking Assist PARKTRONIC is deactivated for the rear zone when you establish an electrical connection between your vehicle and a trailer.

Function of the passive side impact protection

Passive side impact protection is an additional Parking Assist PARKTRONIC function which warns the driver about obstacles at the side of the vehicle. A warning is issued when obstacles are detected between the front and rear detection range. In order for an object to be detected, the sensors in the front and rear bumper must detect the object while you are driving past it.

During the parking procedure or maneuvering, objects are detected as the vehicle drives past.

If you steer in the direction of a detected obstacle and there is a risk of a lateral collision, a warning is issued. The lateral segments light up orange or red, depending on the distance to the obstacle.

Segment color depending on distance

Color	Lateral distance in cm
Red	Approx. < 30
Orange	Approx 30 - 60

In order for lateral front or rear segments to be displayed, the vehicle must first travel a distance of at least half of the vehicle length. Once the vehicle has traveled the length of the vehicle, all of the lateral front and rear segments can be displayed.

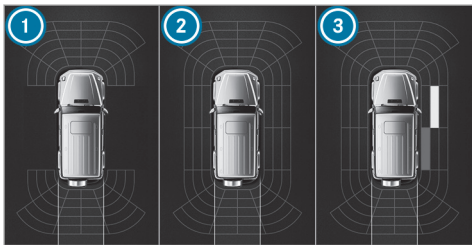

Vehicles without 360° Camera

- ① Parking Assist PARKTRONIC is only operational in the front and rear
- ② Parking Assist PARKTRONIC is operational and can also warn the driver about obstacles at the side of the vehicle
- ③ Obstacle detected at the front right (orange) and rear (red)

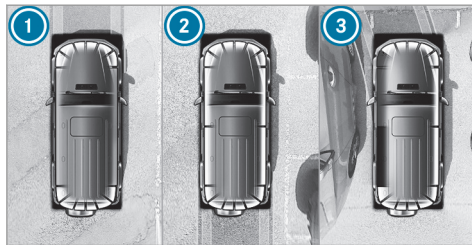

Vehicles with 360° Camera

- ① Parking Assist PARKTRONIC is only operational in the front and rear
- ② Parking Assist PARKTRONIC is operational and can also warn the driver about obstacles at the side of the vehicle
- ③ Obstacle detected at the front right (orange) and rear (red)

Saved obstacles are deleted in the following situations, for example:

- You switch off the vehicle
- You open the doors

After the engine is restarted, obstacles must be detected again before a new warning can be issued.

System limitations

The system limitations for Parking Assist PARKTRONIC apply for passive side impact protection.

The following objects are not detected, for example:

- Pedestrians who approach the vehicle from the side
- Objects placed next to the vehicle

Deactivating/activating Parking Assist PARKTRONIC

! **NOTE** Risk of an accident from objects at close range

Parking Assist PARKTRONIC may not detect certain objects at close range.

- ▶ When parking or maneuvering the vehicle, pay particular attention to any objects which are above or below the sensors, e.g. flower pots or drawbars.

The vehicle or other objects could otherwise be damaged.

If indicator lamp ❶ is not lit, Parking Assist PARKTRONIC is active. If the indicator lamp is lit or the  symbol appears in the multifunction display, Parking Assist PARKTRONIC is not active.

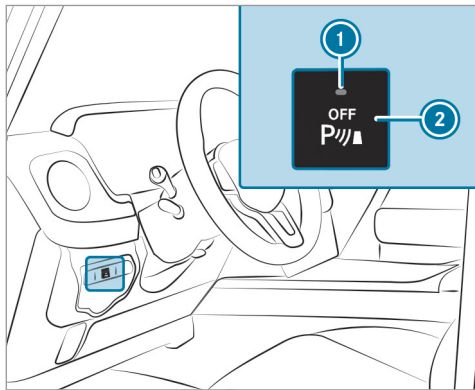

▶ Press button ❷.

- ❶ Depending on the vehicle's equipment, the button may also be located in the center console.
- ❶ Parking Assist PARKTRONIC is automatically activated when the vehicle is started.

Adjusting the warning tones of Parking Assist PARKTRONIC

Multimedia system:

- Vehicle ➤  Assistance
- Camera & Parking ➤ Set Warning Tones

Adjusting the volume of the warning tones

- ▶ Select **Warning Tone Volume**.
- ▶ Set a value.

Adjusting the pitch of the warning tones

- ▶ Select **Warning Tone Pitch**.
- ▶ Set a value.

Specifying the starting point for the warning tones

You can specify whether the Parking Assist PARKTRONIC warning tones should commence when the vehicle is further away from an obstacle.

- ▶ Select **Warn Early**.
- ▶ Activate or deactivate the function.

Activating/deactivating audio fadeout

You can specify whether the volume of a media source in the multimedia system is to be reduced when Parking Assist PARKTRONIC gives an audible warning.

- ▶ Select **Audio Fadeout During Warning Tones**.
- ▶ Activate or deactivate the function.

Reversing camera

Function of the rear view camera

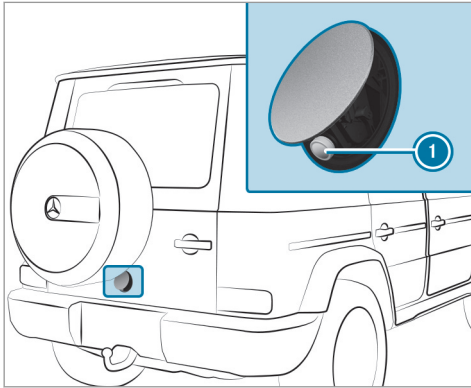

When you engage reverse gear, the image from rear view camera ① is shown in the multimedia system. Dynamic guide lines show the path the vehicle will take with the steering wheel in its current position. This helps you to orient yourself and to avoid obstacles when backing up.

The rear view camera is only an aid. It is not a substitute for your attention to the surroundings. The responsibility for safe maneuvering and parking remains with you. Make sure that there are no persons, animals or objects etc., in the maneuvering area while maneuvering and parking.

Depending on the vehicle equipment, you can select from the following views:

- Normal view
- Wide-angle view

The area behind the vehicle is displayed as a mirror image, as in the inside rearview mirror.

Vehicles with Active Parking Assist

The following camera views are available in the multimedia system:

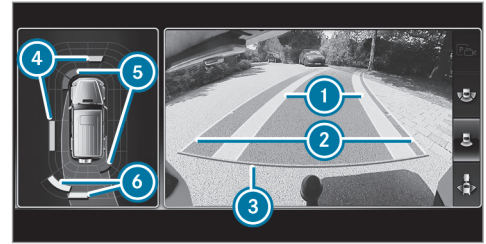

Normal view

- ① Yellow lane marking the course the tires will take at the current steering wheel angle (dynamic)
- ② Yellow guide line, vehicle width (driven surface) depending on the current steering wheel angle (dynamic)
- ③ Red guide line at a distance of approximately 1.0 in (0.3 m) from the rear area
- ④ Yellow warning display of Parking Assist PARKTRONIC: obstacles are at a distance of between approximately 2.0 ft (0.6 m) and 3.3 ft (1.0 m)

- ⑤ Red warning display of Parking Assist PARKTRONIC: obstacles are very close (approximately 1.0 ft (0.3 m) or less)
- ⑥ Orange warning display of Parking Assist PARKTRONIC: obstacles are a medium distance away (between approximately 1.0 ft (0.3 m) and 2.0 ft (0.6 m))
- ① If the entire system fails, the inner segments of the warning display are shown in red. The indicator lamp on the PARKTRONIC button lights up and the  symbol appears in the multifunction display. If the system fails at the rear, the rear segments are shown in red when backing up and the rear segments are hidden when driving forwards . When Active Parking Assist is active, the lanes are displayed in green. If Parking Assist PARKTRONIC is deactivated, the warning display fades out.



Wide-angle view

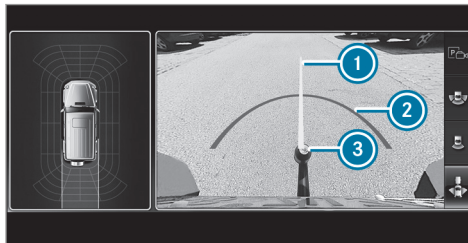

View of trailer (if trailer hitch is installed)

- ① Yellow guide line, locating aid

- ② Red guide line at a distance of approximately 1.0 in (0.3 m) from the ball head of the trailer hitch
- ③ Ball head of the trailer hitch

System limitations

The rear view camera will not function or will only partially function in the following situations:

- The rear-end door is open.
- There is heavy rain, snow or fog.
- The ambient light conditions are poor, e.g. at night.
- The camera lens is obstructed, dirty or fogged up. Observe the notes on cleaning the rear view camera (→ page 348).
- The camera or rear of your vehicle is damaged. In this case, have the camera and its position and setting checked at a qualified specialist workshop.
- ① Do not use the rear view camera in these types of situation. You could otherwise injure others or collide with objects when parking the vehicle.

For technical reasons, inaccuracies in the guide lines and in the display of the generated images may occur in the following situations:

- If the vehicle is carrying a heavy load and leaves the standard height.
- When the differential locks are engaged.

The field of vision and other functions of the rear view camera may be restricted due to additional accessories on the rear of the vehicle (e.g. license plate bracket or bicycle rack).

- ⓘ The contrast of the display may be impaired by direct sunlight or by other light sources, e.g. when driving out of a garage. In this case, pay particular attention.
- ⓘ Have the display repaired or replaced if, for example, pixel errors considerably restrict its use.

360° camera

Function of the 360° Camera

The 360° Camera is a system that consists of four cameras. The cameras cover the immediate vehicle surroundings. The system assists you,

e.g. when parking or at exits with reduced visibility.

- ⓘ You can also use the 360° Camera as an aid when driving off-road.

The 360° Camera is only an aid. It is not a substitute for your attention to the surroundings. The responsibility for safe maneuvering and parking remains with you. Make sure that there are no persons, animals or objects etc., in the maneuvering area while maneuvering and parking.

The system evaluates images from the following cameras:

- Rear view camera
- Front camera
- Two side cameras in the outside mirrors

Views of the 360° Camera

You can select from different views:

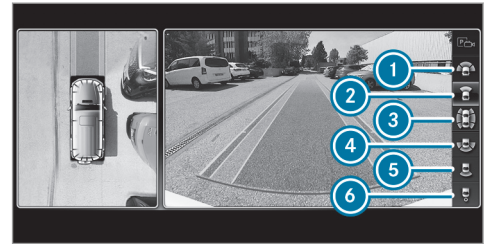

- ① Off-road view
- ② Top view with image from the front camera
- ③ Top view with images from the side cameras in the outside mirrors
- ④ Wide-angle view, rear
- ⑤ Top view with image from the rear view camera
- ⑥ Top view with trailer view (if trailer hitch is installed)

Top view

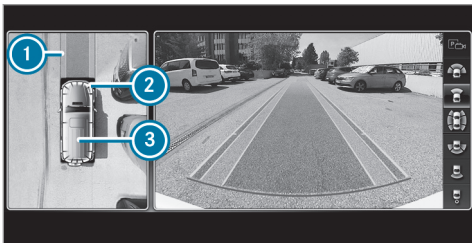

- ① Lane indicating the route the vehicle will take with the steering wheel in its current position
- ② Yellow warning display of Parking Assist PARKTRONIC: obstacles at a distance of approximately 3.3 ft (1.0 m) or less
- ③ Your vehicle from above

If the distance to the object lessens, the color of warning display ② changes. From a distance of approximately 2.0 ft (0.6 m) the warning display is shown in orange. From a distance of approximately 1.0 ft (0.3 m) the warning display is shown in red.

When Parking Assist PARKTRONIC is operational and no object is detected, the segments of the warning display are shown in gray.

- ⓘ If the entire system fails, the segments of the warning display are shown in red. The indicator lamp on the PARKTRONIC button lights up and the  symbol appears in the multifunction display.

If the system fails at the rear, the display of the segments changes as follows:

- The rear segments are shown in red when backing up.
- The rear segments are hidden when driving forwards.

If Parking Assist PARKTRONIC is deactivated, the warning display fades out.

Guide lines

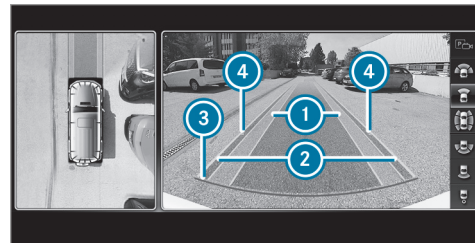

- ① Yellow lane marking the course the tires will take at the current steering wheel angle (dynamic)
 - ② Yellow guide line, vehicle width (driven surface) depending on the current steering wheel angle (dynamic)
 - ③ Red guide line at a distance of approximately 1.0 in (0.3 m) from the rear area
 - ④ Mark at a distance of approx. 3.3 ft (1.0 m)
- ⓘ When Active Parking Assist is active, the lanes are displayed in green.

The guide lines in the multimedia system display show the distances to your vehicle. The distances only apply to road level. In trailer mode, the guide lines are shown at the level of the trailer hitch.

Trailer view (if trailer hitch is installed)

If you select trailer view and no trailer is coupled to the vehicle, the following display appears:

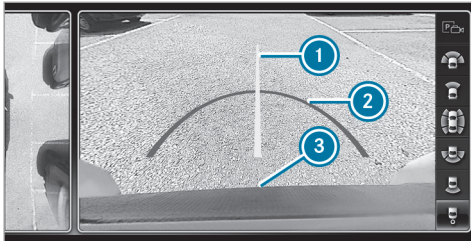

- ① Yellow guide line, locating aid
- ② Red guide line at a distance of approximately 1.0 in (0.3 m) from the ball head of the trailer hitch
- ③ Ball head of the trailer hitch

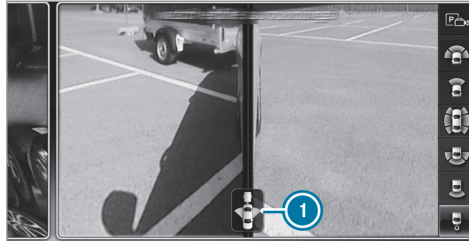

When the electrical connection is established between the vehicle and the trailer, the display changes to side camera view ①.

This view supports maneuvering procedures with a trailer.

Side view of the mirror cameras

The sides of the vehicle can be seen in this view.

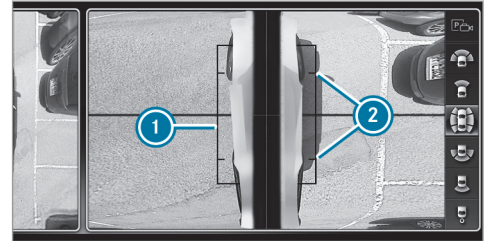

- ① Guide line of external vehicle dimensions with outside mirrors folded out
- ② Marker of the wheel contact points

System failure

If there is no operational readiness, the following message appears in the multimedia system:

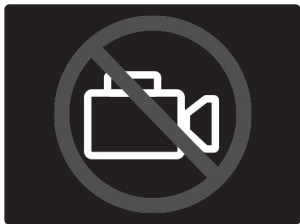

System limitations

The 360° Camera will not function or will only partially function in the following situations:

- The doors are open.
- The side mirrors are folded in.
- The rear-end door is open.
- There is heavy rain, snow or fog.
- The ambient light conditions are poor, e.g. at night.
- The camera lens is obstructed, dirty or fogged up.
- If cameras or vehicle components in which the cameras are installed are damaged. In

this event, have the cameras, their positions and their setting checked at a qualified specialist workshop.

Do not use the 360° Camera under such circumstances. You could otherwise injure others or collide with objects when parking or maneuvering the vehicle.

For technical reasons, inaccuracies in the guide lines and in the display of the generated images may occur in the following situations:

- If the vehicle is carrying a heavy load and leaves the standard height.
- When the differential locks are engaged.

The field of vision and other functions of the camera system may be restricted due to additional attachments on the vehicle (e.g. license plate bracket, bicycle rack).

See the notes on cleaning the 360° Camera (→ page 348).

Selecting a view for the 360° Camera

Requirements:

- The [Auto. Rear View Cam.](#) function is selected in the multimedia system.
- ▶ Engage reverse gear.
 - ▶ In the multimedia system, select the desired view.

Opening the camera cover of the rear view camera

Multimedia system:

▶ [Vehicle](#) ▶ [Assistance](#)
▶ [Camera & Parking](#)

▶ Select [Open Camera Cover](#).

ⓘ The camera cover closes automatically after some time or after an ignition cycle.

Setting the camera as a favorite



You can call up the camera view directly in the multimedia system by setting it as a favorite.

▶ Press the  button on the control element.
The main functions are displayed.

- ▶ Navigate downwards twice. The Favorites menu appears.
- ▶ Select **New Favorite**.
- ▶ Select **Vehicle**.
- ▶ Select **Camera**.

Active Parking Assist

Function of Active Parking Assist

Active Parking Assist is an electronic parking assistance system which uses ultrasound and is automatically activated during forward travel. The system is operational at speeds of up to approximately 22 mph (35 km/h). When all the conditions are fulfilled, the  symbol appears in the multifunction display in the instrument cluster and the system automatically searches for and measures parking spaces on both sides of the vehicle parallel and perpendicular to the direction of travel. If Active Parking Assist is activated, suitable parking spaces are shown in the display of the multimedia system. The  symbol appears in the display of the multimedia system. The arrows show on which side of the roadway free parking spaces are located.

The parking space and, if necessary, the parking direction can be selected as desired. Active Parking Assist calculates a suitable vehicle path and assists you in parking and exiting the parking space.

Active Parking Assist supports by changing gear, accelerating, braking and steering the vehicle.

Active Parking Assist is only an aid. It is not a substitute for your attention to the surroundings. The responsibility for safe maneuvering and parking remains with you. Make sure that no persons, animals or objects etc. are in the maneuvering range.

Active Parking Assist is canceled if, among other things, one of the following actions is carried out:

- You deactivate Parking Assist PARKTRONIC.
- You deactivate Active Parking Assist.
- You begin steering.
- You apply the parking brake.
- You engage transmission position .
- ESP[®] intervenes.

- You open the doors or the trunk lid while driving.
- You open the rear-end door.
- When the differential locks are engaged.

System limitations

Objects located above or below the detection range of Active Parking Assist are not detected when the parking space is being measured. These are also not taken into account when the parking maneuver is calculated, e.g. overhanging loads, overhangs or loading ramps of trucks or the boundaries of parking spaces. In some circumstances, Active Parking Assist may therefore guide you into the parking space prematurely. When the differential locks are engaged, Active Parking Assist does not function.

⚠ WARNING Risk of accident due to objects located above or below the detection range of Active Parking Assist

If there are objects above or below the detection range, the following situations may arise:

- Active Parking Assist may steer too early.
- **Vehicles with automatic transmission:** The vehicle may not stop in front of these objects.

This could cause a collision.

- ▶ In these situations, do not use Active Parking Assist.

Snowfall or heavy rain may lead to a parking space being measured inaccurately. Parking spaces that are partially occupied by trailer drawbars might not be identified as such or be measured incorrectly. Only use Active Parking Assist on level, high-grip ground.

Do not use Active Parking Assist in the following situations:

- In extreme weather conditions such as ice, packed snow or in heavy rain.
- When transporting a load that protrudes beyond the vehicle.
- If the parking space is on a steep downhill or uphill gradient.
- When snow chains are installed.
- When driving off-road.

Active Parking Assist may also display parking spaces that are not suitable for parking, e.g.:

- Parking spaces where parking is prohibited.
- Parking spaces on unsuitable surfaces.

Active Parking Assist will not assist you with parking spaces at right angles to the direction of travel in the following situations:

- If two parking spaces are located immediately next to each other.
- If the parking space is immediately next to a low obstacle such as a curb.

Active Parking Assist will not assist you with parking spaces parallel or at right angles to the direction of travel in the following situations:

- If the parking space is on a curb.
- If the parking space is bordered by an obstacle, e.g. a tree, a post or a trailer.
- Off-road when at a different height.

Parking with Active Parking Assist

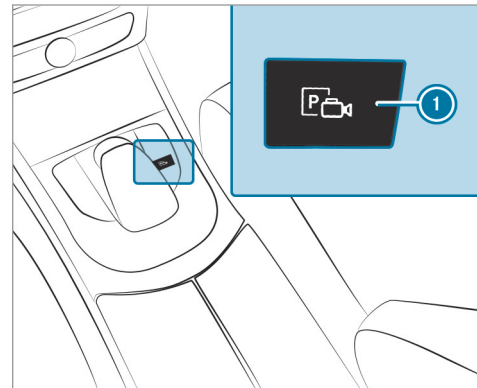

- ▶ Press button ①.

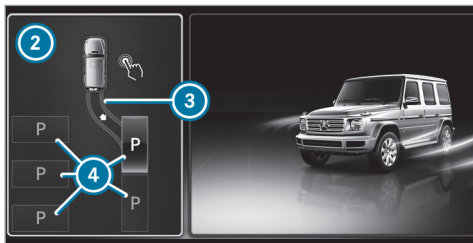

The Active Parking Assist view appears on the multimedia system display. Area ② displays detected parking spaces ④ and vehicle path ③.

- ① Vehicle path ③ shown on the multimedia system display may differ from the actual vehicle path.
- ▶ If you have driven past a parking space: bring the vehicle to a standstill.
- ▶ Select desired parking space ④.

- ▶ Where necessary, select the parking direction: forwards or reverse. Vehicle path ③ is shown, depending on selected parking space ④ and the parking direction.

- ▶ Confirm selected parking space ④.

- ① The turn signal indicator is switched on automatically when the parking procedure begins. The turn signal indicator is switched off automatically when you switch to **D**.

You are responsible for selecting the turn signal in accordance with the traffic conditions. If necessary, select the turn signal accordingly.

⚠ WARNING Risk of accident due to vehicle swinging out while parking or pulling out of a parking space

While parking or exiting a parking space, the vehicle swings out and can drive onto areas of the oncoming lane.

This could cause you to collide with objects or other road users.

- ▶ Pay attention to objects and other road users.
- ▶ Where necessary, stop the vehicle or cancel the parking procedure with Active Parking Assist.

- ▶ If, for example, the **Please Engage Reverse Gear** message appears in the multimedia system display: select the corresponding transmission position. The vehicle drives into the selected parking space.

On completion of the parking procedure, the **Parking Assist Finished, Take Control of Vehicle** display message appears. Further maneuvering may still be necessary.

- ▶ After completion of the parking procedure, safeguard the vehicle against rolling away. When required by legal requirements or local conditions: turn the wheels towards the curb.

- i** You can stop the vehicle and change the transmission position during the parking procedure. The system then calculates a new vehicle path. The parking procedure can then be continued. If no new vehicle path is available, the transmission position will be changed again. If the vehicle has not yet reached the parking space, the parking procedure will be canceled, should a gear be changed.

Exiting a parking space with Active Parking Assist

Requirements:

- The vehicle has been parked with Active Parking Assist.

Please note that you are responsible for the vehicle and surroundings during the entire parking procedure.

- ▶ Start the vehicle.

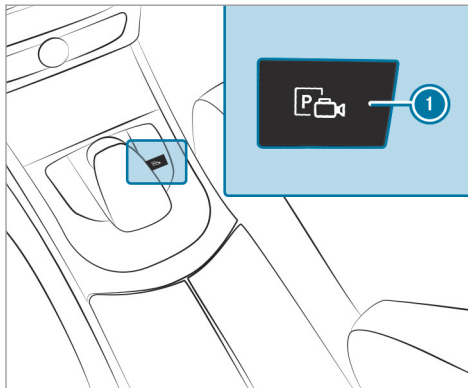

- ▶ Press button **1**. The Active Parking Assist view appears on the multimedia system display.



- ▶ If the vehicle has been parked at right angles to the direction of travel: in area **2**, select direction of travel **3**.
- i** The vehicle path shown on the multimedia system display may differ from the actual vehicle path.
- ▶ Confirm direction of exit **3** to drive out of the parking space.
- i** The turn signal indicator is switched on automatically when the exit the parking space procedure begins.

You are responsible for selecting the turn signal in accordance with the traffic conditions. If necessary, select the turn signal accordingly.

⚠ WARNING Risk of accident due to vehicle swinging out while parking or pulling out of a parking space

While parking or exiting a parking space, the vehicle swings out and can drive onto areas of the oncoming lane.

This could cause you to collide with objects or other road users.

- ▶ Pay attention to objects and other road users.
- ▶ Where necessary, stop the vehicle or cancel the parking procedure with Active Parking Assist.

▶ If, for example, the **Please Engage Forward Gear** message appears in the multimedia sys-

tem display: select the corresponding transmission position. The vehicle moves out of the parking space. The turn signal indicator is switched off automatically.

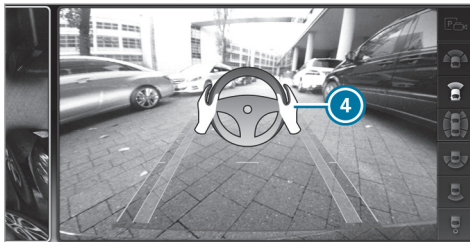

Example: vehicles with 360° Camera

After the exiting procedure has been completed, the **Parking Assist Finished, Take Control of Vehicle** message appears in the display of the multimedia system. A warning tone and display **4** in the display of the multimedia system prompt you to take over control of the vehicle. You have to accelerate, brake, steer and change gear yourself again.

Function of Drive Away Assist

Drive Away Assist can reduce the severity of an impact when pulling away. If an obstacle is detected in the direction of travel, the vehicle's speed is briefly reduced to approx. 1 mph (2 km/h). If a critical situation is detected, the **LIM** symbol appears on the camera image of the multimedia system.

⚠ WARNING Risk of accident caused by limited detection performance of Drive Away Assist

Drive Away Assist cannot always clearly identify objects and traffic situations.

In such cases, Drive Away Assist might:

- Warn you without reason and limit the vehicle speed.
- Not warn you or not limit the vehicle speed.

▶ Always pay careful attention to the traffic situation; do not rely on Drive Away Assist alone.

- ▶ Be prepared to brake or swerve as necessary, provided the traffic situation permits and that it is safe to take evasive action.

Drive Away Assist is only an aid. It is not a substitute for your attention to the surroundings. The responsibility for safe maneuvering and parking remains with you. Make sure that no persons, animals or objects etc. are in the maneuvering range.

A risk of a collision may arise in the following situations, for example:

- If the driver mixes up the accelerator and brake pedals.
- If the wrong gear is selected.

The Drive Away Assist function is active under the following conditions:

- If Parking Assist PARKTRONIC is activated.
- Every time the gear is changed to **R** or **D** when the vehicle is at a standstill.
- If the detected obstacle is less than approx. 3.3 ft (1.0 m) away.

- If the maneuvering assistance function is activated in the multimedia system.

System limitations

Drive Away Assist is not available on inclines and when driving with a trailer.

Function of Cross Traffic Alert

- ⓘ Also read the instructions on Blind Spot Assist (→ page 193).



Vehicles with Blind Spot Assist: drivers can also be warned of any crossing traffic when backing up out of a parking space. If a critical situation is detected, symbol ⓘ appears in the multimedia system display. If the driver does not

respond to the warning, the vehicle's brakes can be applied automatically. To do this, the function uses the radar sensors in the bumper. The area adjacent to the vehicle is continually monitored.

If the radar sensors are obstructed by vehicles or other objects, detection is not possible.

The Cross Traffic Alert function is active under the following conditions:

- If Blind Spot Assist is activated.
- If the vehicle is backing up at walking pace.
- If the maneuvering assistance function is activated in the multimedia system.

System limitations

The Cross Traffic Alert function is not available on inclines and when driving with a trailer.

Deactivating/activating maneuvering assistance

Multimedia system:

- ▶ Vehicle ▶ ⓘ Assistance
- ▶ Camera & Parking ▶ Maneuvering Assist.
- ▶ Activate or deactivate the function.

- ① Maneuvering assistance must be active for the function of Drive Away Assist (→ page 188) and Cross Traffic Alert (→ page 189).

ATTENTION ASSIST

Function of ATTENTION ASSIST

ATTENTION ASSIST assists you on long, monotonous journeys, e.g. on highways and trunk roads. If ATTENTION ASSIST detects indicators of fatigue or increasing lapses in concentration on the part of the driver, it suggests taking a break.

ATTENTION ASSIST is only an aid. It cannot always detect fatigue or lapses in concentration in time. The system is not a substitute for a well-rested and attentive driver. On long journeys, take regular breaks in good time that allow for adequate recuperation.

You can choose between two settings.

- **Standard:** normal system sensitivity.
- **Sensitive:** higher system sensitivity. The driver is warned earlier and the attention

level detected by ATTENTION ASSIST is adapted accordingly.

If drowsiness or increasing lapses in concentration are detected, the **ATTENTION ASSIST: Take a Break!** warning appears in the instrument display. You can acknowledge the message and take a break where necessary. If you do not take a break and ATTENTION ASSIST continues to detect increasing lapses in concentration, you will be warned again after a minimum of 15 minutes.



You can have the following status information for ATTENTION ASSIST displayed in the assistance menu of the on-board computer:

- The length of the journey since the last break.
- The attention level determined by ATTENTION ASSIST.

If ATTENTION ASSIST is unable to calculate the attention level and cannot issue a warning, the **System Suspended** message appears.

If a warning is given in the instrument display, the multimedia system offers to search for a rest area. You can select a rest area and start navigation to this rest area. This function can be activated and deactivated in the multimedia system.

If ATTENTION ASSIST is deactivated, the  symbol appears in the assistance graphic in the instrument display when the engine is running. ATTENTION ASSIST is activated automatically when the engine is re-started. The last selected sensitivity level remains stored.

System limitations

ATTENTION ASSIST is active in the 37 mph (60 km/h) to 124 mph (200 km/h) speed range.

The functionality of ATTENTION ASSIST is restricted, and warnings may be delayed or not occur at all in the following situations:

- If you have been driving for less than approximately 30 minutes.
- If the road condition is poor (uneven road surface or potholes).
- If there is a strong side wind.
- If you adopt a sporty driving style (high cornering speeds or high rates of acceleration).
- If the time has been set incorrectly.
- In active driving situations, if you change lanes and vary your speed frequently.

The ATTENTION ASSIST tiredness or alertness assessment is deleted and restarted when continuing the journey in the following situations:

- If you switch off the engine.

- If you unfasten your seat belt and open the driver's door (e.g. changing drivers or taking a break).

Setting ATTENTION ASSIST

Multimedia system:

- ➔ Vehicle ➔  Assistance
- ➔ ATTENTION ASSIST

Setting options

- ▶ Select **Standard**, **Sensitive** or **Off**.

Suggesting a rest area

- ▶ Select **Suggest Rest Area**.
- ▶ Activate or deactivate the function . If ATTENTION ASSIST detects fatigue or increasing lack of attention, it suggests a rest area in the vicinity.
- ▶ **Select a suggested rest area:** you are guided to the selected rest area.

Traffic Sign Assist

Function of Traffic Sign Assist

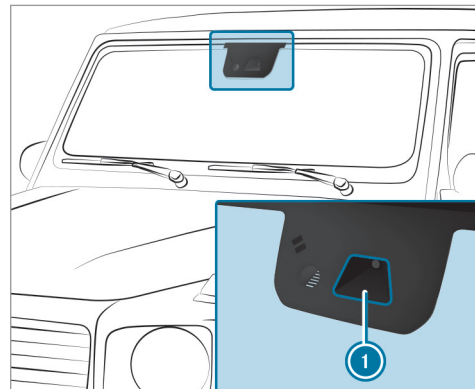

Traffic Sign Assist detects traffic signs with multifunction camera ①. It assists you by displaying detected speed limits and overtaking restrictions in the instrument cluster.

Since Traffic Sign Assist also uses the data stored in the navigation system, it can update the display in the following situations without detecting traffic signs:

- When the vehicle changes roads, e.g. a free-way entry or exit road.
- When a village or city boundary which is stored in the digital map is crossed.

The camera also detects traffic signs with a restriction indicated by an additional sign (e.g. in wet conditions).

Traffic Sign Assist is only an aid. The driver is responsible for keeping a safe distance to the vehicle in front, for vehicle speed and for braking in good time.

Warning when the maximum permissible speed is exceeded

The system can warn you if you unintentionally exceed the maximum permissible speed. To do this, you can specify in the multimedia system by how much the maximum permissible speed can be exceeded before a warning is issued. You can specify whether the warning is to be just a visual warning or an acoustic one as well.

Display in the Instrument Display

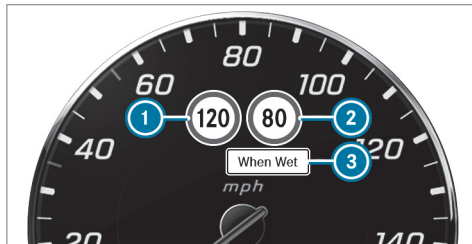

Instrument Display in the Widescreen Cockpit

- ① Permissible speed
- ② Permissible speed when there is a restriction
- ③ Additional sign with restriction



Traffic Sign Assist is not available in all countries. If it is unavailable, display ① is shown in the speedometer.

System limitations

The system may be impaired or may not function in the following situations:

- If there is poor visibility, e.g. due to insufficient illumination of the road, if there are highly variable shade conditions or in rain, snow, fog or heavy spray.
- If there is glare, e.g. from oncoming traffic, direct sunlight or reflections.

- If the windshield in the area of the multifunction camera is dirty, or if the camera is fogged up, damaged or covered.
- If the traffic signs are hard to detect, e.g. due to dirt or snow, or because they are covered or due to insufficient lighting.
- If the information in the navigation system's digital map is incorrect or out-of-date.
- If the signs are ambiguous, e.g. traffic signs on construction sites or in adjacent lanes.
- If you turn sharply when traffic signs are outside the camera's field of vision.

Setting Traffic Sign Assist

Multimedia system:

- Vehicle ➤  Assistance
- Speed Limit Warning

Displaying detected traffic signs in the media display

- Select **Display in COMAND**.
- Activate or deactivate the function.

Adjusting the type of warning

- Select **Visual & Audible**, **Visual** or **None**.

Adjusting the warning threshold

This value determines the speed at which a warning is issued when exceeded.

- Select **Warning Threshold**.
- Set the desired speed.

Blind Spot Assist with exit warning

Function of Blind Spot Assist with exit warning



Blind Spot Assist uses two lateral, rear-facing radar sensors to monitor the area up to 130 ft (40 m) behind your vehicle and 10 ft (3 m) directly next to your vehicle.

If a vehicle is detected at speeds above approximately 8 mph (12 km/h) and this vehicle subsequently enters the monitoring range directly next to your vehicle, the warning lamp in the outside mirror lights up red.

If a vehicle is detected close to the side of your vehicle, the red warning lamp in the outside mirror flashes. If you switch on the turn signal indicator in the corresponding direction, a warning tone sounds once. If the turn signal indicator remains switched on, all other detected vehicles are indicated only by the flashing of the red warning lamp.

If you overtake a vehicle quickly, no warning is given.

⚠ WARNING Risk of accident despite Blind Spot Assist

Blind Spot Assist does not react to vehicles approaching and overtaking you at a greatly different speed.

As a result, Blind Spot Assist cannot warn drivers in this situation.

- ▶ Always pay careful attention to the traffic situation and maintain a safe distance at the side of the vehicle.

Blind Spot Assist is only an aid. It may fail to detect some vehicles and is not a substitute for attentive driving. Always ensure that there is sufficient distance to the side for other road users and obstacles.

Exit warning

The exit warning is an additional function of Blind Spot Assist and can warn vehicle occupants about approaching vehicles when leaving the vehicle when stationary.

⚠ WARNING Risk of accident despite exit warning

The exit warning reacts neither to stationary objects nor to vehicles approaching you at a greatly different speed.

As a result, the exit warning cannot warn drivers in these situations.

- ▶ Always pay particular attention to the traffic situation when opening the doors and make sure there is sufficient clearance.

If there is a vehicle in the monitoring range, this is indicated in the outside mirror. If a vehicle occupant opens the door on the side with the warning, a warning tone sounds and the warning lamp in the outside mirror starts to flash.

This additional function is only available when Blind Spot Assist is activated and up to a maximum of three minutes after the ignition has been switched off. The exit warning is no longer available once the warning lamp in the outside mirror flashes three times.

The exit warning is only an aid and not a substitute for the attention of vehicle occupants. The responsibility for opening and closing the doors and for leaving the vehicle remains with the vehicle occupants.

System limitations

The system may be limited in the following situations:

- The sensors are dirty or covered.
- Poor visibility, e.g. due to fog, heavy rain, snow or spray.
- Narrow vehicles, e.g. bicycles, are within the monitoring range.

Warnings may be issued in error when driving close to crash barriers or similar solid lane borders. Warnings may be interrupted when driving alongside long vehicles, for example trucks, for a prolonged time.

Blind Spot Assist is not operational when reverse gear is engaged.

The exit warning may be limited in the following situations:

- When the sensors are covered by adjacent vehicles in narrow parking spaces.
- When people approach the vehicle.
- Stationary or slow-moving objects are not indicated.

Activating/deactivating Blind Spot Assist

Multimedia system:

➤ Vehicle ➤ Assistance

➤ Blind Spot Assist

▶ Activate or deactivate the function.

Active Lane Keeping Assist

Function of Active Lane Keeping Assist

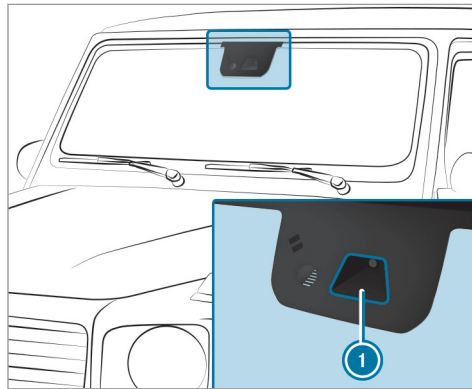

Active Lane Keeping Assist monitors the area in front of your vehicle by means of multifunction camera ①. It serves to protect you against unintentionally leaving your lane. You will be warned by vibration pulses in the steering wheel and gui-

ded by a course-correcting brake application back into your lane.

You are warned by vibration pulses in the steering wheel in the following circumstances:

- Active Lane Keeping Assist detects a lane marking.
- A front wheel drives over this lane marking.

You will also be guided back into your lane by means of a course-correcting brake application if the following conditions are met:

- Active Lane Keeping Assist detects lane markings on both edges of the lane.
- A front wheel drives over a solid lane marking.

You can activate or deactivate the Active Lane Keeping Assist warning.

Whether a warning is issued and when this occurs also depends on the selected sensitivity setting (standard or adaptive).

Active Lane Keeping Assist can neither reduce the risk of an accident if you fail to adapt your driving style nor override the laws of physics. It

cannot take into account road, weather or traffic conditions. Active Lane Keeping Assist is only an aid. You are responsible for the distance to the vehicle in front, for vehicle speed, for braking in good time and for staying in your lane.

Active Lane Keeping Assist can bring the vehicle back into the lane with a lane-correcting brake application. In the case of a broken lane marking being detected, a brake application will only be made if a vehicle has been detected in the adjacent lane. Oncoming traffic can be detected.

Active Lane Keeping Assist is available in the speed range between 37 mph (60 km/h) and 124 mph (200 km/h).



If a lane-correcting brake application occurs, display ① appears in the multifunction display.

System limitations

No lane-correcting brake application occurs in the following situations:

- You clearly and actively steer, brake or accelerate.
- You have switched on the turn signal indicator (situation-dependent).
- A driving safety system intervenes, such as ESP®, Active Brake Assist or Active Blind Spot Assist.
- You have adopted a sporty driving style with high cornering speeds or high rates of acceleration.
- When ESP® is deactivated.
- If a loss of tire pressure or a faulty tire has been detected and displayed.

The system may be impaired or may not function in the following situations:

- If there is poor visibility, e.g. due to insufficient illumination of the road, if there are

highly variable shade conditions or in rain, snow, fog or heavy spray.

- If there is glare, e.g. from oncoming traffic, the sun or reflections.
- If the windshield in the area of the multifunction camera is dirty, or if the camera is fogged up, damaged or covered.
- If there are no lane markings, or several unclear lane markings are present for one lane, e.g. around roadworks.
- If the lane markings are worn, dark or covered.
- If the distance to the vehicle in front is too short and thus the lane markings cannot be detected.
- If the lane markings change quickly, e.g. lanes branch off, cross one another or merge.
- If the roadway is very narrow and winding.

Activating/deactivating Active Lane Keeping Assist (vehicles with Parking Assist PARKTRONIC)

⚠ WARNING Risk of accident despite Active Lane Keeping Assist warning

A lane-correcting brake application cannot always bring the vehicle back into the original lane.

- ▶ Always steer, brake or accelerate yourself, especially if Active Lane Keeping Assist warns you or makes a lane-correcting brake application.

⚠ WARNING Risk of accident despite intervention of Active Lane Keeping Assist

Active Lane Keeping Assist does not detect traffic conditions or road users. In very rare cases, the system may make an inappropriate brake application, e.g. after intentionally driving over a solid lane marking.

The brake application can be interrupted at any time if you steer slightly in the opposite direction.

- ▶ Always make sure that there is sufficient distance to the side for other traffic or obstacles.

⚠ WARNING Risk of accident despite Lane Keeping Assist

Lane Keeping Assist cannot always clearly detect lane markings.

In such cases, Lane Keeping Assist can:

- give an unnecessary warning
 - not give a warning
- ▶ Always pay particular attention to the traffic situation and keep within the lane, especially if Active Lane Keeping Assist alerts you.

Be sure to observe the system limitations of Active Lane Keeping Assist.

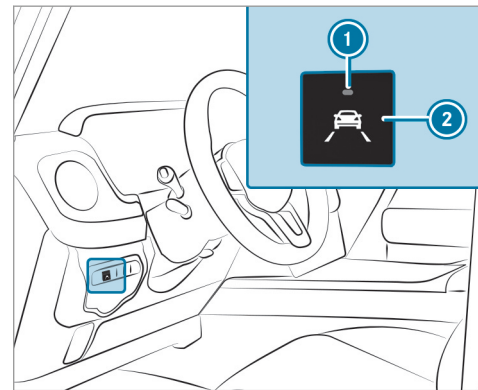

Vehicles with Parking Assist PARKTRONIC:

- ▶ **To activate:** press button ②.
- ▶ **To deactivate:** press and hold button ②. If indicator lamp ① lights up, Active Lane Keeping Assist is activated, the lane markings are shown as light in the assistance graphic. When Active Lane Keeping Assist is active, the lane markings are shown in green in the assistance graphic.

Vehicles without Parking Assist PARKTRONIC:

- ▶ Activate/deactivate Active Lane Keeping Assist via the multimedia system (→ page 198).

Sensitivity of Active Lane Keeping Assist

With the Standard or Adaptive setting, you can influence when the warning vibration of Lane Keeping Assist takes place.

In both the Standard and Adaptive settings, no warning vibration occurs in the following situations:

- You have switched on the turn signal indicator.
- A driving safety system intervenes, such as ABS, BAS or ESP®.

In the Adaptive setting, there will also be no warning vibration in the following situations:

- The vehicle is accelerated or braked considerably.
- You steer actively, e.g. swerve to avoid an obstacle or change lane quickly.

- You cut the corner on a sharp bend.

Setting the sensitivity of Active Lane Keeping Assist

Multimedia system:

↳ Vehicle ▶  Assistance

▶▶ Act. Lane Keep. Assist

- ▶ Select **Adaptive** or **Standard**.
Active Lane Keeping Assist is activated with the selected setting.

or

- ▶ Select **Off**.
Active Lane Keeping Assist is deactivated.

Trailer hitch

Notes on towing a trailer

Mercedes-AMG vehicles: always observe the notes in the Supplement. Otherwise, you may not recognize dangers.

Observe the following notes on the tongue weight:

- Do not use a tongue weight that exceeds or falls below the permissible tongue weight
- Use a tongue weight as close as possible to the maximum tongue weight

Do not exceed the following values:

- Permissible towing capacity
- Permissible rear axle load of the towing vehicle
- Permissible gross mass of the towing vehicle
- Permissible gross mass of the trailer
- Maximum permissible speed of the trailer

Ensure the following before starting a journey:

- The tire pressure on the rear axle of the towing vehicle is set for a maximum load
- The lighting of the connected trailer is operational
- **Vehicles without LED headlamps or MULTIBEAM LED headlamps:** the headlamps have been set correctly

In the event of increased rear axle load, the vehicle/trailer combination may not exceed a maximum speed of 62 mph (100 km/h) for reasons concerning the operating permit. This also applies in countries in which the permissible maximum speed for vehicle/trailer combinations is above 62 mph (100 km/h).

Coupling up/uncoupling a trailer

Requirements:

Trailers with a 7-pin plug can be connected to the vehicle with the following adapters:

- Adapter plug
- Adapter cable

The trailer will be correctly detected by the vehicle only if the following conditions are met:

- The trailer is connected correctly
- The trailer lighting system is in working order

The functions of the following systems are affected by a correctly connected trailer:

- Active Lane Keeping Assist

- ESP® trailer stabilization
- Parking Assist PARKTRONIC
- Active Parking Assist
- Blind Spot Assist

Coupling up a trailer

! **NOTE** Damage to the vehicle battery due to full discharge

Charging the trailer battery using the power supply of the trailer can damage the vehicle battery.

- ▶ Do not use the vehicle's power supply to charge the trailer battery.

Information about a suitable ball head for Mercedes-Benz vehicles can be obtained from a qualified specialist workshop, e.g. an authorized Mercedes-Benz Center.

- ▶ Position the trailer on a level surface behind the vehicle and couple it up to the vehicle.



- ▶ Open the socket cap.
- ▶ Insert the plug with lug ① in groove ③ on the socket.
- ▶ Turn the bayonet coupling ② clockwise as far as it will go.
- ▶ Let the cap engage.
- ▶ Secure the cable to the trailer with cable ties (only if you are using an adapter cable).
- ▶ Make sure that the cable is always slack for ease of movement during cornering.

A display message may appear on the multifunction display even if the trailer has been connected correctly:

- LEDs have been installed in the trailer lighting system
 - The current has fallen below the trailer lighting system's minimum current (50 mA).
- i** Accessories can be connected to the permanent power supply up to 180 W, and to the power supply that is switched on via the ignition lock.

Decoupling a trailer

▲ WARNING Risk of being crushed and becoming trapped when uncoupling a trailer

When uncoupling a trailer with an engaged inertia-activated brake, your hand may become trapped between the vehicle and the trailer drawbar.

- ▶ Do not uncouple trailers with an engaged overrun brake.

- ▶ Secure the trailer against rolling away.
- ▶ Disconnect the electrical connection between the vehicle and the trailer.
- ▶ Uncouple the trailer.
- ▶ Place the cover on the ball head.

Vehicle towing instructions

The vehicle is not suitable for the use of tow bar systems that are used for flat towing or dinghy towing, for example. Attaching and using tow bar systems can lead to damage on the vehicle. When you are towing a vehicle with tow bar systems, safe driving characteristics cannot be guaranteed for the towing vehicle or the towed vehicle. The vehicle-trailer combination may swerve from side to side. Comply with the permitted towing methods (→ page 362) and the instructions for towing with both axles on the ground (→ page 363).

Instrument Display overview

Mercedes-AMG vehicles: be sure to observe the information in the Supplement. Otherwise, you may fail to recognize dangers.

⚠ WARNING Risk of accident due to an instrument display malfunction

If the Instrument Display has failed or malfunctioned, you may not recognize function restrictions applying to safety relevant systems.

The operating safety of your vehicle may be impaired.

- ▶ Drive on carefully.
- ▶ Have the vehicle checked immediately at a qualified specialist workshop.

If the operating safety of your vehicle is impaired, park the vehicle safely as soon as possible. Contact a qualified specialist workshop.

Instrument Display (standard)

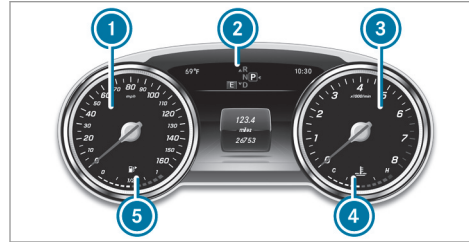

- ① Speedometer
- ② Multifunction display
- ③ Tachometer
- ④ Coolant temperature gauge
- ⑤ Fuel level and fuel filler flap location indicator

Instrument Display in the Widescreen Cockpit

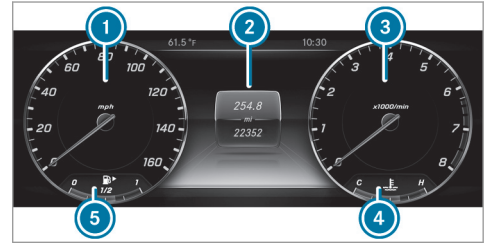

- ① Speedometer
 - ② Multifunction display
 - ③ Example: area for additional values
 - ④ Coolant temperature gauge
 - ⑤ Fuel level and fuel filler flap location indicator
- ⓘ Further display content can be shown on display ③ for additional values (→ page 204).

The segments in speedometer ① indicate the status of the following systems:

- Cruise control (→ page 165)

- Active Distance Assist DISTRONIC
(→ page 167)

! **NOTE** Engine damage due to excessively high engine speeds

The engine will be damaged if you drive with the engine in the overrevving range.

- ▶ Do not drive with the engine in the overrevving range.

The fuel supply is interrupted to protect the engine when the red mark on tachometer ③ (overrevving range) is reached.

During normal operating conditions, coolant temperature display ④ may rise to the red mark.

! **WARNING** Danger of burns when opening the hood

If you open the hood when the engine has overheated or during a fire in the engine compartment, you could come into contact with hot gases or other escaping operating fluids.

- ▶ Before opening the hood, allow the engine to cool down.
- ▶ In the event of a fire in the engine compartment, keep the hood closed and call the fire service.

Overview of the buttons on the steering wheel

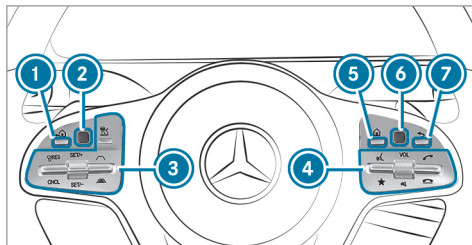

- ① Back/Home button (press and hold), on-board computer
- ② Touch Control, on-board computer

- ③ Control panel for cruise control or Active Distance Assist DISTRONIC
- ④ Control panel for multimedia system:
 - Voice Control System
 - Displays favorites
 - VOL: control knob, adjusts the volume or switches the sound off (press)
 - Makes/accepts a call
 - Rejects/ends a call
- ⑤ Calls up the home screen
- ⑥ Touch Control multimedia system
- ⑦ Back button (press and hold)

Operating the on-board computer

! **WARNING** Risk of distraction from information systems and communications equipment

If you operate information and communication equipment integrated in the vehicle when driving, you will be distracted from the traffic situation. This could also cause you to lose control of the vehicle.

- ▶ Only operate this equipment when the traffic situation permits.
- ▶ If you cannot be sure of this, stop the vehicle whilst paying attention to road and traffic conditions and operate the equipment with the vehicle stationary.

Observe the legal requirements for the country in which you are currently driving when you operate the on-board computer.

- ⓘ The on-board computer displays appear on the multifunction display (→ page 205).

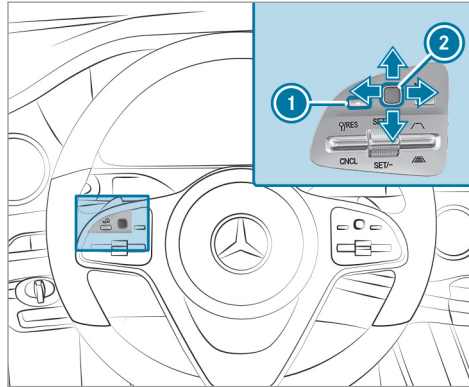

The on-board computer can be operated using left-hand Touch Control ② and left-hand back/home button ①.

When the on-board computer is being operated, different acoustic signals sound as operating feedback, e.g. when the end of a list is reached or when you are scrolling through a list.

The following menus are available:

- [Service](#)

- [Assistance](#)
- [Trip](#)
- [Navigation](#)
- [Radio](#)
- [Media](#)
- [Phone](#)

- **Vehicles with an Instrument Display in the Widescreen Cockpit:** [Designs](#)

The menus can be called up from the menu bar on the multifunction display.

- ▶ **To call up the menu bar:** press the back button on the left ① until the menu bar is displayed.

- ⓘ **Vehicles without Active Distance Assist DISTRONIC:** press the  button to call up the menu bar of the on-board computer.



- ▶ **To scroll in the menu bar:** swipe left or right on left-hand Touch Control ②.
- ▶ **To call up a menu or confirm a selection:** press the left-hand Touch Control ②.
- ▶ **To scroll through displays or lists on the menu:** swipe upwards or downwards on left-hand Touch Control ②.
- ▶ **To call up a submenu or confirm a selection:** press left-hand Touch Control ②.
- ▶ **To exit a submenu:** press back button on the left ①.

Setting the design

On-board computer:

➔ Designs

① This function is only available for vehicles with a Widescreen Cockpit.

The following designs can be selected:

- Classic
- Sport
- Progressive

- ▶ **To select a design:** swipe upwards or downwards on the left-hand Touch Control.
- ▶ Press the left-hand Touch Control. The Instrument Display is shown in the selected design.

Setting the additional value range



Example: G-meter

- ① Additional value range
- ② Index points

- ▶ **To select display content:** swipe to the right on the left-hand Touch Control.
- ▶ Swipe upwards or downwards on the left-hand Touch Control to select display content. When display content is selected, additional value range ① will briefly be highlighted. Index points ② will display the selected list item.

The following display content can be selected in the **Classic** and **Sport** designs:

- Tachometer
- Navigation
- ECO display
- Consumption
- G-Meter

The following content can be selected in the **Progressive** design:

- Date
- Navigation
- ECO display
- Consumption
- G-Meter

Overview of displays on the multifunction display

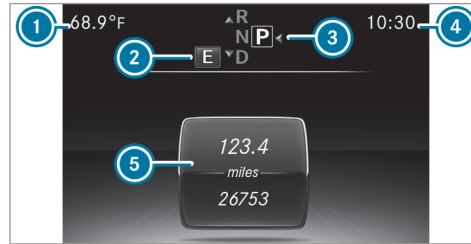

- ① Outside temperature
- ② Drive program
- ③ Transmission position
- ④ Time
- ⑤ Display section

i **Vehicles with an Instrument Display in the Widescreen Cockpit:** the position of the displays will differ from those displayed here.

Further displays on the multifunction display:

- ↑ Gearshift recommendation (→ page 141)
- Active Parking Assist activated (→ page 185)
- Parking Assist PARKTRONIC deactivated (→ page 176)
- Cruise control (→ page 165)
- Active Distance Assist DISTRONIC (→ page 167)
- Active Brake Assist (→ page 165)
- Active Lane Keeping Assist (→ page 195)
- ECO start/stop function (→ page 133)
- Off-road gear (→ page 143)
- On-road position (→ page 143)
- HOLD function (→ page 171)
- Adaptive Highbeam Assist (→ page 111)

Vehicles with Traffic Sign Assist: Detected instructions and traffic signs (→ page 191).

Adjusting the instrument lighting

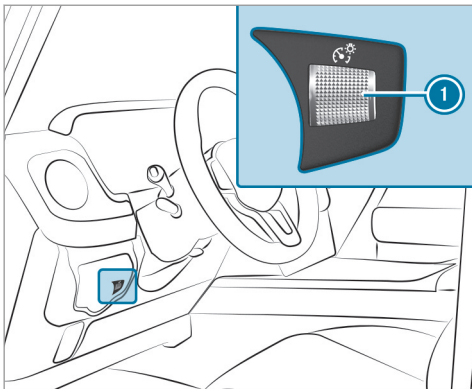

- ▶ Turn brightness control ① up or down. The lighting of the Instrument Display and in the control elements of the vehicle interior is adjusted.

Menus and submenus

Functions on the service menu of the on-board computer

On-board computer:

↳ Service

- ▶ **To select the function:** swipe upwards or downwards on the left-hand Touch Control.
- ▶ Press the left-hand Touch Control.

Functions on the **Service** menu:

- Message memory (→ page 413)
- **Tires:**
 - Check the tire pressure with the tire pressure monitor (→ page 376)
 - Restart the tire pressure monitor (→ page 376)
- **ASSYST PLUS:** calls up the service due date (→ page 336)
- **Vehicles with a Widescreen Cockpit:** **Coolant:** coolant temperature display
- **Engine Oil Level:** engine oil level

Calling up the assistant display

On-board computer:

↳ Assistance

- ① **Vehicles with the Instrument Display in the Widescreen Cockpit:** when you have the design set to **Progressive**, you can view the assistance graphic in the left-hand area of the Instrument Display.

The following displays are available on the assistant display menu:

- Assistant display
- Attention level (→ page 190)
- ▶ **To switch between the displays:** swipe upwards or downwards on the left-hand Touch Control.

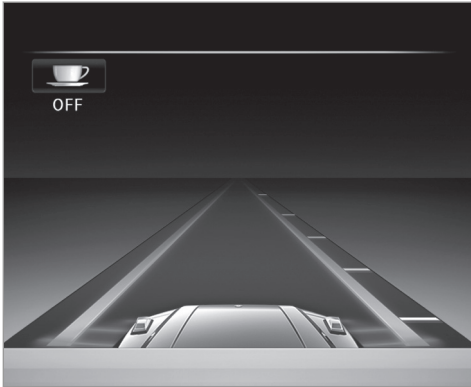

Status displays on the assistant display:

- ☕ OFF: ATTENTION ASSIST deactivated
- Light lane markings: Active Lane Keeping Assist enabled
- Green lane markings: Active Lane Keeping Assist active
- Gray radar waves next to vehicle: Blind Spot Assist activated

- Green radar waves next to vehicle: Blind Spot Assist active
- Active Distance Assist DISTRONIC displays (→ page 167)

Calling up displays on the trip menu

On-board computer:

↪ Trip

i Vehicles with an Instrument Display in the Widescreen Cockpit: When you have the design set to **Progressive**, you can view information about the journey in the left-hand area of the Instrument Display.

▶ To select a display: swipe upwards or downwards on the left-hand Touch Control.

Displays on the **Trip** menu:

- Standard display
- Range and current fuel consumption
If there is only a small amount of fuel left in the fuel tank, the display will show a vehicle being refueled instead of the range.
- ECO display (→ page 134)

- Trip computer **From Start** and **From Reset**
- Digital speedometer

i Vehicles with an Instrument Display in the Widescreen Cockpit: The digital speedometer appears only in the **Classic** and **Sport** designs.

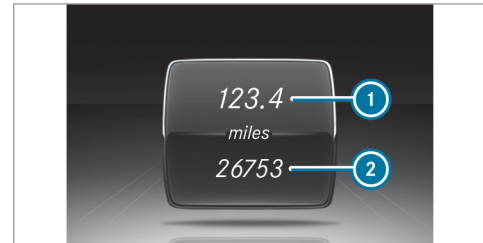

Example: standard display

- 1** Trip distance
- 2** Total distance



Example: trip computer

- ① Total distance
- ② Driving time
- ③ Average speed
- ④ Average fuel consumption

Resetting values on the trip menu of the on-board computer

On-board computer:



Trip

- ① The spelling on the main menu displayed may differ. Therefore, observe the menu

overview for the Instrument Display (→ page 202).

You can reset the values of the following functions:

- Trip distance
- Trip computer [From Start](#) and [From Reset](#)
- ECO display(→ page 134)

▶ **To select the function to be reset:** swipe upwards or downwards on the left-hand Touch Control.

▶ Press the left-hand Touch Control.

▶ Select [Yes](#) .

▶ Press the left-hand Touch Control.

If you press and hold the left-hand Touch Control, the values of the function will be reset immediately.

Calling up navigation instructions on the on-board computer

On-board computer:



Navigation

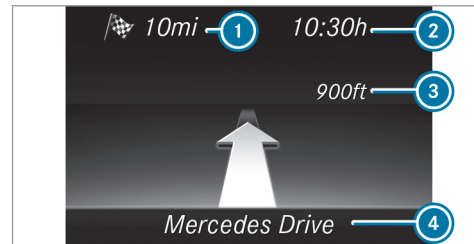

Example: no change of direction announced

- ① Distance to the next destination
- ② Estimated arrival time
- ③ Distance to the next change of direction
- ④ Current road

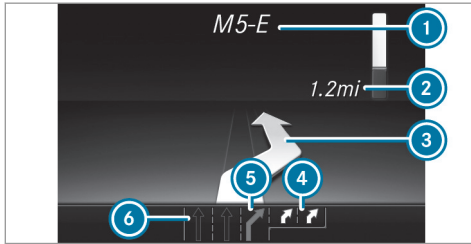

Example: change of direction announced

- ① Road to which the change of direction leads
- ② Distance to the change of direction
- ③ Change-of-direction symbol
- ④ Recommended lane and new lane during a change of direction (white)
- ⑤ Possible lane
- ⑥ Lane not recommended (dark gray)

Further possible displays on the [Navigation](#) menu:

- **Direction of Travel:** display of direction of travel and road currently being traveled on.

- **New Route... or Calculating Route...:** a new route is calculated.
- **Road Not Mapped:** the road is unknown, e.g. for newly built roads.
- **No Route:** no route could be calculated to the selected destination.
- **Off Map:** the map for the current location is not available.
- **Area of Destination Reached:** you have reached the area of destination.
- : you have reached the destination or an intermediate destination.

▶ **To exit the menu:** press the back button on the left.

Vehicles with the COMAND multimedia system: You can also start navigation to one of the recent destinations on the [Navigation](#) menu:

▶ Press the left-hand Touch Control.

▶ **To select a destination:** swipe upwards or downwards on the left-hand Touch Control.

▶ Press the left-hand Touch Control. Route guidance is started.

If route guidance has already been activated, a request will appear asking whether you wish to end the current route guidance.

▶ Select **Yes**.

▶ Press the left-hand Touch Control. Route guidance is started.

Selecting radio stations using the on-board computer

On-board computer:

→ Radio



- ① Frequency range
- ② Station
- ③ Name of track
- ④ Name of artist

When you select a station from the memory presets, the preset will appear next to the station name. When you select a saved station in the frequency range, an asterisk will appear next to the station name.

▶ **To select a radio station:** swipe upwards or downwards on the left-hand Touch Control.

Selecting the frequency range or memory preset

- ▶ Press the left-hand Touch Control.
- ▶ Swipe upwards or downwards on the left-hand Touch Control.
- ▶ Press the left-hand Touch Control.

Media playback using the on-board computer

On-board computer:

→ Media

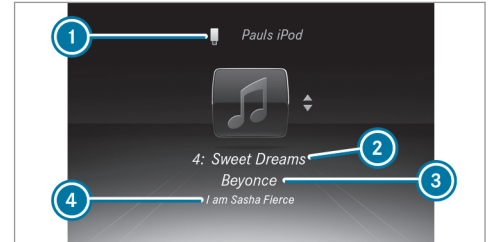

- ① Media source
- ② Track number and current track
- ③ Name of artist (example)
- ④ Name of album

▶ **To change tracks on an active media source:** swipe upwards or downwards on the left-hand Touch Control.

Changing a media source

- ▶ Press the left-hand Touch Control.
- ▶ **To select a media source:** swipe upwards or downwards on the left-hand Touch Control.
- ▶ Press the left-hand Touch Control.

Dialing telephone numbers using the on-board computer

⚠ WARNING Risk of distraction from information systems and communications equipment

If you operate information and communication equipment integrated in the vehicle when driving, you will be distracted from the traffic situation. This could also cause you to lose control of the vehicle.

- ▶ Only operate this equipment when the traffic situation permits.
- ▶ If you cannot be sure of this, stop the vehicle whilst paying attention to road

and traffic conditions and operate the equipment with the vehicle stationary.

When telephoning, you must observe the legal requirements for the country in which you are currently driving.

Requirements:

- The mobile phone is connected to the multimedia system.

On-board computer:

→ Phone

Vehicles with the COMAND multimedia system: The most recent telephone calls (dialed, received and missed calls) are displayed on the **Phone** menu.

- ▶ **To select an entry:** swipe upwards or downwards on the left-hand Touch Control.
- ▶ Press the left-hand Touch Control.
If there is only one telephone number saved to an entry: the telephone number will be selected.
- ▶ **If there are multiple telephone numbers saved to an entry:** swipe upwards or down-

wards on the left-hand touch control to select the desired telephone number.



- ▶ Press the left-hand Touch Control.
The telephone number will be dialed.



The following displays may appear instead of the telephone numbers dialed:

- **Please Wait...:** the application is starting. If a Bluetooth® connection to the mobile phone is not established, the menu for authorizing and connecting a mobile phone will be displayed on the multimedia system (→ page 275).
- **Updating data...:** the call list is being updated.
- **Importing Contacts...:** contacts are being imported from the mobile phone or a storage medium.

Accepting/rejecting a call

Vehicles with Head-up Display: when you receive a call, the **Incoming Call** message will appear on the Head-up Display.

- ▶ Swipe upwards or downwards on the left-hand Touch Control and select  (Accept) or  (Reject).
- ▶ Press the left-hand Touch Control.

You may accept/reject the call using button  or  on the steering wheel.

Notes on operating safety

⚠ WARNING Risk of distraction from information systems and communications equipment

If you operate information and communication equipment integrated in the vehicle when driving, you will be distracted from the traffic situation. This could also cause you to lose control of the vehicle.

- ▶ Only operate this equipment when the traffic situation permits.
- ▶ If you cannot be sure of this, stop the vehicle whilst paying attention to road and traffic conditions and operate the equipment with the vehicle stationary.

⚠ WARNING Risk of distraction from operating mobile communication equipment while the vehicle is in motion

If you operate mobile communication equipment when driving, you will be distracted

from the traffic situation. This could also cause you to lose control of the vehicle.

- ▶ Only operate this equipment when the vehicle is stationary.

For your own safety, always observe the following points when operating mobile communications equipment and especially your voice control system:



- Observe the legal requirements for the country in which you are driving.
- While driving, only operate mobile communications equipment and your voice control system when the traffic conditions permit it. You may otherwise be distracted from the traffic conditions and cause an accident, injuring yourself and others.
- If you use the voice control system in an emergency your voice can change and your telephone call, e.g. an emergency call, can thereby be unnecessarily delayed.
- Familiarize yourself with the voice control system functions before starting the journey.

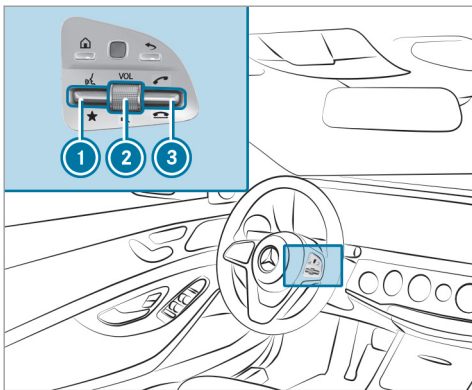

Operation

Overview of operation of the Voice Control System on the multifunction steering wheel

The Voice Control System is operational approximately thirty seconds after the ignition is switched on.



- 1 Press the rocker switch up:  starts the Voice Control System
- 2 Press the control knob:  switches the sound off or on (ends the Voice Control System)
Turn the control knob up/down: increases/decreases the volume

- 3 Press the rocker switch up:  makes/accepts a call
Press the rocker switch down:  rejects/ends a call (ends the Voice Control System)

Conducting a dialog with the Voice Control System

- ▶ **To start or continue a dialog:** on the multi-function steering wheel, press the  rocker switch up.
You can say a voice command after an acoustic signal.
- ▶ **To correct an entry:** say the Correction voice command.
- ▶ **To select an entry from the selection list:** say the line number or the contents.
- ▶ **To browse the selection list:** say the Next or Back voice command.
- ▶ **To interrupt the dialog:** say the Pause voice command.
- ▶ **To cancel the dialog:** say the Cancel voice command.

Operable functions

You can use the Voice Control System to operate the following equipment depending on the features:

- Telephone
- Text messages
- Navigation
- Address book
- Radio
- Audio (memory card, Media Interface, USB and Bluetooth® audio)
- Vehicle

Overview of types of voice command

A distinction is made between the following voice commands:

- **Global voice commands** can be said at any time and regardless of the current application, e.g. the voice commands Navigate to, Call or Text message to.

- **Application-specific voice commands** are only available for the active application.

Once the Voice Control System is started an autocue is shown. Apart from the available voice commands for the application currently active, this also cites example voice commands for other applications which are not active. In this way, you will be familiar more quickly with the available voice commands. The list can be scrolled or it can be operated by speech or the controller/touchpad.

Information on the language setting

You can change the language of the Voice Control System via the system language settings. If the set system language is not supported by the Voice Control System, English will be selected.

The Voice Control System is available in English, French, Portuguese and Spanish.

Using the Voice Control System effectively

Features of audible help functions

You receive information and help for the following topics:

- **Optimum operation:** say the brief instruction voice command.
- **Current application:** on the multifunction steering wheel, press the  rocker switch up and say the Help voice command.
- **Continued dialog:** say the Help voice command during a voice dialog.
- **Specific function:** say voice commands for the desired function, e.g. Help telephone.

Notes on how to improve speech quality

If the Voice Control System does not understand you:

- only operate the Voice Control System from the driver's seat.

- say the voice commands coherently and clearly, but do not exaggerate the words.
- avoid loud noises that cause interference while making a voice command entry, e.g. the blower.

A voice tag in the address book is not recognized:

- only create sensible address book entries in the system/mobile phone, e.g. enter surname and first name in the correct field.
- do not use any abbreviations, unnecessary spaces or special characters.

If a station list entry is not recognized:

- say the Read out station list voice command.

Essential voice commands

Overview of switch voice commands

Switch voice commands can be used to open certain applications. The voice command selection can be used regardless of the application that is currently active.

Switch voice commands

Voice command	Function
Navigation	To switch to navigation mode
Map	To switch to map display
Address book	To switch to address book
Telephone	To switch to telephone mode
Text message	To switch to text messages
Radio	To switch to radio mode
Media	To switch to media mode
USB	To switch to USB
Memory card	To switch to memory card
Internet application <Name>	To start a Mercedes-Benz online application. The application must be called up by touch once prior to use.
Mercedes-Benz Apps	To switch to Mercedes-Benz Apps
Connect	To switch to Internet mode

Voice command	Function
Vehicle menu	To switch to vehicle settings
System settings menu	To switch to system settings

Overview of navigation voice commands

Using navigation voice commands, you can enter POIs or conventional addresses as well as directly change important navigation settings.

Navigation voice commands

Voice command	Function
Navigate to <Address/POI/Contact>	Universal search for all types of destinations. A search is also conducted in the address book contacts, the navigation database and on the Internet (POIs). The order of the details, e.g. city, street or house number, can be changed.
Address in <Country>	Destination entry in a desired country, e.g. address in France
Home	Starts navigation to home address
Work	Starts navigation to your workspace

Voice command	Function
POI <POI>	Destination entry for a POI, e.g. the POI Brandenburg Gate. A search is also performed in the navigation database and on the Internet.
POI online search <POI>	Conducts a POI search on the Internet only
Navigate to contact <Name>	Destination entry to a contact in the address book
Enter country Enter city Enter district Enter street Enter intersection Enter house number Enter ZIP code	Enters a country/city/district/street/intersection/house number/ZIP code
Nearest restaurant Nearest parking lot Nearest rest area with restrooms Nearest gas station	Searches for nearby restaurants, parking spaces, rest areas with restrooms and gas stations

Voice command	Function
Restaurant along the route Parking along the route Rest area with restrooms along the route Gas stations along the route	Searches for restaurants, parking spaces, rest areas with restrooms and gas stations along the route
Restaurant at destination Parking at destination Rest area with restrooms at destination Gas station at destination	Searches for restaurants, parking spaces, rest areas with restrooms and gas stations at the destination
Navigate to <POI category> along the route Navigate to <POI category> at destination Navigate to <POI category> nearby	Navigation to POIs along the route/at the destination/nearby on the basis of the input of specific categories, e.g. gas station, parking lot, cinema
Last destinations	Selects a destination from the list of last entered destinations
Alternative routes	Switches route guidance to another route
Start route guidance	Starts route guidance after entering a valid destination
Cancel route guidance	Cancels route guidance

Voice command	Function
Guidance instructions on Guidance instructions off	Switches the route guidance voice output on/off
Show traffic map Hide traffic map	Switches the traffic map on/off
Switch on POI symbols Switch off POI symbols	Switches the POI symbols display on the map on/off

Overview of telephone voice commands

You can use the telephone voice commands to make phone calls or search through the address book.

Telephone voice commands

Voice command	Function
Call <Name>	Makes a phone call. All address book names are available.
Search for contact <Name>	Searches for and displays a contact. All address book names are available.

Voice command	Function
Outgoing calls	Displays the last call
Redial	Selects the last phone number dialed

Overview of radio voice commands

Radio voice commands can also be used when the radio application is running in the background.

Radio voice commands

Voice command	Function
Station <Name>	To call up receivable or saved stations
<Frequency>	To enter a frequency directly
Next station	To switch to the next available station
Previous station	To switch to the previous station
Save station	To save a station in the station list
Show station list	To display the names of all receivable stations

Voice command	Function
Read out station list	To listen to the names of all receivable stations
Traffic information on Traffic information off	To switch the traffic information service on/off
Radio info on Radio info off	To switch the current station information on/off

Overview of media player voice commands

Media player voice commands can also be used when the media player is running in the background.

Media player voice commands

Voice command	Function
Play <Tracks> Play <Albums> Play <Artists> Play<Composers> Play <Genres> Play <Playlists>	The names of all available tracks, albums, artists, composers, genres or playlists are accepted during the search.
Media search <Track> Media search <Albums> Media search <Artists> Media search <Composers> Media search <Genres> Media search <Playlists>	The names of all available tracks, albums, artists, composers, genres or playlists are accepted during the search.

Voice command	Function
Show all albums Show all artists Show all composers Show all genres Show all tracks Show all playlists	Available albums, artists, composers, genres, tracks or playlists are searched for.
Next track	To select the next track
Previous track	To select the previous track
Random track list on Random track list off	To switch the random track list on/off

Overview of message voice commands

Text messages can be created, edited and listened to using the message voice commands.

Message voice commands

Voice command	Function
Text message to <Name>	To create a message. All address book names are available.
Reply	To reply to a message
Forward text message	To forward a message

Overview of vehicle voice commands

You can use the vehicle voice commands to directly call up the corresponding menus for the vehicle settings.

Vehicle voice commands

Voice command	Function
Ambient light menu	To display ambient light settings
Ambient light "blue"	To switch ambient light to blue
Display and styles menu	To show display settings
Assistance menu	To display assistance settings

Voice command	Function
Energy flow	To display energy flow settings
Ionization menu	To display ionization settings
Climate control menu	To display climate control settings
Automatic climate control driver on	To switch on the automatic climate control settings on the driver's side
Light menu	To display light settings
Massage menu	To display massage settings
Massage driver's seat on	To switch on the massage function for the driver's seat
Massage driver's seat off	To switch off the massage function for the driver's seat
Outside temperature	To display the outside temperature
Engine data	To display engine data
Seats menu	To display seat adjustment settings
Seat heating front passenger level "2"	To set the seat heating for the front passenger seat to level 2
Consumption menu	To display consumption
Vehicle data	To display vehicle data

Overview and operation

Overview of the multimedia system

⚠ WARNING Risk of distraction from information systems and communications equipment

If you operate information and communication equipment integrated in the vehicle when driving, you will be distracted from the traffic situation. This could also cause you to lose control of the vehicle.

- ▶ Only operate this equipment when the traffic situation permits.
- ▶ If you cannot be sure of this, stop the vehicle whilst paying attention to road and traffic conditions and operate the equipment with the vehicle stationary.

You must observe the legal requirements for the country in which you are currently driving when operating the multimedia system.

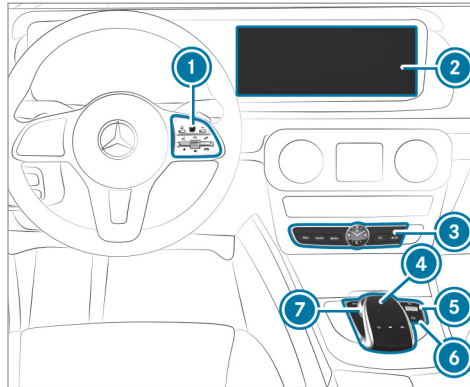

- ① Touch Control
Multimedia system button group on the steering wheel (→ page 202)
- ② Multimedia system display
- ③ Main function button group (→ page 231)
- ④ Touchpad
- ⑤ Control knob
Adjusts the volume(→ page 233)

Switches the mute function on/off (→ page 233)

Mercedes-AMG vehicles: sets the volume (turn) and switches the multimedia system on or off (press)

- ⑥  button

Switches multimedia system on/off

Mercedes-AMG vehicles: sets the volume of the AMG Performance exhaust system (see the separate operating instructions)

- ⑦ Controller

Notes on the media display

! **NOTE** Scratches on the display

The display has a highly sensitive, high-gloss surface. There is a risk of it becoming scratched.

- ▶ Avoid touching the display.
- ▶ Observe the notes on cleaning.

Observe the notes on caring for the interior (→ page 350).

Automatic temperature-controlled switch-off feature: if the temperature is too high, the brightness is initially reduced automatically. The display may then switch off completely for a while.

❗ If you are wearing polarized sunglasses, it may be difficult to read the display.

Central control elements overview

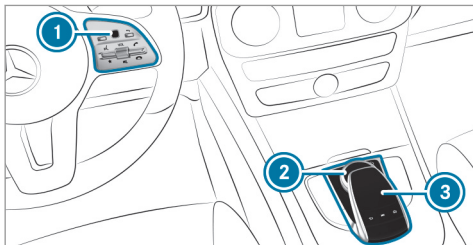

- ❶ Touch Control
- ❷ Controller
- ❸ Touchpad

Touch Control

Operating Touch Control

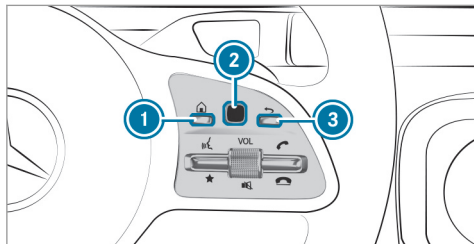

- ▶ **To call up main functions:** press button ❶.
- or
- ▶ Press and hold button ❸.
- ▶ **To call up favorites:** press button ❶.
- ▶ Swipe down on Touch Control ❷.
- ▶ **To open a list:** press Touch Control ❷.
- ▶ **To close a list:** press button ❸.
- or
- ▶ Swipe right on Touch Control ❷.



- ▶ **To select a menu item:** swipe up, down, left or right on Touch Control ❷.
- ▶ Press Touch Control ❷.
- ▶ **To move the digital map:** swipe in any direction.

Setting the sensitivity for the Touch Control Multimedia system:

- ▶ System ▶ Input
- ▶ Touch Control Sensitivity
- ▶ Select **Fast**, **Medium** or **Slow**.

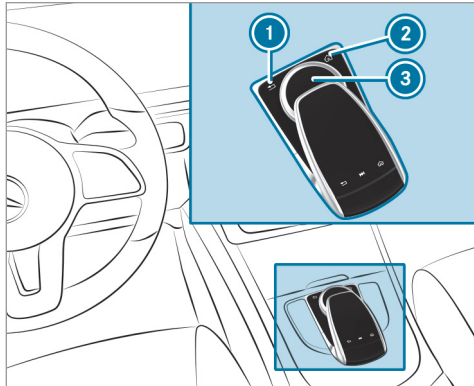
Operating the controller







- ①  button
Press briefly: returns to the previous display
Press and hold: calls up main functions
- ②  button
To call up the main functions

To call up favorites: when the main functions are displayed, slide controller ③ down.

③ Controller

Controller operating options:

- ▶ Turn  counter-clockwise or clockwise.
- ▶ Slide  left or right.
- ▶ Slide  up or down.
- ▶ Slide  diagonally.
- ▶ Press  briefly or press and hold.

Touchpad

Activating/deactivating the touchpad

Multimedia system:

 System  Input



- ▶ Activate or deactivate the Touchpad.

Operating the touchpad

Requirements:

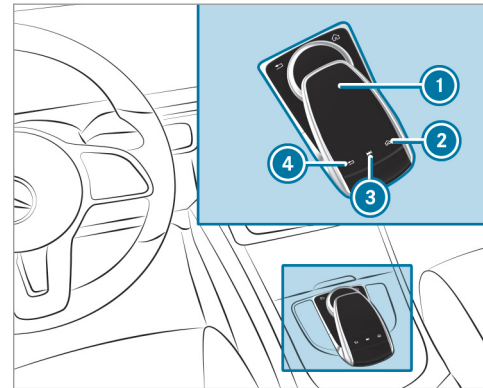
- For vehicles with a controller: the touchpad is switched on (→ page 229).



- ① Touchpad
- ②  button
Calls up main functions and favorites
- ③  button
Calls up the control menu of the last active audio source
- ④  button

Press briefly: returns to the previous display

Press and hold: calls up main functions

You can navigate in menus and lists via touch-sensitive surface ① by using a **single-finger swipe**:

- ▶ **To open or close lists:** swipe left or right.
- ▶ **To select the menu item:** swipe up, down, left or right.
- ▶ Press touchpad ①.
- ▶ **To move the digital map:** swipe in any direction.

Use the following functions with a two-finger swipe:

- ▶ **To call up main functions and favorites:** swipe down with two fingers.
- ▶ **To zoom in and out of the map:** move two fingers apart or together.
- ▶ **To call up the control menu of the last active audio source:** starting in the lower area, swipe up with two fingers.

Setting the sensitivity for the touchpad

Multimedia system:

↳ System ▶  Input

- ▶ Select **Touchpad Sensitivity**.
- ▶ Select **Fast**, **Medium** or **Slow**.
- ▶ **To set the pressure sensitivity:** switch **Touchpad Tap** on or off . If the function is switched on , a tap on the touchpad is enough to select a menu item.

Handwriting recognition: switching the read-aloud function on/off

Multimedia system:

↳ System ▶  Audio

▶▶ System Feedback

- ▶ Switch **Read Out Handwriting Recognition** on or off .

Activating/deactivating haptic operating feedback on the touchpad

Multimedia system:

↳ System ▶  Input

The function supports you when making entries on the touchpad and when selecting menus.

- ▶ Switch **Haptic Operating Feedback** on or off . When the function is activated, a tactile feedback in the form of a vibration is effected when the touchpad is operated.

Selecting a station and track using the touchpad

▶ Press the  button on the touchpad.

or

- ▶ Swipe up with two fingers. The swipe must start in the lower area of the touchpad. The control menu appears for the audio source that was last selected.
- ▶ Use one finger to swipe up or down. Radio: the previous or the next station is set. Media source: the previous or the next music track is selected.

- ▶ **To hide the control menu:** swipe down with two fingers. The swipe must start in the upper area of the touchpad.

Main functions

Calls up the main functions

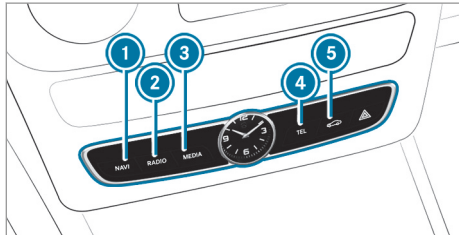

- ① **NAVI** button
Calls up navigation
- ② **RADIO** button
Calls up the radio
- ③ **MEDIA** button
Calls up media
- ④ **TEL** button

- ⑤  button
Sets vehicle functions

- ▶ Alternatively: press the  button on the controller, the touchpad or the Touch Control.
The main functions are displayed.
- ▶ Select the main function.

Favorites

Overview of favorites

Favorites offer you quick access to frequently used applications. It is possible to create 20 favorites in total.

The following functions are available:

- add **pre-defined favorites** from the following categories (→ page 232):
 - Navigation
 - Entertainment
 - Phone
 - Connect

- Vehicle
- System Settings

- add **your own favorites** (→ page 232)
- rename favorites (→ page 232).
- move favorites (→ page 232).
- delete favorites (→ page 232).
- reset all favorites (→ page 232)

Calling up favorites

- ▶ Press the  button.
The main functions are displayed.
- ▶ Navigate downwards once.
Navigating means:
- Swiping on the Touch Control or the touchpad
 - Sliding the controller

Leaving the favorites menu

- ▶ Press the  button.

Adding favorites

Adding predefined favorites



- ▶ Press the  button.
The main functions are displayed.
- ▶ Navigate downwards twice.
The Favorites menu appears.
- ▶ Select **New Favorite**.
The categories are displayed.
- ▶ Select a category.
The favorites are displayed.
- ▶ Select a favorite.
- ▶ Store the favorite at the desired position.
If a favorite has already been added at this position, it will be overwritten.

Example: adding your own favorites

- ▶ Select **Vehicle**.
- ▶ Select **Full Screen: Consumption**.
- ▶ Press and hold the  button until the favorites are displayed.
- ▶ Store the favorite at the desired position.

If **No function available for saving** is shown, the selected function cannot be added.

Renaming favorites

- ▶ Press the  button.
The main functions are displayed.
- ▶ Navigate downwards once.
- ▶ Select a favorite.
- ▶ Navigate downwards once.
The Favorites menu appears.
- ▶ Select **Rename**.
- ▶ Enter the characters.
- ▶ **To confirm the entry:** select .

Moving favorites

- ▶ Press the  button.
The main functions are displayed.
- ▶ Navigate downwards once.
- ▶ Select a favorite.
- ▶ Navigate downwards once.
The Favorites menu appears.
- ▶ Select **Move**.

- ▶ Move the favorite to the desired position.
If a favorite has already been added at this position, it will be overwritten.

Deleting favorites

- ▶ Press the  button.
The main functions are displayed.
- ▶ Navigate downwards once.
- ▶ Select a favorite.
- ▶ Navigate downwards once.
The Favorites menu appears.
- ▶ **To delete:** select **Delete**.
- ▶ Select **Yes**.
- ▶ **To restore all favorites:** select **Reset All**.
A prompt appears.
- ▶ Select **Yes**.
The favorites are reset to the factory settings.

Switching the sound on/off

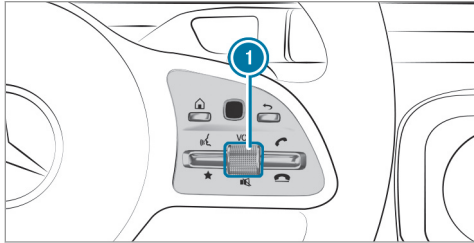

On the multifunction steering wheel

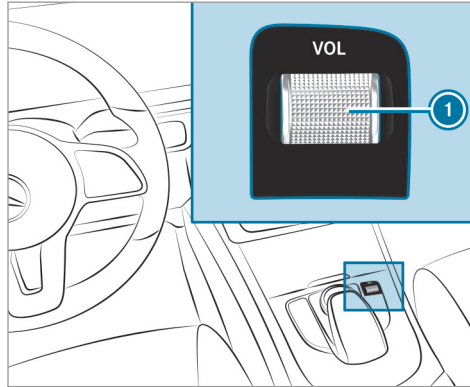

On the multimedia system

▶ **To mute:** press volume control ①.

The  symbol appears in the status line of the media display.

You will also hear traffic announcements and navigation announcements even when the sound is muted.

▶ **To switch on:** change the media source or turn volume control ①.

Adjusting the volume

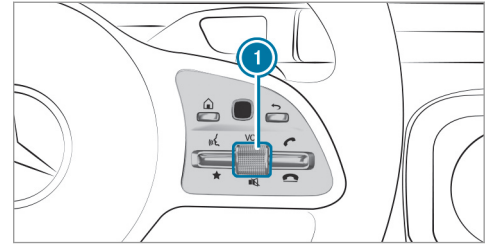

On the multifunction steering wheel

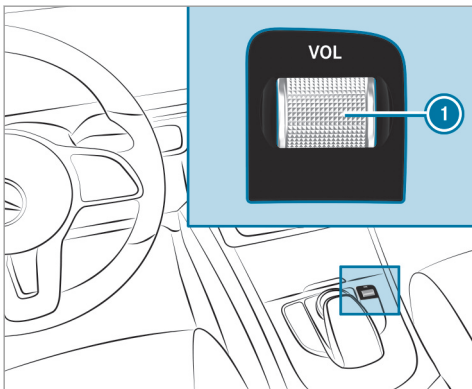

On the multimedia system

- ▶ Turn volume control ①. The volume of the current radio or media source is set. The volume of other audio sources can be adjusted separately. Adjust this in the following situations:
 - during a traffic announcement
 - during a navigation announcement

The volume of the navigation announcement changes in accordance with the volume of the current media source.

- during a telephone call
- when entering or exiting a parking space while using Active Parking Assist

or

- ▶ Select **System** in the multimedia system.
- ▶ Select **Audio**.
- ▶ Select a volume setting.
- ▶ Set the volume.

Entering characters

Using the character input function

⚠ WARNING Risk of distraction from information systems and communications equipment

If you operate information and communication equipment integrated in the vehicle when driving, you will be distracted from the

traffic situation. This could also cause you to lose control of the vehicle.

- ▶ Only operate this equipment when the traffic situation permits.
- ▶ If you cannot be sure of this, stop the vehicle whilst paying attention to road and traffic conditions and operate the equipment with the vehicle stationary.

You must observe the legal requirements for the country in which you are currently driving when operating the multimedia system.

Use the character input function in the following situations, for example:

- Renaming a favorite
- Entering a POI or address
- Making a phone call

The following functions are available:

- Selecting a character in the character bar
- Writing a character on the touchpad

Character input can be started with a control element and resumed with another.

▶ **On the Touch Control and controller:** select the characters in the character bar.

Depending on the target entry, the following characters are available:

- The full set of characters is shown
- Only those characters which are useful for the current input string are shown
Other characters are grayed out.

▶ **On the touchpad:** select the characters in the character bar.

or

▶ Write the characters on the touch-sensitive surface of the touchpad. Handwriting recognition supports you by means of character suggestions and a read-aloud function.

Examples of character entry:

- Renaming a favorite
- Entering a POI or an address using free or step-by-step search
- Entering a web address

Entering characters using the controller

Example: renaming favorites



▶ Call up the "Renaming favorites" function (→ page 232).

▶ **To enter a character:** turn **[⊙]**, slide **↑⊙↓** and press the controller. The character is entered in the input line.

Use the following entry functions:

- [X]** To delete a character: press the controller.
- To delete an entry: press and hold the controller until the entire entry is deleted.

- [⋮]** To switch to special characters and symbols.
- [↑]** To switch to upper-case or lower-case letters.
- [🌐]** To switch the language.
- [👉]** To switch to character entry on the touchpad.

[i] The available editing functions depend on the editing task, the language set and the character level.

▶ **To confirm the entry:** select **[ok]**.

Example: entering a destination (navigation)

▶ Enter the POI or address (→ page 248).

Entering characters on the touchpad

Requirements

- The touchpad is switched on (→ page 229).
- The entered or selected character should be read out: the handwriting recognition read-aloud function is switched on (→ page 230).

Example: renaming a favorite

- ▶ Call up the "Renaming a favorite" function (→ page 232).
- ▶ **To enter a character:** use your finger to write characters on the touchpad. The character is entered in the input line. If different interpretations are possible, character suggestions are displayed.
- ▶ **To select a character suggestion:** turn the controller.
- ▶ Resume character input.
- ▶ **To enter a space:** swipe right when the cursor is located in the input line.

- ▶ **To delete a character:** swipe left when the cursor is located in the input line.
- ▶ **To confirm the entry:** press the touchpad.
- ▶ **To finish character entry:** swipe upwards.

or

- ▶ Press the  button.

Example: entering a destination (navigation)

- ▶ Enter the POI or address (→ page 248).

System settings**Display****Configuring display settings**

Multimedia system:

- ↳ System ▶▶  Display and Designs

Styles

- ▶ Select [Designs](#).
- ▶ Select [Sport](#), [Classic](#) or [Progressive](#).

Adapting the ambient lighting for the style

- ▶ Select [Adjust Amb. Lighting](#).
Activate or deactivate the function.

This function adjusts the ambient lighting for the selected display style.

Setting the display brightness

- ▶ Select [Display Brightness](#).
- ▶ Select a brightness value.

Switching the display off/on

- ▶ **Off:** select [Display Off](#).
- ▶ **On:** press a button, , for example.

Display design

- ▶ Select [Day/Night Design](#).
- ▶ Select [Automatic](#), [Day Design](#) or [Night Design](#).

Additional display area

Depending on the vehicle, various items of additional information can be shown. The additional display area comprises the left-hand or right-hand third of the display.

- ▶ Select [Additional Disp. Area](#).

The following display content can be selected:

- [Dynamic](#)

- Navigation Map
- Consumption
- Time and Date

Time and date

Setting the time and date automatically

Multimedia system:

↳ System ▶  Time and Date

- ▶ Deactivate **Manual Time Adjustment**.
The time and date are set automatically for the selected time zone and summer time option.

- ⓘ The correct time is required for the following functions:
 - Route guidance with time-dependent traffic guidance.
 - Calculation of expected time of arrival.

Setting the time zone

Multimedia system:

↳ System ▶  Time and Date

▶▶ Time Zone:

The list of countries is displayed.

- ▶ Select a country •.
Depending on the country, time zones are displayed.
- ▶ Select a time zone.
The time zone set is displayed after **Time Zone:**.

Setting summer time

The **Automatic Daylight Saving Time** and **Daylight Saving Time** options cannot be selected in all countries.

Multimedia system:

↳ System ▶  Time and Date

Automatically

- ▶ Switch **Automatic Daylight Saving Time** on or off .

Manually

- ▶ Deactivate **Automatic Daylight Saving Time**.
- ▶ Select **Daylight Saving Time**.
- ▶ Select **On** or **Off**.

Setting the time and date format

Multimedia system:

↳ System ▶  Time and Date

▶▶ Set Format

- ▶ Set the date and time format •.

Setting the time manually

Requirements:

- The **Manual Time Adjustment** function is switched on.

Multimedia system:

↳ System ▶  Time and Date

▶▶ Set Time

- ▶ Set the hours.
- ▶ Navigate to the right to set the minutes.
- ▶ Set the minutes.

▶ Confirm changes when exiting the menu.

The date is set automatically via GPS.

Connectivity

Switching transmission of the vehicle position on/off

Multimedia system:

↳ System ▶  Connectivity

- ▶ Select **Transmit Vehicle Pos..**
- ▶ Activate or deactivate the function.

Bluetooth®

Information about Bluetooth®

Bluetooth® technology is a standard for short-range wireless data transfer up to approximately 32.8 ft (10 m).

You can use Bluetooth® to connect your mobile phone to the multimedia system and use the following functions, for example:

- hands-free system with access to the following options:

- contacts (→ page 280)
- call lists (→ page 282)
- text messages
- Internet connection
- listening to music via Bluetooth® audio (→ page 310)
- transferring business cards (vCards) into the vehicle

Bluetooth® is a registered trademark of Bluetooth Special Interest Group (SIG) Inc.

 Internet connection via Bluetooth® is not available in all countries.

Activating/deactivating Bluetooth®

Requirements for switching off Bluetooth®:

- Apple CarPlay™ is not active.

Multimedia system:

↳ System ▶  Connectivity

- ▶ Activate or deactivate Bluetooth®.

If Android Auto is active, a prompt appears asking whether Bluetooth® should be deactivated.

- ▶ Select **Yes**.
Android Auto is closed and Bluetooth® is deactivated.

Wi-Fi

Wi-Fi connection overview

You can use Wi-Fi to establish a connection with a Wi-Fi network and to access the Internet or other network devices.

The following connection options are available:

- Wi-Fi connection
The Wi-Fi connection to a Wi-Fi-capable device, e.g. the customer's mobile phone or a tablet PC is established.
- Multimedia system as a Wi-Fi hotspot
Using this function, a tablet PC or notebook can be connected, for example.

To establish a connection, you can use the following methods:

- WPS PIN

The connection to a secure Wi-Fi network is made via a PIN.

- WPS PBC

The connection to a secure Wi-Fi network is made by pressing a button (push button).

- Security key

The connection to a secure Wi-Fi network is made via a security key.

Setting up Wi-Fi

Requirements:

- The device to be connected supports one of the three means of connection described (→ page 238).

Multimedia system:

↳ System ▶  Connectivity

Activating/deactivating Wi-Fi

- ▶ Switch **Wi-Fi** on or off .
If **Wi-Fi** is deactivated , communication via Wi-Fi to all devices is interrupted. This also means that a connection to the HERMES communication module cannot be estab-

lished. Then functions such as dynamic route guidance with Live Traffic Information are not available.

Connecting the multimedia system with a device via Wi-Fi

This function is available if a HERMES communication module is not installed.

The type of connection established must be selected on the multimedia system and on the device to be connected.

- ⓘ The connection procedure may differ depending on the device. Follow the instructions that are shown in the display. Further information (see the manufacturer's operating instructions).

- ▶ Select **Internet Settings**.
- ▶ Select **Search for Wi-Fi Networks**.

Using a security key

- ▶ Select a Wi-Fi network in the list.
- ▶ Have the security key displayed on the device to be connected (see the manufacturer's operating instructions).

- ▶ Enter this security key on the multimedia system.
- ▶ Confirm the entry with **ok**.
- ⓘ All devices support a security key as a means of connection.

Using a WPS PIN



- ▶ Highlight a Wi-Fi network in the list.
- ▶ Select  **Connect via WPS PIN Input**. The multimedia system generates an eight-digit PIN.
- ▶ Enter this PIN on the device to be connected.
- ▶ Confirm the entry.

Using a button

- ⓘ This function is only available in a Wi-Fi frequency of 2.4 GHz.
- ▶ Highlight a Wi-Fi network in the list.
- ▶ Select  **Connect via WPS PBC**.
- ▶ Select "Connect via WPS PBC" in the options on the device to be connected.
- ▶ Press the WPS button on the device to be connected.

- ▶ Select **Continue** in the multimedia system.

Device has already been connected:

- ▶ **To automatically connect:** highlight a Wi-Fi network in the list.
- ▶ Activate  **Connect Automatically** .
- ▶ **To connect:** highlight a Wi-Fi network in the list.
- ▶ Select  **Connect**.
The connection is established again. These functions are possible when the device has already been connected to the Wi-Fi network.

Setting up a Wi-Fi hotspot

Multimedia system:

 **System** ▶▶  **Connectivity**

Configuring the multimedia system as a Wi-Fi hotspot

The type of connection established depends on the device to be connected. The function must be supported by the multimedia system and by the device to be connected. The type of connection established must be selected on the multi-

media system and on the device to be connected.

- ▶ Select **Set Up Hotspot**.
- ▶ Highlight **Connect Device to Vehicle Hotspot**.

Generating a WPS PIN

- ▶ Select  **Connect via WPS PIN Generation**.
- ▶ Enter the PIN shown in the media display on the device to be connected and confirm.

Connecting using a WPS PIN

- ▶ Select  **Connect via WPS PIN Input**.
- ▶ Select **Enter WPS PIN**.
- ▶ Enter the PIN that is shown on the external device's display on the multimedia system.
- ▶ Select **Continue**.

Connecting using a button

Requirements

- This function is only available in a Wi-Fi frequency of 2.4 GHz.
- ▶ Select  **Connect via WPS PBC**.

- ▶ Press the WPS button on the device to be connected or select **Connect**.
- ▶ Select **Continue** in the multimedia system.

Connecting using a security key

- ▶ Select **Connect Device to Vehicle Hotspot**. A security key is displayed.
- ▶ Select the vehicle from the device to be connected. The vehicle is displayed with the SSID **MB Hotspot XXXXX**.
- ▶ Enter the security key which is shown in the media display on the device to be connected.
- ▶ Confirm the entry.

Connecting using NFC

- ▶ Select **Connection via NFC**.
- ▶ Activate NFC on the mobile device (see the manufacturer's operating instructions).
- ▶ Bring the mobile device into the NFC area of the vehicle (→ page 278).
- ▶ Select **Done**.
The mobile device is now connected to the multimedia system hotspot via NFC.

Generating a new security key:

- ▶ Select [Set Up Hotspot](#).
- ▶ Select [Generate Security Key](#).
A connection will be established with the newly created security key.
- ▶ **To save a security key:** select [Save](#).
When a new security key is saved, all existing Wi-Fi connections are then disconnected. If the Wi-Fi connections are being re-established, the new security key must be entered.

Managing COMAND Touch devices**Requirements:**

- The COMAND Touch app is installed on the external device (e.g. tablet or smartphone).
- Wi-Fi is activated (→ page 239) and the multimedia system is configured as a Wi-Fi hotspot (→ page 240).

Multimedia system:

↳ System ▶▶ COMAND Touch

Connecting and authorizing a new device

- ▶ Select [Authorize a New Device](#).
- ▶ Select [Connect New Device](#).
- ▶ Enter the security key in the external device. The [Please start COMAND Touch on your device and follow the instructions](#). message appears.
- ▶ Select [Continue](#).
- ▶ [Accept](#) the connection request from the new device.
- ▶ Enter the PIN shown on the external device. The device is authorized.

Authorizing a connected device

- ▶ Select [Authorize a New Device](#).
The devices already connected are displayed.
- ▶ Select [Continue Using Connected Devices](#).
The [Please start COMAND Touch on your device and follow the instructions](#). message appears.

- ▶ Select [Continue](#).
- ▶ The connection request from the device [Accept](#).
- ▶ Enter the PIN shown on the external device. The device is authorized.

De-authorizing the device

- ▶ Select an authorized device from the list. A prompt will appear asking whether you would like to de-authorize the selected device.
- ▶ Select [Yes](#).
The device is de-authorized.

Activating/deactivating child safety lock

Multimedia system:

↳ System ▶▶ Parental Control

Locking the Rear Seat Entertainment System

- ▶ Select [Rear Left](#) or [Rear Right](#).
- ▶ Select [Lock](#).
The Rear Seat Entertainment System is locked or unlocked .

Switching off the Rear Seat Entertainment System display

- ▶ Select **Rear Left** or **Rear Right**.
- ▶ Select **Display On**.
- ▶ Switch the display on or off .

Locking an external device

- ▶ Select an external device.
- ▶ Select **Lock**.
The device connected via the COMAND Touch app is locked or unlocked .

System language

Notes on the system language

This function allows you to determine the language for the menu displays and the navigation announcements. The selected language affects the characters available for entry. The navigation announcements are not available in all languages. If a language is not available, the navigation announcements will be in English.

Setting the system language

Multimedia system:

↳ System ▶▶ Language

- ▶ Set the language.
- ⓘ If you are using Arabic map data, the text information can also be shown in Arabic on the navigation map. To do so, select العربية as the language from the language list. Navigation announcements are then also made in Arabic.

Setting the distance unit

Multimedia system:

↳ System ▶▶  Units

- ▶ Select **km** or **mi**.
- ▶ In the multifunction display of the Instrument Display, switch the **Additional Speedometer** display on .

Data import and export

Data import/export function

The following functions are possible:

- Transferring data from one system or vehicle to another system or vehicle.
- Creating a backup copy of your personal data and loading it again.
- Protecting your personal data against unwanted export with PIN protection.
- ⓘ Please note that the NTFS file system is not supported. The FAT32 file system is recommended.

Importing/exporting data

! **NOTE** Loss of data due to premature removal

- ▶ Do not remove the data storage medium when data is being exported.

Mercedes-Benz is not liable for any loss of data.

Requirements:

- The vehicle is stationary.
- The ignition is switched on or the vehicle has been started.
- The SD card is inserted (→ page 301) or the USB device is connected (→ page 304).

Multimedia system:

↗ System ▶ System Backup

▶ Select **Import Data** or **Export Data**.

Importing

▶ Select a data storage medium.
A prompt appears asking whether you really wish to overwrite the current data. If data originates from another vehicle, this is recognized during data reading.

The multimedia system is restarted once the data has been imported.

ⓘ Current vehicle settings can be edited after the import.

Exporting

If PIN protection is activated, your PIN is requested.

- ▶ Enter the four-digit PIN.
- ▶ Select a data storage medium.
The data is exported. The data export may take several minutes.

Activating/deactivating PIN protection

Multimedia system:

↗ System ▶ PIN Protection

Setting the PIN

- ▶ Select **Set PIN**.
- ▶ Enter a four-digit PIN.
- ▶ Enter the four-digit PIN again.
If both PINs match, PIN protection is active.

Changing the PIN

Requirements

- A current PIN must be set.
- ▶ Select **Change Settings**.
- ▶ Enter the current PIN.
- ▶ Select **Change PIN**.
- ▶ Set a new PIN.

Activating PIN protection for data export

- ▶ Select **Change Settings**.
Confirm with the PIN.
- ▶ Select **Protect Data Export**.
Activate or deactivate the function.

Unblocking the PIN

Requirements:

- There is an Internet connection.
- A Mercedes me account exists at <http://www.mercedes.me>.
- The **Personalization** service is active (→ page 244).

If the PIN has been entered incorrectly three times, the PIN will be blocked. You can have a single-use password sent to you via the Mercedes me connect online portal to reset the PIN protection.

- ▶ Select **Unblock PIN**.
- ▶ Enter the single-use password.
PIN protection is reset, and you can set a new PIN.

-  Alternatively, you can have PIN protection reset at an authorized Mercedes-Benz Center.

User profile



Setting a user profile

Multimedia system:



 System   Personalization

Displaying a user profile when starting

If this function is active, a prompt appears when starting the system asking which user profile to use.



-  Select [Display Profile Selection after Start](#).
-  Activate or deactivate the function.

Selecting a user profile

-  Select [Guest Profile](#) or individual profile ●.
-  Some settings from the user profile are only loaded when the vehicle is stationary or when the ignition is switched on.

Automatic synchronization



Each time the ignition is switched off or on, the individual user profiles are synchronized on the multimedia system and on the server. This ensures that the latest user profiles are always available.

-  Select [Automatic Synchronization](#).
 -  Activate or deactivate the function.
-  For more information about importing/exporting user profiles (→ page 244).

Creating a user profile

Multimedia system:

 System   Personalization
 Create Profile

-  Enter a name.
-  Select .

The following information is saved in the user profile, for example:

- System settings
- Settings in the TV tuner's channel list
- Navigation and traffic information

The settings differ depending on the vehicle equipment.

Importing/exporting user profiles

Requirements:

- There is an Internet connection .
- A Mercedes me account exists at <http://www.mercedes.me>.
- The [Personalization](#) service is active.

Multimedia system:

 System   Personalization
 Manual Export/Import

This function is not available in all countries. Only individual profiles can be imported or exported.

The individual profiles are always collectively imported or exported.

-  **Import:** select [Import Profiles from Server](#). The [The profile data import overwrites all existing profile data. Do you want to continue?](#) message appears.

- ▶ Select **Yes**.
User profiles are imported.
- ▶ **Export:** select **Export Profiles to the Server**.
User profiles are exported.
- ⓘ Certain settings, such as address book entries or previous destinations from the navigation system, are not exported.

Setting user profile options

Multimedia system:

↳ System ▶  Personalization

- ▶ Highlight a profile.
- ▶ Select  options.

The following options are available:

- **Rename**
 - **Delete**
 - **Reset**
- ⓘ The guest profile cannot be deleted or renamed.

Software update

Information on software updates

The multimedia system provides a message when an update is available.

Depending on the source, you can perform various updates:

Software update

Source of the update	Update type
Updates via mobile phone	Navigation map, system updates, Digital Operator's Manual
Updates via an external storage medium, e.g. a USB flash drive	Navigation maps

- ⓘ Updates via mobile phone require an active Internet connection for the vehicle. This is not available in all countries. For further information on connecting to the Internet, see (→ page 294).

Advantages of updating software

Thanks to the software update, your vehicle status is up-to-date.

In order to constantly improve the quality of our services you will receive future updates for your multimedia system, the Mercedes me connect services and your vehicle's communication module. These will conveniently be sent to you via the mobile phone connection in your vehicle and, as an option, installed automatically. You can monitor the status of your updates on the Mercedes me portal and find information about potential innovations.

Your advantages at a glance:

- conveniently receive software updates via the mobile phone network
- improves the quality and availability of Mercedes me connect services
- keeps your multimedia system and communication module up-to-date

Further information about software updates can be found at <http://me.mercedes-benz.com>

Performing a software update

Requirements:

- There is an Internet connection (→ page 294).
- **For automatic updates:** your vehicle has a permanently installed communication module.

Multimedia system:

↳ System ▶ Software Update

Automatic update

- ▶ Switch [Automatic Online Update](#) on . Updates are performed.
- The current status of the updates is displayed.

Manual update

- ▶ Deactivate [Automatic Online Update](#).
- ▶ Select an update from the list and start the update.

Activating the software update

- ▶ Restart the system.

Function of important system updates

Important system updates may be necessary for the security of your multimedia system's data. Please install these updates, or else the security of your multimedia system cannot be ensured.

- ⓘ If automatic software updates are activated, the system updates will be downloaded automatically (→ page 246).

As soon as an update is available for download, a corresponding message appears on the media display.

You have the following selection options:

- [Download](#)
The update will be downloaded in the background.
- [Details](#)
Information about the pending system update is displayed.
- [Later](#)
The update can be downloaded manually at a later time (→ page 246).

If the download is completed and the update is ready for installation, you will be informed of this after the next ignition cycle, for example.

- ⓘ Park the vehicle safely in a suitable location before starting the installation.

Requirements for the installation:

- The ignition is switched on.
- The engine is not running.
- Notes and warnings have been read and accepted.
- The parking brake is applied.

If all requirements are met, the update will be installed. The multimedia system cannot be operated while the update is being installed and vehicle functions are restricted.

If errors should occur during the installation, the multimedia system automatically attempts to restore the previous version. If restoration of the previous version is not possible, a symbol appears on the center console display. Please consult a qualified specialist workshop to resolve the problem.

Reset function

Multimedia system:

↪ System ▶ Reset

Personal data is deleted, for example:

- Station presets
- Connected mobile phones

▶ Select **Yes**.

If PIN protection is activated, a prompt appears asking if you also wish to restore this to the factory settings during a reset.

▶ Select **Yes**.

▶ Enter the current PIN.
The PIN is reset.

or

▶ Select **No**.

The current PIN stays the same after resetting.

- ⓘ If you have forgotten your PIN, an authorized Mercedes-Benz Center can deactivate the PIN protection for you.

A prompt appears again asking whether you really wish to reset.

▶ Select **Yes**.

The multimedia system is reset to the factory settings.

Navigation

Switching navigation on

Multimedia system:

↪ Navigation

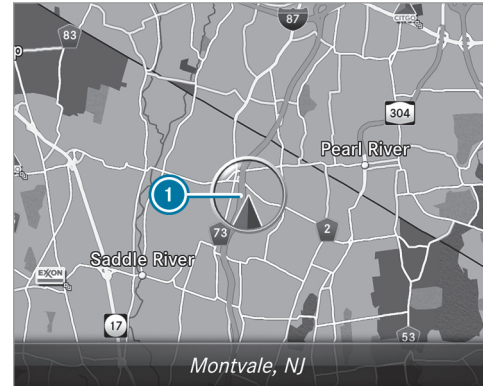

- ▶ Alternatively: press the **NAVI** button.
The map appears and shows current vehicle position ①.

- ❗ If a climate control setting is changed, a climate bar appears briefly.

Showing/hiding the navigation menu

Requirements:

- The map displays the current vehicle position.

Multimedia system:

➔ **Navigation**

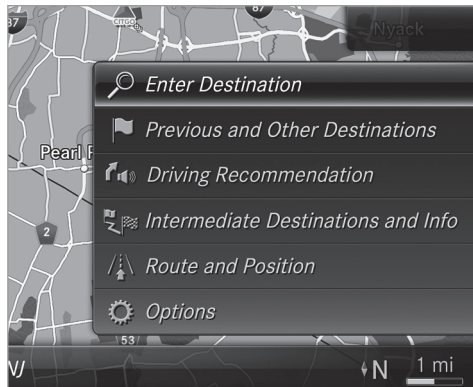

➔ **To show:** swipe left on the touchpad or the Touch Control.

or

➔ Slide the controller to the left.

➔ **To hide:** swipe right on the touchpad or the Touch Control.

or

➔ Slide the controller to the right.

- ❗ To show or hide lower menu levels, swipe or slide to the left or right as many times as necessary.

Destination entry

Entering a POI or address

⚠ WARNING Risk of distraction from information systems and communications equipment

If you operate information and communication equipment integrated in the vehicle when driving, you will be distracted from the traffic situation. This could also cause you to lose control of the vehicle.

- ➔ Only operate this equipment when the traffic situation permits.
- ➔ If you cannot be sure of this, stop the vehicle whilst paying attention to road

and traffic conditions and operate the equipment with the vehicle stationary.

You must observe the legal requirements for the country in which you are currently driving when operating the multimedia system.

Requirements:

- **For the online search:** Mercedes me connect is available.
- You have a user account for the Mercedes me portal.
- The service is available.
- The service has been activated at an authorized Mercedes-Benz Center.

Further information can be found at: <http://www.mercedes.me>

Multimedia system:

Navigation

- ▶ Show the navigation menu.
- ▶ Select  **Enter Destination**.

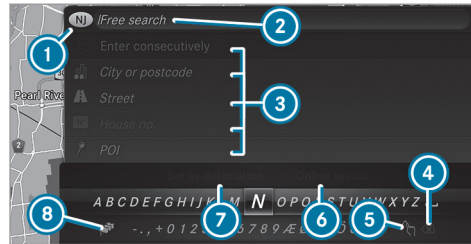

The state or province in which the vehicle is located is set ①.

There are two available methods of destination entry:

- Free search ②
- Search step-by-step ③

Method 1: free search

- ▶ Enter the POI or address in ②. The entries can be made in any order. During destination entry, suggestions are made by the multimedia system. A selection of destinations appears in a list.

Enter these address elements, for example:

- City, street, house number
- Street, city
- ZIP code
- POI name
- POI category, e.g. **Gas Station**
- City, POI name

- ▶ **To switch to handwriting recognition:** select  ⑤.

- ▶ Write the character on the touchpad.

- ▶ **To switch to character selection:** press the  button.

or

- ▶ Press the touchpad.

- ▶ **To delete an entry:** select  ④ (if available).

Use the following options:

- Press briefly: deletes the last character entered or the last suggestion adopted.
- Press and hold: deletes the entire entry.

- ▶ **To set the language:** select  ⑧.

▶ Select the language.

ⓘ This function is useful for countries in which several character sets are supported. An example is Russia, which uses Cyrillic and Latin characters.

▶ **To call up the online search function:** select **Online Search** ⑥.

Once an Internet connection is established, a list appears. It shows online destinations related to the previous entry.

Online destinations are provided by the Internet service provider.

▶ Select the online destination.

or

▶ Enter the online destination or a 3 word address in the input line.

ⓘ Enter a 3 word address (→ page 254). Online search is not available in all countries.

▶ **To call up the list:** press the  button.

or

▶ If the top line of the character bar is highlighted, navigate upwards.

▶ Select the destination in the list.

▶ **To adopt a destination:** select ⑦ **Select Destination**.

If there are several listings for a destination, a list appears.

▶ Select the destination.

The destination address is shown.

Method 2: search step-by-step

▶ Press  button.

or

▶ If the top line of the character bar is highlighted, navigate upwards.

The character bar is hidden. **City or ZIP** is highlighted. Additional entry fields, e.g. for **POI**, are available.

▶ Select **City or ZIP**.

The character bar appears.

▶ Enter the city or the ZIP code.

During destination entry, suggestions are made by the multimedia system. A selection of destinations appears in a list.

The address entries can be made in any order, for example:

- **City or ZIP, Street, House No.**
Enter an intersecting street, if available.
- **Street, City or ZIP**
- **POI, e.g. Gas Station, City or ZIP**

ⓘ During destination entry, use the following functions:

- Switching to handwriting recognition
- Switching to character selection
- Deleting an entry

An entry, e.g. **POI**, can be deleted with  in a step-by-step search. Navigate to the left to do so.

- Calling up the online search function (if available)
- Calling up a list

The functions are described in the free search.

▶ **To change the state/province:** select the state or the province.

- ▶ Enter the state or the province. You only need to enter the first character.
 - ▶ Select the state or the province in the list.
 - ▶ **To change the country:** select the country.
 - ▶ Enter the country. You only need to enter the first character.
 - ▶ Select the country on the list.
 - ▶ **To adopt a destination:** select [Select Destination](#).
- If there are several listings for a destination, a distance-orientated list appears.
- ▶ Select the destination.
The destination address is shown.

Selecting previous destinations

Multimedia system:



- ▶ [Previous and Other Destinations](#)

- ▶ Select [Previous Destinations](#).
- ▶ Select the destination.
The destination address is shown.

or

- ▶ If favourites have been saved already (→ page 263), select [From My Favorites](#).
- ▶ Select the favourite.
The destination address is shown.

Selecting a POI

Multimedia system:



- ▶ [Previous and Other Destinations](#)
- ▶ [POIs](#)

- ▶ Select the category.
- or

- ▶ Select [All Categories](#) and the category.
- If route guidance is not active:** the search begins in the vicinity of the current vehicle position. The list is sorted by distance in ascending order.

The POIs show the following information:

- name of POI
- linear distance to the POI
- the direction of the linear distance to the POI (arrow) is displayed when searching for the vehicle's current position

- ▶ Select the POI.
- ▶ **Route guidance is active:** select the search position prior to choosing a POI (see example).
- ▶ If intermediate destinations are set, these can also be selected as the search position after selecting [Near Destination](#).

Filtering displays for POIs

- ▶ Enter the search term in [Search:](#).
The results list shows relevant POIs.
- ▶ Select [ok](#).
The first POI in the list is highlighted.
- ▶ Select the POI.

Example: setting the search position for the parking category during active route guidance

- ▶ Select [In the Vicinity](#), [Near Destination](#) or [Along the Route](#).
The list shows the located POIs or opens an overview of the route destination after selecting [Near Destination](#).
- ▶ Select the POI.

- ▶ Select **Near Destination**: select the intermediate destination or the destination.

Starting an automatic gas station search

Requirements:

- The automatic gas station search is activated (→ page 257).

Driving situation

Route guidance is active. The fuel level in the fuel tank reaches the reserve fuel level.

The **Reserve Fuel Do you want to start a search for surrounding gas stations?** message is shown.

- ▶ Select **Yes**.
The automatic gas station search begins. The available gas stations along the route or in the vicinity of the vehicle's current position are displayed.
- ▶ Select the gas station.
The address of the gas station is displayed.
- ▶ If route guidance is not active, select **Start Route Guidance**.
The selected gas station is set as the destination. Route guidance begins.

or

- ▶ If route guidance is active, select **Start New Route Guidance** or **Set as Next Way Point**.
Start New Route Guidance: the selected gas station is set as a new destination. The previous destinations and intermediate destinations are deleted. Route guidance to the gas station begins.

Set as Next Way Point: the selected gas station is set as the next intermediate destination. Route guidance begins.

- ▶ **If there are already four intermediate destinations**: select **Yes** in the prompt.
The selected gas station is entered into position 1 of the intermediate destinations menu. Intermediate destination 4 is deleted. Route guidance begins.

Entering an intermediate destination

Requirements:

- A destination is entered.

Multimedia system:

 **Navigation**  **Way Points and Info**

- ▶ Select **Search for Way Point**.
- ▶ Enter the intermediate destination as a POI or address (→ page 248).
- ▶ Select the intermediate destination.
- ▶ Select **Set as Destination**.

or

- ▶ Select an intermediate destination using  **Enter Destination** during route guidance.
- ▶ Select **Set as Next Way Point** after entering the destination.

Editing intermediate destinations



Requirements:

- The destination and at least one intermediate destination have been entered.

Multimedia system:

 **Navigation**  **Way Points and Info**

- ▶ **To call up the map**: highlight the destination or the intermediate destination.

- ▶ Select  **Map** .
- ▶ Move the map (→ page 268).
- ▶ Select destination on the map (→ page 254).
- ▶ **To change the order of destinations:** highlight the destination or the intermediate destination.
- ▶ Select  **Move** .
- ▶ Move the intermediate destination to the desired position.
- ▶ Press the Touch Control, the controller or the touchpad.
- ▶ **To delete a destination:** highlight the destination or the intermediate destination.
- ▶ Select  **Delete**.

Calculating a route with intermediate destinations

Requirements:

- The destination and at least one intermediate destination have been entered.

Multimedia system:

↳ **Navigation** ▶ **Way Points and Info**

- ▶ Select **Start New Route Guidance**.
The route is calculated with the set intermediate destinations.

Selecting a contact for destination entry

Requirements:

- A mobile phone is connected to the multimedia system (→ page 275).
- Contacts have been downloaded (→ page 280).

Multimedia system:

↳ **Navigation**

▶▶  **Previous and Other Destinations**
▶▶ **Contacts**

- ▶ Select the contact.
The contact details are displayed.
- ▶ Select the address.

Filtering displays for contacts

- ▶ Enter a name or telephone number, for example, into the search field.

▶ Select .

- ▶ The first contact in the list is highlighted.
- ▶ Select the contact.
- ▶ Select the address.

Entering geo-coordinates

Multimedia system:

↳ **Navigation**

▶▶  **Previous and Other Destinations**
▶▶ **Geo-coordinates**

- ▶ Enter geo-coordinates as latitude and longitude coordinates in degrees, minutes and seconds.
The map shows the position.
- ▶ Confirm the entry.
- ▶ **To calculate a route:** select **Start Route Guidance**.
- ▶ If a route has already been created, select **Start New Route Guidance** or **Set as Way Point**.

Entering the destination as a 3 word address

Requirements:

- Searching for a destination using 3 word addresses is possible in the online search (→ page 248).
- There is an Internet connection.

 Searching for a destination using 3 word addresses is not possible in all countries.

Multimedia system:

 **Navigation**  **Enter Destination**

- ▶ Select **Online Search**.
- ▶ Enter the destination address as a 3 word address. Separate each of the words with a full stop.
The search results are displayed.
- ▶ Select the destination in the list.
The destination address is shown. The route can be calculated.

 3 word addresses from what3words are an alternative addressing system for multilingual georeferencing of global locations with a resolution of three meters. Using this grid,

locations on the Earth's surface are included which do not have a building address such as street and house number, for example.

The Empire State Building in New York has the following language dependent 3 word address, for example:

- English: **parade.help.bleat**
- French: **commun.verbe.bisquer**
- Spanish: **suertes.diga.pesca**

3 word addresses are unique, easy to remember and suffice for most routine applications.

The bidirectional conversion of 3 word addresses can be carried out here:

- at the website <http://what3words.com>
- in the what3words apps

Selecting a destination on the map

Multimedia system:

 **Navigation**  **Options**

- ▶ Select **Map Menu**.

or

- ▶ If the map is displayed in full screen mode, press the central control element.
The map menu appears.

- ▶ Select "move map" in map menu  (→ page 266).

- ▶ Swipe in any direction on the Touch Control or touchpad.

or

- ▶ Slide the controller in any direction.
The map moves in the corresponding direction under the crosshair. The more you move your finger away from the starting position on the touchpad, the faster the map moves.
- ▶ Press the Touch Control, the controller or the touchpad.
If several destinations are located around the crosshair, a list shows the available POIs and roads.

If a destination is located exactly on the crosshair, the destination address is displayed.

- ▶ Select the destination in the list.
The destination address is shown.

Setting the map orientation to 2D or 3D

- ▶ Highlight [Map Orientation: 2D/3D](#).
- ▶ Press the Touch Control, the touchpad or the controller.
The map will be displayed in the selected map orientation.

Showing traffic messages in the vicinity of the map

- ▶ Select [Traffic Messages for the Vicinity](#).
The map appears.
- ▶ Swipe left or right on the touchpad.

or

- ▶ Slide the controller to the left or right.
The previous or next traffic incident is highlighted on the map. Information on the traffic incident is displayed.

- ⓘ Traffic reports are not available in all countries.

Showing POIs in the vicinity of the map

- ▶ Select [POIs in the Vicinity](#).
- ▶ Swipe left or right on the touchpad.

or

- ▶ Slide the controller to the left or right.
The previous or next POI is highlighted on the map. The name or the address is shown.
- ▶ **To filter the display by POI category:**
swipe down on the Touch Control or the touchpad.

or

- ▶ Slide the controller down.
- ▶ Select the POI category.

- ⓘ [User Defined](#) allows personal POI symbols to be selected (→ page 268).

Route

Calculating a route

Requirements:

- The destination has been entered.
 - The destination address is shown.
- ▶ If route guidance is not active, select [Start Route Guidance](#).
The route to the destination is calculated. The map shows the route. Route guidance then begins.





or

- ▶ If route guidance is active, select [Start New Route Guidance](#) or [Set as Next Way Point](#).
[Start New Route Guidance](#): the selected destination address is set as a new destination. The previous destinations and intermediate destinations are deleted. Route guidance to the new destination begins.
[Set as Next Way Point](#): the selected destination address is set as the next intermediate destination. Route guidance begins.

Taking alternative routes into consideration

- ▶ Select an alternative route (→ page 257).

Other menu functions

- ▶ **To save the destination:** select  [Store in "Previous Destinations"](#).
- ▶ **To display on the map:** select  [Map](#).
- ▶ **To call a telephone number:** select  [Call](#) (if available).
- ▶ **To call up an Internet address:** select  [www](#) (if available).

Selecting a route type

Multimedia system:

 Navigation  Route and Position

▶ Select [Route Settings](#).

▶ Select the route type.

If route guidance is active, the new route is calculated with the new route type.

If route guidance is not active, the next route is calculated with the new route type.

You can choose from the following route types:

- [Eco Route](#)

An economical route is calculated. The journey time may be somewhat longer than for quicker routes.

The symbol for the current vehicle position is displayed in green.

- [Fast Route](#)

A route with a quick journey time is calculated.

- [Short Route](#)

A route with a short driving distance is calculated.

[Automatic Traffic Jam Avoidance](#) can be switched on or off for these route types. If [Automatic Traffic Jam Avoidance](#) is switched on, [Ask in the Event of Traffic Jam Avoidance](#) can be selected.

The [Automatic Traffic Jam Avoidance](#) and [Ask in the Event of Traffic Jam Avoidance](#) settings are not available in every country.

The settings enable the following:

- [Automatic Traffic Jam Avoidance](#)

The route is calculated with the currently set route type.

Traffic reports via Live Traffic Information are taken into account.

Live Traffic Information is not available in all countries.

- [Ask in the Event of Traffic Jam Avoidance](#)

A prompt appears when a new route is detected with a shorter journey time based on traffic reports. You can continue to use the current route or use the dynamic route instead.

Selecting route options

Multimedia system:

 Navigation  Route and Position
▶▶ [Avoid Options](#)

Avoiding areas

▶ Select [Areas](#) (→ page 269).

Avoiding highways, ferries, motorail trains, tunnels, unpaved roads

▶ Select or deselect avoid option.

Using toll roads

▶ Select [Use Toll Roads](#).

▶ Select [Cash](#) or [Electronic Billing](#) or [Off](#).

The route takes into account roads that require the payment of a usage fee (toll).

If [Off](#) is selected, toll roads are not taken into account.

The selected route options cannot always be implemented. Therefore, a route may include a ferry, for instance, even though the avoid [Ferries](#) option is enabled. A message appears and you will hear a corresponding message.

Using carpool lanes

- ▶ Select **Number of Occupants in the Vehicle**.
- ▶ Select number.
When using carpool lanes, observe the applicable legal requirements as well as any conditions pertaining to when and where such lanes may be used. Carpool lanes may only be used if certain conditions are met.

These route options are not available in every country.

Selecting notifications

Multimedia system:

↳ **Navigation** ▶  **Options**
▶ **Announcements**

- ▶ Switch an announcement on or off .
- You can choose from the following announcements:

- **Announce Traffic Warnings**
This function is not available in all countries.
- **Announce Street Names**

The multimedia system announces the names of the roads that will follow the upcoming change of direction.

This function is not available in all countries and languages.

Displaying destination information

Requirements:

- A destination is entered.

Multimedia system:

↳ **Navigation**

- ▶ Select **Way Points and Info**.

The following information is displayed:

- Intermediate destinations and destination
The route can also include up to four intermediate destinations.
- Name, address
- Remaining driving distance
- Time of arrival

Selecting an alternative route

Multimedia system:

↳ **Navigation** ▶  **Route and Position**

- ▶ Select **Alternative Route**.
The routes are displayed in accordance with the setting made in the route settings.
The currently selected route is shown with a dark blue line.
- ▶ Select the alternative route.

Switching the automatic gas station search on/off

Multimedia system:

↳ **Navigation** ▶  **Options**

- ▶ Switch **Reserve Fuel** on or off .
- Switched on : when the fuel reserve level is reached, a prompt appears asking whether you want to start searching for gas stations.

Using automatic gas station search

Requirements:

The automatic gas station search is activated (→ page 257).

The prompt **Reserve Fuel Do you want to start a search for surrounding gas stations?** appears.

- ▶ Select **Yes**.
The automatic gas station search begins. The available gas stations along the route or in the vicinity are displayed.
- ▶ Select the gas station.
- ▶ When there is no route, the gas station is set as the destination.

or

- ▶ When there is a route, the gas station is set as the next intermediate destination.

Starting the automatic service station search

Requirements:

- ATTENTION ASSIST and the **Suggest Rest Area** function are activated (→ page 191).

Driving situation

The **ATTENTION ASSIST Do you want to search for a rest area?** message is shown.

- ▶ Select **Yes**.
The service station search starts. The available service stations along the route or in the vicinity of the vehicle's current position are displayed.
- ▶ Select the service station.
The service station address is displayed.
- ▶ If route guidance is not active, select **Start Route Guidance**.
The selected service station is set as a destination. Route guidance begins.

or

- ▶ If route guidance is active, select **Start New Route Guidance** or **Set as Next Way Point**.
Start New Route Guidance: the selected service station is set as a new destination. The previous destination and all intermediate destinations are deleted. Route guidance to the service station begins.
Set as Next Way Point: the selected service station is set as the next intermediate destination. Route guidance begins.

Route guidance

Notes on route guidance

⚠ WARNING Risk of distraction from operating integrated communication equipment while the vehicle is in motion

If you operate communication equipment integrated in the vehicle when driving, you will be distracted from the traffic situation. This could also cause you to lose control of the vehicle.

- ▶ Only operate this equipment when the traffic situation permits.
- ▶ If you cannot be sure of this, stop the vehicle whilst paying attention to road and traffic conditions and operate the equipment with the vehicle stationary.

You must observe the legal requirements for the country in which you are currently driving when operating the multimedia system. Route guidance begins once a route has been calculated.

The road and traffic rules and regulations always have priority over multimedia system driving instructions.

The following driving instructions can be used:

- Navigation announcements
- Route guidance displays
- Lane recommendations

If you do not follow the driving instructions or if you leave the calculated route, a new route is calculated automatically.

Driving instructions may differ from the actual road and traffic conditions if:

- The route is diverted
- The direction of a one-way street has been changed

For this reason, you must always observe road and traffic rules and regulations during your journey as well as the prevailing traffic conditions.

The route may differ from the ideal route due to the following:

- Roadworks

- Incomplete digital map data

Notes on GPS reception

The correct function of the navigation system depends amongst other things on GPS reception. In certain situations GPS reception can be impaired, defective or even not possible, e.g. in tunnels or in parking garages.

Changing direction overview

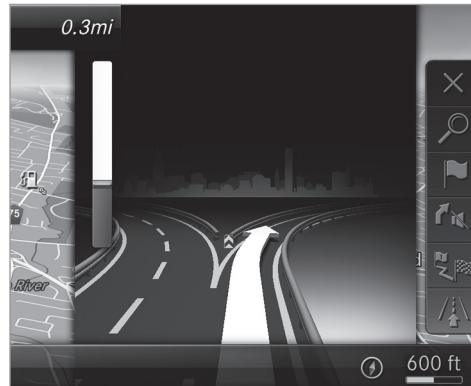

There are three phases when changing direction:

- Preparation phase

If there is enough time between the changes of direction, the multimedia system prepares you for the upcoming change of direction. A navigation announcement is issued, e.g. "Prepare to turn right".

The map appears in full-screen mode.

- Announcement phase

The multimedia system announces the upcoming change of direction, e.g. by announcing "Turn right in 300 ft (100 m)".

The display is split into two parts. The map is displayed on the left; on the right, there is a detailed image of the intersection or a 3D image of the upcoming change of direction.

- Change-of-direction phase

The multimedia system announces the imminent change of direction, e.g. by announcing "Now turn right".

The display is split into two parts.

The vehicle has successfully changed direction when the light-color bar on the right

drops down to 0 feet (0 m) and the current vehicle position symbol has reached the highlighted change-of-direction point.

When the change of direction is complete, the map appears in full-screen mode.

- Changes of direction are also shown in the Instrument Display.

Lane recommendations overview

This display appears for multi-lane roads.

If the digital map contains the relevant data, the multimedia system can display lane recommendations for the next two changes of direction.



- 1 Recommended lane
- 2 Possible lane
- 3 Lanes not recommended

The following lanes are displayed:

- Recommended lane 1
 - In this lane, you will be able to complete both the next change of direction and the one after that.

- Possible lane 2
 - In this lane, you will only be able to complete the next change of direction.
- Lane not recommended 3
 - In this lane, you will not be able to complete the next change of direction without changing lane.

During the change of direction, new lanes may be added.

- Lane recommendations can also be displayed in the Instrument Display and in the Head-up Display.

Overview of destination reached

Once the destination is reached, you will see the  checkered flag. Route guidance is finished.

When an intermediate destination has been reached, you will see the intermediate destination flag with the number of your  intermediate destination. After this, route guidance is continued.

Switching navigation announcements on/off

Requirements:



- Route guidance is active.

▶ **To switch off:** press the volume control on the multifunction steering wheel during a navigation announcement (→ page 233).

or

▶ Press the volume control on the center console during a navigation announcement (→ page 233).
The **Voice Guidance has been deactivated.** message appears.

or

▶ Show the navigation menu (→ page 248).
▶ Select  **Voice Guidance**.
The symbol changes to .
▶ **To activate:** select  **Voice Guidance**.
The current navigation announcement is played.

ⓘ In the following situations, navigation announcements are switched on automatically:

- A new route guidance is started.
- The route is recalculated.

ⓘ You can add and call up this function as a favorite under **Voice Guidance On/Off**.

Switching navigation announcements on/off during a phone call

- ▶ Select **System**.
- ▶ Select  **Audio**.
- ▶ Select **Navigation and Traffic Announcements**.
- ▶ Switch **Voice Guidance During Call** on or off .

Adjusting the volume of navigation announcements

Requirements:

- Route guidance is active.
- ▶ **On the multifunction steering wheel or on the multimedia system:** turn the volume

control on the multifunction steering wheel during a navigation announcement.



or

▶ Turn the volume control on the center console during a navigation announcement (→ page 233).

ⓘ In the following situations, the volume is raised to the maximum volume or lowered to the minimum volume:

- A new route guidance is started.
- The route is recalculated.

ⓘ The minimum volume can be individually set at an authorized Mercedes-Benz Center.

- ▶ **Via system settings:** select **System**.
- ▶ Select  **Audio**.
- ▶ Select **Navigation and Traffic Announcements**.
- ▶ Select **Voice Guidance Volume**.
- ▶ Set the volume.
- ▶ **To switch audio fadeout on/off during navigation announcements:** select **System**.
- ▶ Select  **Audio**.

- ▶ Select [Navigation and Traffic Announcements](#).
- ▶ Switch [Audio Fadeout During Voice Guidance](#) on or off .



Repeating navigation announcements

Requirements:

- A route has already been created.
- Route guidance is active.

Multimedia system:

↳ [Navigation](#)

- ▶ Select  [Voice Guidance](#) .
 - ▶ Select  [Voice Guidance](#) .
The current navigation announcement is repeated.
-  You can add and call up this function as a favorite under [Repeat Voice Guidance](#).

Canceling route guidance

Requirements:

- A route has already been created.
- Route guidance is active.

Multimedia system:

↳ [Navigation](#)

- ▶ Select  [Cancel Route Guidance](#).

Overview of route guidance to an off-road destination

An off-road destination is within the digital map. The map contains no roads that lead to the destination.

You can enter geo-coordinates or a three word address for off-road destinations on the map. Route guidance guides you for as long as possible with navigation announcements and displays on roads that are known to the multimedia system.

Shortly before you reach the last known position on the map, you will hear the "Please follow the direction arrow" announcement. The display shows a direction arrow and the linear distance to the destination.

Overview of route guidance from an off-road location to a destination

Off-road position: the current vehicle position is located within the digital map on roads that are not available.

When route guidance begins the following displays appear:

- The [Road Not Mapped](#) message is shown.
- A direction arrow showing the linear direction to the POI.

When the vehicle is back on a road known to the multimedia system, route guidance continues as normal.

Overview of off-road status during route guidance

Due to roadworks, for example, there may be differences between the data on the digital map and the actual course of the road. In such cases, the multimedia system will temporarily be unable to locate the vehicle's current position on the digital map. The vehicle is off-road.

When the vehicle is off-road, the following displays are shown:

- the **Road Not Mapped** message
- a direction arrow showing the linear direction to the POI

When the vehicle is back on a road known to the multimedia system, route guidance continues as normal.

Destination

Saving the current vehicle position

Multimedia system:

Navigation

- ▶ If the map is displayed in full screen mode, press the central control element. The map menu appears.
- ▶ Select ❶ on the map menu (→ page 266). The current vehicle position is saved to the "Previous destinations" memory.

Storing a map position

Multimedia system:

Navigation

The map is in full-screen mode.





- ▶ Press the Touch Control, the controller or the touchpad.
- ▶ Select "move map" in map menu ❷ (→ page 266).
- ▶ Select a position on the map. If multiple entries are available for a map position, a list appears.
- ▶ Highlight an entry.
- ▶ Select  **Store in "Previous Destinations"**. The map position is saved to the "Previous destinations" memory.

Editing the previous destinations

Multimedia system:

Navigation

- ▶▶  **Previous and Other Destinations**
- ▶▶ **Previous Destinations**
- ▶ Highlight one of the previous destinations.

- ▶ **To save as a favorite:** select  **Save My Favorite**. The favorites are displayed.
- ▶ Move the favorite to the desired position. If a favorite has already been added at this position, it will be overwritten.
- ▶ **To save as "Home" address:** select  **Save as "Home"**.
- ▶ **To save as "Work" address:** select  **Save as "Work"**.
- ▶ **To delete a single or all destinations:** select  **Delete** or **Delete All**. A prompt appears.
- ▶ Select **Yes**.
- ▶ **To display destination information:** select  **Details**.

Using external destinations

External destinations can be received from the following sources:

- Mercedes-Benz Apps
- Door-to-door navigation with Companion app (USA)

- Received destinations are saved in the previous destinations.

A prompt appears on the media display.

- A destination has been received without picture information:** select [Yes](#).

- If route guidance is not active, select [Start Route Guidance](#).

The route to the destination is calculated. The map shows the route. Route guidance then begins.

or

- If route guidance is active, select [Start New Route Guidance](#) or [Set as Next Way Point](#). [Start New Route Guidance](#): the received destination address is set as a new destination. The previous destinations and intermediate destinations are deleted. Route guidance to the new destination begins.

[Set as Next Way Point](#): the received destination address is set as the next intermediate destination. Route guidance begins.

- A destination has been received with picture information:** select [Start Route Guidance](#).
Route guidance starts.

[Route guidance with current traffic reports](#)

Traffic information overview

Traffic reports are received using Live Traffic Information and are used for route guidance.

This service is unavailable in some countries.

There may be differences between the traffic reports received and the actual road and traffic conditions.

Important information on Live Traffic Information:

- Current traffic reports are received via the Internet connection.
- The traffic situation is updated at short, regular intervals.
- The subscription information shows the status (→ page 264).

Information on the vehicle's position is regularly sent to Daimler AG. The data is immediately rendered anonymous by Daimler AG and forwarded to the traffic data provider. Using this data, traffic reports relevant to the vehicle's position are sent to the vehicle. The vehicle acts as a sensor for the flow of traffic and helps to improve the quality of the traffic reports.

If you do not wish to transmit your vehicle position, you can have this service deactivated at an authorized Mercedes-Benz Center.

Displaying subscription information

Requirements:

- The vehicle is equipped with Live Traffic Information.

Multimedia system:

[Navigation](#) [Options](#)

The subscription expiration date is automatically displayed:

- one month before the expiration date.
- one week before the expiration date.
- on the expiration date.

▶ **To display manually:** select [Live Traffic Subscription Info](#).

Depending on the status, one of the following messages appears:

- the period of validity for the subscription is displayed.
- the subscription has expired.

① The subscription can be extended:

- at an authorized Mercedes-Benz Center
- via an MB Info call to the Mercedes-Benz Customer Assistance Center

Displaying the traffic map

Requirements:

- For Live Traffic Information: the vehicle is equipped with a communication module featuring an activated, integrated SIM card.
- When the vehicle is started, the communication module automatically establishes an Internet connection. Traffic information is made available shortly afterwards.

Multimedia system:

↳ [Navigation](#) ▶▶  [Options](#)

▶▶ [Map Menu](#)

▶ Alternatively: if the map is displayed in full screen mode, press the Touch Control, the controller or the touchpad. The map menu appears.

▶ Activate  .

The traffic map shows the following information, for example:

- traffic incidents, for example:
 - roadworks
 - road blocks
 - warning messages

The symbols for traffic incidents are displayed in color (on the route) or gray (off the route).

- traffic flow information:
 - traffic jam (red line)
 - slow-moving traffic (orange line)
 - heavy traffic (yellow line)

- free-flowing traffic (green line)
- display for traffic delays on the route lasting at least one minute
- warning message symbols:
 -  symbol
 - additional road safety notes when approaching a traffic incident, e.g. the end of a traffic jam

If the vehicle approaches a danger area on the route, a warning message is displayed on the map. A warning message may also be issued (→ page 266).

Displaying traffic incidents

Multimedia system:

↳ [Navigation](#) ▶▶  [Options](#)

▶▶ [Map Content](#)

▶ Activate [Traffic Incidents](#). Roadworks, road blocks, local area reports (e.g. fog) and warning messages are displayed.

Activating free flow and traffic display

- ▶ Activate **Free Flowing Traffic** and **Traffic Delays**.

i The traffic delay is displayed for the current route. Traffic delays lasting one minute or longer are taken into consideration.

Displaying details

- ▶ Displays the traffic map (→ page 265).
- ▶ Moves the map (→ page 268).
- ▶ When a traffic report symbol is under the crosshair, press on the central control element. The traffic report details are displayed.

or

- ▶ Press on the central control element.
- ▶ Select **Information on Traffic Reports**. The map shows the traffic report symbols in the vicinity.

Traffic report information is displayed in the status line:

- Traffic report symbol

- Reason for the traffic report, e.g. traffic congestion

- Warning message (highlighted in red)

▶ **To select a traffic report symbol:** select **Next** or **Previous**.

▶ Press on the central control element. The traffic report details are displayed.

Issuing hazard warnings

Multimedia system:

↳ **Navigation** ▶  **Options**

▶ **Announcements**

- ▶ Activate **Announce Traffic Warnings**. Warning messages are issued and tailbacks which pose a risk are announced.

Map and compass

Map and compass overview

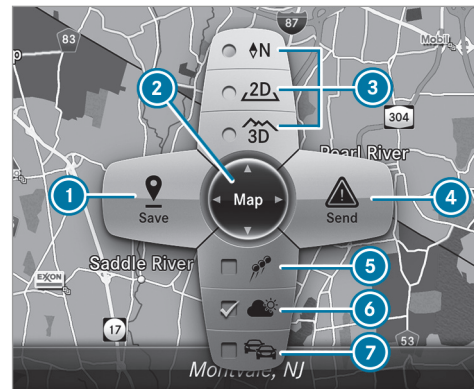

- ① Saves the current vehicle position
- ② Moves the map
- ③ Selects the map orientation and map view
- ④ Selects the function depending on the equipment:
 - Sends a hazard warning via Car-to-X.

- Filters the display of POIs in the vicinity according to POI category
- ⑤ Switches the display of personal POI symbols on the map on or off
- ⑥ Switches one of the following displays on or off depending on the equipment:
 - Weather information
 - Satellite map
 - Traffic incidents
- ⑦ Switches the traffic map display on or off

The map and satellite images are shown in globe projection. This allows for a realistic map display in all map scales. The map uses elevation modeling.

Depending on the map data, important buildings in many cities are depicted realistically on the map in small map scales (e.g. 1/32 mi (20 m), 1/16 mi (50 m)). Other buildings are shown as models.

- ① You can set the unit of measurement of the map scale (→ page 242).

If online information is available, fuel prices and the availability of parking spaces in parking garages are displayed, for example.

- ① Requirements:
 - Mercedes me connect is available.
 - You have a user account for the Mercedes me portal.
 - The service has been activated at an authorized Mercedes-Benz Center.

Further information can be found at: <http://www.mercedes.me>

- ① The online information is not available in all countries.

If **Display in COMAND** is activated in Traffic Sign Assist (→ page 193), speed limits and overtaking restrictions are displayed on the map.

- ① Company logos displayed on the map are trademarks of the respective companies and used solely for the purpose of indicating the locations of these companies. The use of such logos on the map does not indicate approval of, support of or advertising by

these companies for the navigation system itself.

Setting the map scale

Requirements:

- The map is shown.

Multimedia system:

→ Navigation

- ▶ **To zoom in:** swipe down on the Touch Control.

or

- ▶ Turn the controller counter-clockwise.

or

- ▶ Move two fingers apart on the touchpad.
- ▶ **To zoom out:** swipe up on the Touch Control.

or

- ▶ Turn the controller clockwise.

or

- ▶ Move two fingers together on the touchpad.

- ① You can set the unit of measurement of the map scale (→ page 242).

Moving the map

Multimedia system:

Navigation ► Options

► Map Menu

- Alternatively, if the map is displayed in full screen mode, press the central control element. The map menu appears.
- Select "Move map" in map menu ② (→ page 266).
- Swipe in any direction on the Touch Control or touchpad.

or

- Slide the controller in any direction. The map moves in the corresponding direction under the crosshair. The further you move your finger away from the starting position on the touchpad, the faster the map moves.

Selecting the map orientation

Multimedia system:

Navigation ► Options

► Map Menu

- Alternatively, if the map is displayed in full screen mode, press the central control element. The map menu appears.
- In map menu ③, select **N**, **2D** or **3D**(→ page 266).
 - **N**: the 2D map view is displayed so that north is always at the top.
 - **2D**: the 2D map view is aligned to the direction of travel.
 - **3D**: the 3D map view is aligned to the direction of travel.

Selecting POI symbols

Multimedia system:

Navigation ► Options

► Map Content

POIs include gas stations and hotels which can be displayed as symbols on the map, for example. Not all POIs are available everywhere.

- Select **POI Symbols**. The ● dot indicates the current setting. **Standard** displays symbols of predefined categories on the map. **User Defined** allows you to personally select the symbols for the available categories. **None** switches the display off.
- Select a setting.
- **User Defined**: select categories. The POI symbols of the selected categories are displayed or not displayed .

Selecting the display of text information in the map

Multimedia system:

Navigation ► Options

► Text Information

- Select text information. **Current Street** shows the street you are currently driving on at the bottom of the display. When the map is moved, the following information appears under the crosshair:
 - Street name

- POI name
- Area name

Geo-coordinates displays the following information:

- Longitude and latitude
- Elevation

The elevation shown may deviate from the actual elevation.

- Number of satellites from which a signal can be received

When the map is moved, this information does not appear.

Climate Control displays the current climate control settings.

None switches the display off.

Displaying the next intersecting street

Requirements:

- Route guidance is not active.

Multimedia system:

↳ **Navigation** >>  **Options**

- ▶ Activate **Next Intersecting Street**.
The name of the next intersecting street will be displayed at the upper edge of the display.

Displaying the map version

Multimedia system:

↳ **Navigation** >>  **Options**

- ▶ Select **Map Version**.
- ▶ Select **Details**.
- ▶  Information about new versions of the digital map can be obtained from an authorized Mercedes-Benz Center.

Overview of avoiding an area

You can define areas along a route that you would like to avoid.

The route can include an area that is to be avoided in the following situations:

- the destination is located in an area that is to be avoided
- if freeways are located within the area that is to be avoided

Freeways are always taken into account for the route.

- there is no sensible alternative route

Avoiding a new area

Multimedia system:

↳ **Navigation** >>  **Route and Position**
>> **Avoid Options** >> **Areas**

- ▶ Select **Avoid New Area**.
 - ▶ **To search for an area via the map:** select **Using Map**.
 - ▶ Move the map
- or

- ▶ **To search for an area using an address:** select **Address Entry**.
- ▶ Enter the address.
- ▶ Select **Select Destination**.
The map appears.
- ▶ **To display an area:** press the Touch Control, the touchpad or the controller.
A red rectangle appears. This designates the area that should be avoided.

▶ **To change the size of the area:** swipe up or down on the Touch Control or the touchpad.

or

▶ Slide the controller up or down. The map scale is enlarged or reduced and changes the size of the area.

▶ **To set the area:** press the Touch Control, the touchpad or the controller. The area is entered into the list.

Changing an area

Multimedia system:

↳ Navigation ▶  Route and Position
 ▶ Avoid Options ▶ Areas

▶ Highlight an area in the list.

▶ Select  Edit.

Moving the area on the map

▶ Swipe in any direction on the Touch Control or touchpad.

or

▶ Slide the controller in any direction.

Changing the size of the area

▶ **To start:** press the Touch Control, the touchpad or the controller.

▶ **To change:** swipe up or down on the Touch Control or the touchpad.

or

▶ Slide the controller up or down.

▶ **To stop:** press the Touch Control, the touchpad or the controller.

Taking the area for the route into account

▶ Avoid an area in the list. If route guidance is active, a new route is calculated.

If there is no route yet, the setting is carried over to the next route guidance.

Deleting one or all areas

Multimedia system:

↳ Navigation ▶  Route and Position
 ▶ Avoid Options ▶ Areas

▶ Highlight an area in the list.

▶ Select  Delete or  Delete All.

▶ Confirm the prompt with **Yes**. One or all areas are deleted.

Map data update overview

Updating at the authorized Mercedes-Benz Center

The digital maps generated by the map software become outdated in the same way as conventional road maps. Optimal route guidance can only be provided by the navigation system in conjunction with the most up-to-date map data. Information about new versions of the digital map can be obtained from an authorized Mercedes-Benz Center.

You can receive updates to the digital map there.

Online map update

The online map update service from Mercedes me connect can be used to update map data.

 The online map update service is not available in all countries.

The following options are available for the update:

- the automatic map update updates map data for one region.

For automatic map updates [Automatic Online Update](#) must be activated in the system settings (→ page 246).

- the manual map update updates map data for several or all regions.

Further information on the online map update is available at an authorized Mercedes-Benz Center or at <http://www.mercedes.me>.

Further information on updates: http://manuals.daimler.com/baix/cars/connectme/en_GB/index.html.

Overview of map data

Your vehicle is supplied with map data at the factory. Depending on the country, map data for your region is either pre-installed or the map data is supplied on a data storage medium.

If the map data on your vehicle has been installed at the factory and you wish to reinstall it, you do not need to enter the activation code.

For map data that you have purchased in the form of a data storage medium, you must enter the accompanying activation code.

- ⓘ If you save the map data on a data storage medium with the online map update service, no entry is required. The activation code is stored on the data storage medium during the downloading process.

Observe the following when entering the activation code:

- The activation code can be used for one vehicle
- The activation code is not transferable
- The activation code has six digits

In the event of the following problems, please contact an authorized Mercedes-Benz Center:

- The multimedia system does not accept the activation code
- You have lost the activation code

Displaying the compass

Multimedia system:

→ [Navigation](#) →  [Route and Position](#)

▶ Select [Compass](#).

The compass display shows the following information:

- the current direction of travel with bearing (360° format) and compass direction
- longitude and latitude coordinates in degrees, minutes and seconds
- height (rounded)
- number of GPS satellites from which a signal can be received

Setting the map scale automatically

Multimedia system:

→ [Navigation](#) →  [Options](#)

The map scale is set automatically depending on your driving speed.

For journeys in cities with detailed city models, a map view from the driver's perspective is used.

▶ Switch [Auto Zoom](#) on or off .

-  The automatically selected map scale can be changed manually for a short time. The setting is reset automatically after a few seconds.

Displaying the satellite map



Multimedia system:

 **Navigation**   **Options**

 **Map Content**

-  Switch **Satellite Map** on or off .

or

-  If satellite map display  is available in the map menu, switch it on or off (→ page 266).
Switched on : satellite maps are displayed in map scales of 2 mi (2 km) or less.
Switched off : satellite maps are not displayed in map scales from 2 mi (2 km) to 10 mi (10 km).

-  Satellite maps for these map scales are not available in all countries.

Displaying weather information

Requirements:

- Mercedes me connect is available.
- You have a user account for the Mercedes me portal.
- The service is available.
- The service has been activated at an authorized Mercedes-Benz Center.

Further information can be found at: <http://www.mercedes.me>



Multimedia system:

 **Navigation**   **Options**

 **Map Content**

-  Activate **Weather Information** .

or

-  If weather information display  is available in the map menu, activate (→ page 266) it.
Current weather information is displayed on the navigation map, e.g. temperature or cloud cover.

-  Weather information is not available in all countries.

Calling up the Digital Operator's Manual (navigation)

Calling up information on navigation

Multimedia system:

 **Navigation**   **Options**

 **Navigation Info**

-  Select the topic.

Telephone

Telephony

Notes on telephony

-  **WARNING** Risk of distraction from operating integrated communication equipment while the vehicle is in motion

If you operate communication equipment integrated in the vehicle when driving, you will be distracted from the traffic situation.

This could also cause you to lose control of the vehicle.

- ▶ Only operate this equipment when the traffic situation permits.
- ▶ If you cannot be sure of this, stop the vehicle whilst paying attention to road and traffic conditions and operate the equipment with the vehicle stationary.

⚠ WARNING Risk of distraction from operating mobile communication equipment while the vehicle is in motion

If you operate mobile communication equipment when driving, you will be distracted from the traffic situation. This could also cause you to lose control of the vehicle.

- ▶ Only operate this equipment when the vehicle is stationary.



You must observe the legal requirements for the country in which you are currently driving when operating mobile communication equipment in the vehicle.

Further information can be obtained from an authorized Mercedes-Benz Center or at: <http://www.mercedes-benz.com/connect>.

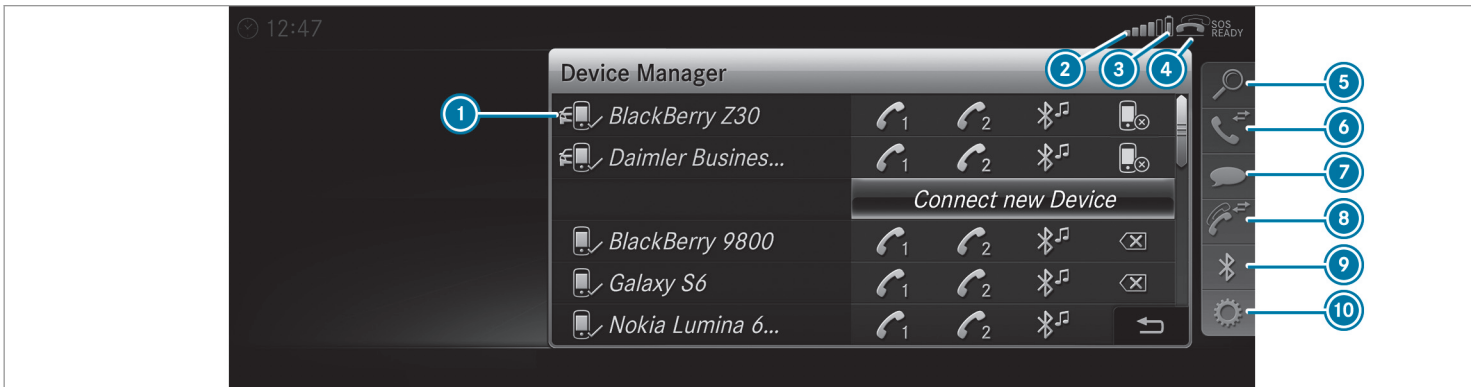
Telephone menu overview



- ① Bluetooth® device name of the currently connected mobile phone
- ② Signal strength of the mobile phone network for the currently connected and selected mobile phone
- ③ Battery status of the currently connected and selected mobile phone

- ④  (telephone ready) or  (call active)
- ⑤ [Contacts](#) (→ page 280)
- ⑥ [Recent Calls](#) (→ page 282)
- ⑦ [Text Message](#)
- ⑧ One mobile phone connected: [Active Call](#).

- Two mobile phones connected: changes view between telephone 1 and 2 or [Active Call](#)
- ⑨ [Devices](#) (→ page 275)
- ⑩ [Options](#)

Symbols ① to ④ are not shown until after a mobile phone has been connected to the multimedia system. The symbols depend on your mobile phone and your mobile phone network provider.

Bluetooth® profile overview

Bluetooth® profile of the mobile phone	Function
PBAP (Phone Book Access Profile)	Contacts are automatically displayed in the multimedia system
MAP (Message Access Profile)	Message functions can be used

Telephony operating modes overview

Depending on your equipment, the following telephony operating modes are available:

- A mobile phone is connected to the multimedia system via Bluetooth® (→ page 275).

- Two mobile phones are connected with the multimedia system via Bluetooth® (two phone mode) (→ page 276).

Information on telephony

The following situations can lead to the call being disconnected while the vehicle is in motion:

- There is insufficient network coverage in the area
- You move from one GSM or UMTS transmitter/receiver area (cell) into another and no communication channels are free
- The SIM card used is not compatible with the network available
- A mobile phone with "Twincard" is logged into the network with the second SIM card at the same time

The multimedia system supports calls in HD Voice® for improved speech quality. A requirement for this is that the mobile phone and the mobile phone network provider of the person you are calling support HD Voice®.

Depending on the quality of the connection, the voice quality may fluctuate.

Connecting a mobile phone (Bluetooth® telephony)

Requirements:

- Bluetooth® is activated on the mobile phone (see the manufacturer's operating instructions).
- Bluetooth® is activated on the multimedia system (→ page 238).

Multimedia system:

☞ Phone ➤ ⌘ Devices

Searching for a mobile phone

▶ Select **Connect New Device**.

▶ Select **Start Search on System**.

The available mobile phones are displayed. If a new mobile phone is found, it is indicated by the  symbol.

Connecting a mobile phone (authorization using Secure Simple Pairing)

- ▶ Select the mobile phone.
A code is displayed in the multimedia system and on the mobile phone.
- ▶ **If the codes match:** confirm the code on the mobile phone.

Connecting a mobile phone (authorization by entering a passkey)

- ▶ Select the mobile phone.
 - ▶ Choose a one to sixteen-digit number combination as a passkey.
 - ▶ **On the multimedia system:** enter the passkey and select .
 - ▶ **On the mobile phone:** enter the passkey again and confirm.
- i** Up to 15 mobile phones can be authorized on the multimedia system. Authorized mobile phones are reconnected automatically.

Connecting a second mobile phone (two phone mode)

Requirements:

- At least one mobile phone is already connected to the multimedia system via Bluetooth®.

Multimedia system:

↳ Phone ▶▶ ⌘ Devices

- ▶ Select **Connect New Device**.
- ▶ Select **Start Search on System**.
The available mobile phones are displayed.
- ▶ Select the mobile phone.
- ▶ Answer the **How would you like to connect the new device?** prompt.
- ▶ **To replace the currently connected mobile phone:** select **Phone 1**.
The currently connected mobile phone is replaced by the new mobile phone.

or

- ▶ **To connect the second mobile phone:** select **Phone 2**.
The new mobile phone is connected as **Phone 2**. If two mobile phones have already

been connected, the second telephone is replaced by the new mobile phone.

or

- ▶ **To use the mobile phone as an audio source:** select **Audio Source** (→ page 310).
- i** A mobile phone can be operated both as an audio source as well as telephone in parallel.
- i** It is possible at any future point to change the type of connection for the mobile phone already connected and to set this as **Phone 1**, **Phone 2** or **Audio Source** (→ page 277).

Functions of the mobile phone in two phone mode

Functions overview

Mobile phone in the foreground	Mobile phone in the background
Full range of functions	Incoming calls

Interchanging mobile phones (two phone mode)

Requirements:

- The mobile phones are authorized (→ page 275).

Multimedia system:

→ Phone ▶ ⌘ Devices

- In the device overview, select a mobile phone which has already been authorized and set as **Phone 1** or **Phone 2**.

After interchanging the mobile phones, the mobile phone in the foreground is replaced by the mobile phone in the background.

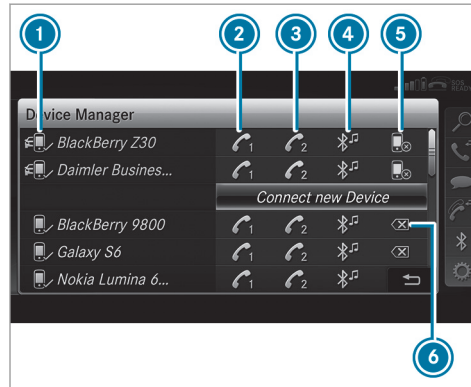

- Bluetooth® device name of the currently connected mobile phone
- Connects a mobile phone as **Phone 1**
- Connects a mobile phone as **Phone 2**
- Connects a mobile phone as **Audio Source**
- Disconnecting a mobile phone(→ page 277)
- De-authorizing a mobile phone(→ page 277)

- If a new mobile phone is connected and defined as **Phone 1**, for example, this overwrites the previously connected mobile phone in the foreground of the system.

Disconnecting a mobile phone

Multimedia system:

→ Phone ▶ ⌘ Devices

- Select the  symbol in the line of the mobile phone.
The disconnection of the mobile phone takes place without a confirmation prompt. The mobile phone remains authorized in the system.

De-authorizing a mobile phone

Multimedia system:

→ Phone ▶ ⌘ Devices

- Select the  symbol in the line of the mobile phone.
- Answer the confirmation prompt with **Yes**.
The mobile phone is deauthorized and deleted from the system.

Information on Near Field Communication (NFC)

NFC enables short-range wireless data transfer or (re)connection of a mobile phone with the multimedia system.

The following functions are available without having authorized a mobile phone:

- Transferring a URL to be viewed in the multimedia system (see the manufacturer's operating instructions).
- Setting up the vehicle's Wi-Fi access data via the system settings (→ page 240).

Further information can be found at: <http://www.mercedes-benz.com/connect>

Using the mobile phone with Near Field Communication (NFC)

Requirements:

- NFC is activated on the mobile phone (see the manufacturer's operating instructions)
- The mobile phone's screen is switched on and unlocked (see the manufacturer's operating instructions)

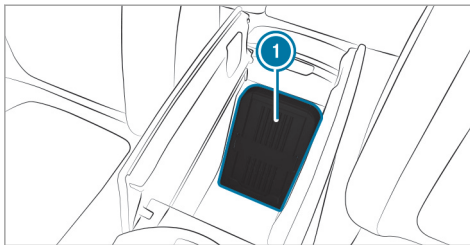

- ▶ **To connect a mobile phone:** hold the NFC area of the mobile phone (see manufacturer's operating instructions) on mat ① or place the mobile phone on it. The mobile phone is connected to the multimedia system.
- ▶ **To change a mobile phone:** hold the NFC area of the mobile phone (see manufacturer's operating instructions) on the mat or place the mobile phone on it. If the mobile phone has already been authorised on the multimedia system, it is now connected. If the mobile phone is authorised on the multimedia system for the first time, it is connec-

ted after confirming the mobile phone instructions (see the manufacturer's operating instructions).

Further information can be found at: <http://www.mercedes-benz.com/connect>

Setting the reception and transmission volume

Requirements:

- A mobile phone is authorized (→ page 275).

Multimedia system:

☛ Phone ▶ ⚙ Options ▶ Phone

This function ensures optimal language quality.

- ▶ Select **Reception Volume** or **Transmission Volume**.
- ▶ Set the volume.

Further information on the recommended reception and transmission volume: <http://www.mercedes-benz.com/connect>

Adjusting the call and ringtone volume

Multimedia system:

→ System ▶▶  Audio ▶▶ Phone

- ▶ Select [Call Volume](#) or [Ringtone Volume](#).
- ▶ Set the volume.

Starting/stopping mobile phone voice recognition

Requirements:

- The mobile phone is connected to the multimedia system (→ page 275).

Starting mobile phone voice recognition

- ▶ Press and hold the  button on the multi-function steering wheel for more than one second.
You can use mobile phone voice recognition.

Stopping mobile phone voice recognition

- ▶ Press the  or  button on the multi-function steering wheel.

Calls

Using the telephone

Multimedia system:

→ Phone ▶▶  Contacts

Making a call

- ▶ Select [Numerical Keypad](#).
- ▶ Enter the number.
- ▶ Select .
- ▶ The call is made.

Accepting a call

- ▶ Select [Accept](#).

Rejecting a call

- ▶ Select [Reject](#).

Ending a call

- ▶ Select .

Activating functions during a call

- ▶ To show all functions, navigate down.

The following functions are available during a call:

- [End Call](#)
- [Make Additional Call](#)
- [Keyboard](#) (show to send DTMF tones)
- Switch [Mute Mic](#) on or off .
- [Private Mode](#) (an active call in hands-free mode is transferred over to the telephone)

Conducting calls with several participants

Requirements:

- There is an active call (→ page 279).
- Another call is being made.

Switching between calls

- ▶ Select call •.
The selected call is active. The other call is on hold.

Activating or ending a call on hold

- ▶ Select [Continue Call](#) or [End Call](#).

Conducting a conference call

- ▶ Select [Create Conference Call](#) in the telephone menu.
The new participant is included in the conference call.

Ending an active call

- ▶ Select .
- ⓘ On some mobile phones, the call on hold is activated as soon as the active call is ended.

Accepting/rejecting a waiting call

Requirements:

- There is an active call (→ page 279).

If you receive a call while already in a call, a message is displayed. An acoustic signal also sounds.

- ▶ Select [Accept](#).
The incoming call is active.
If only one mobile phone is connected with the multimedia system, the previous call will be put on hold.

If during a call you accept a call with the other mobile phone when in two phone mode then the existing call is ended.

- ▶ Select [Reject](#).
- ⓘ This function and behavior depends on your mobile phone network provider and the mobile phone (see the manufacturer's operating instructions).

Contacts

Information about the contacts menu

The contacts menu contains all contacts from existing data sources, e.g. mobile phone or memory card. You can store up to 6,000 contacts.

Depending on the data source, you have the following number of contacts:

- Permanently saved contacts: 3,000 entries
- Contacts loaded from the mobile phone: 3,000 entries

From the contacts menu, you can perform the following actions:

- Using the telephone:
 - Calling a contact (→ page 282)
 - Calling a new number (→ page 279)
- Navigation (→ page 253)
- Compose messages (→ page 283)

If a mobile phone is connected to the multimedia system (→ page 275) and automatic calling up (→ page 280) is activated, the mobile phone's contacts are displayed in the address book.

Downloading mobile phone contacts

Multimedia system:

 [Phone](#) ▶  [Options](#) ▶ [Contacts](#)

Automatically

- ▶ Switch [Synchronize Contacts Automatically](#) on .

Manually

- ▶ Deactivate [Synchronize Contacts Automatically](#).

- ▶ Select **Synchronize Contacts**.

Calling up contacts

Multimedia system:

☞ Phone ▶  Contacts

Depending on the character set, the following options can be used to search for contacts:

- searching by initials
- searching by name
- searching by phone number

- ▶ Enter characters into the search field. A selection of possible contacts appears. Entering more characters into the search field narrows down the number of possible selections.

- ▶ Select the contact.

A contact can contain the following details:

- phone numbers
- navigation addresses
- geo-coordinates
- Internet address

Editing the format of a contact's name

Multimedia system:

☞ Phone ▶  Options ▶ Contacts
▶▶ Name Format



The following options are available:



- **Last Name, First Name**
- **Last Name First Name**
- **First Name Last Name**

- ▶ Select an option.

Overview of importing contacts

Contacts from various sources

Source	Requirements
 Memory card	The SD memory card is inserted.
 USB device	The USB device is inserted in the USB port.

Source	Requirements
 Bluetooth® connection	If the sending of vCards via Bluetooth® is supported, vCards can be received on mobile phones or networks, for example. Bluetooth® is activated in the multimedia system and on the respective device (see the manufacturer's operating instructions).
 Mobile phone	The mobile phone is connected to the multimedia system.

Importing contacts into the contacts menu

Multimedia system:



☞ Phone ▶  Options ▶ Contacts

- ▶ Select **Import**.
- ▶ Select an option.

Saving a mobile phone contact

Multimedia system:

☞ Phone >> 🔍 Contacts

- ▶ Select the mobile phone contact .
- ▶ Select .
- ▶ Select **Save to Vehicle**.
The contact saved in the multimedia system is identified by the  symbol.

Calling a contact

Multimedia system:

☞ Phone >> 🔍 Contacts

- ▶ Enter characters into the search field.
- ▶ Select the contact.
- ▶ Select the telephone number.
The number is dialed.

Selecting further options in the contacts menu

Multimedia system:

☞ Phone >> 🔍 Contacts

- ▶ Select a contact.
- ▶ Select .

Depending on the stored data, the following options are available:

- **Call**
 - **Send Text Message**
 - **Show Website** (if an Internet address has been stored)
 - **Navigate** (if an address has been stored)
 - **Save My Favorite**
 - **Send DTMF Tones** (for a number with DTMF tones)
- ▶ Select an option.

Deleting a contact

Multimedia system:

☞ Phone >> 🔍 Contacts

You can delete contacts stored in the vehicle.

- ▶ Search for the contact.
- ▶ Select the contact.
- ▶ Select .
- ▶ Select **Delete Contact**.
- ▶ Select **Yes**.

Call list

Call list overview

Depending on whether your mobile phone supports the PBAP Bluetooth® profile or not, this can have different effects on the presentation and functions of the call list.

If the PBAP Bluetooth® profile is supported, the effects are as follows:

- The call lists from the mobile phone are displayed in the multimedia system.
- When connecting the mobile phone, you may have to confirm the connection for the PBAP Bluetooth® profile.

If the PBAP Bluetooth® profile is not supported, the effects are as follows:

- The multimedia system generates its own call lists.
- The call list is not synchronized with the call lists in the mobile phone.

Making a call from the call list

Multimedia system:

➤ Phone ➤  Recent Calls

- ▶ Select a number.
The call is made.

Text messages

Overview of text message functions

If the connected mobile phone supports the MAP Bluetooth® profile, the text message functions can be used on the multimedia system.

You can obtain further information about settings and supported functions of Bluetooth®-capable mobile phones from an authorized Mercedes-Benz Center or at: <http://www.mercedes-benz.com/connect>

Some mobile phones require further settings after being connected to the multimedia system (see manufacturer's operating instructions).

New messages are identified by the  symbol in the media display and an audible signal.

Depending on the mobile phone, the multimedia system only displays new incoming text messages or the 100 newest text messages.

Configuring the text messages displayed

Multimedia system:

➤ Phone ➤  Options ➤ Text Message
➤ Message Display

- ▶ Select .

A menu with the following options is shown:

- All Messages
- New and Unread Messages
- New Messages
- Off (The text messages are not displayed automatically.)

- ▶ Select an option.

- ⓘ The setting may not be active until the mobile phone is reconnected.

Reading text messages

Multimedia system:

➤ Phone ➤  Text Message

Reading a text message

- ▶ Select a text message.
The message text is displayed.

Using the read-aloud function

- ▶ Select a text message.
- ▶ Select **Read Aloud**.
The text message is read aloud.

Composing and sending a text message

Multimedia system:

➤ Phone ➤  Text Message

- ▶ Select **Write New Text Message**.

Adding a recipient

- ▶ Select **Press to Add Recipient**.
- ▶ Select the contact.

Dictating text

- ▶ Select **Press to Dictate**.

- ▶ **To start the dictation function:** press on the central control element. The app for the dictation function is loaded. If there was no prior Internet connection, a connection is now established.
- ▶ Say the message. The dictation ends automatically after you have finished speaking. After the voice message has been processed, it is shown as text.
- ▶ **To replace a message:** select [Replace message](#). The text that has been dictated and shown on the display is reset and can be dictated again.

Editing text

- ▶ Select the word.
- ▶ **To call up the correction menu:** press on the central control element. The following options are available:
 - Adjusting the capitalization of words (if supported by the character set)

- Expanding the choice of words
- Deleting the selection
- Recording a new dictation

- ▶ **To leave the menu:** select [Done](#).

Sending text messages

- ▶ Select [Send Text Message](#).

Replying to a text message

Multimedia system:

↳ Phone ▶  [Text Message](#)

- ▶ Open the text message.
- ▶ Select .
- ▶ Select [Reply](#).

Calling a text message sender

Multimedia system:

↳ Phone ▶  [Text Message](#)

- ▶ Open the text message.
- ▶ Select .
- ▶ Select [Call Sender](#).

Deleting text messages

Multimedia system:

↳ Phone ▶  [Text Message](#)

- ▶ Select .
 - ▶ **To delete a text message:** select [Delete](#).
 - ▶ [Outbox](#)
- or
- ▶ Select [Drafts](#).

Mercedes-Benz link

Overview of Mercedes-Benz Link



Using Mercedes-Benz Link, various functions and selected mobile phone apps can be transferred to the media display.

The Mercedes-Benz Link control box supplementary equipment is required for this. You can obtain this at an authorized Mercedes-Benz Center.

- ❗ The Mercedes-Benz Link control box uses the Android operating system.

-  The service provider is responsible for these apps and the services and content connected to it.

Connecting Mercedes-Benz Link with the multimedia system

-  Connect the Mercedes-Benz Link control box with the  USB port of the multimedia connection unit using a suitable connecting cable.

-  A suitable connecting cable is available separately at an authorized Mercedes-Benz Center.

Using Mercedes-Benz Link

Requirements:

- The Mercedes-Benz Link control box is connected with the multimedia system using the  USB port.

Multimedia system:

 [Connect](#)

-  Select [Mercedes-Benz Link](#).

-  Select [MB Link](#).
The mobile phone functions and apps are available and shown on the media display.

You can find more information in the Mercedes-Benz Link control box operating instructions.

Ending Mercedes-Benz Link

Multimedia system:

 [Connect](#)  [Mercedes-Benz Link](#)

-  Select [Disconnect](#).
The connection is ended.
The mobile phone continues to be supplied with electricity.

or

-  Disconnect the connecting cable between the Mercedes-Benz Link control box and the multimedia system.



-  Mercedes-Benz recommends disconnecting the connecting cable only when the vehicle is stationary.

Apple CarPlay™

Overview of Apple CarPlay™

 **WARNING** Risk of distraction from information systems and communications equipment

If you operate information and communication equipment integrated in the vehicle when driving, you will be distracted from the traffic situation. This could also cause you to lose control of the vehicle.

-  Only operate this equipment when the traffic situation permits.
-  If you cannot be sure of this, stop the vehicle whilst paying attention to road and traffic conditions and operate the equipment with the vehicle stationary.

You must observe the legal requirements for the country in which you are currently driving when operating the multimedia system.

iPhone® functions can be used via the multimedia system using Apple CarPlay™. They are operated using the central control element or the

Siri® voice-operated control system. You can activate the voice-operated control system by pressing and holding the  button on the multifunction steering wheel.

When using Apple CarPlay™ via the voice-operated control system, the multimedia system can still be operated via the Voice Control System (→ page 213).

Only one mobile phone at a time can be connected via Apple CarPlay™ to the multimedia system.

The availability of Apple CarPlay™ may vary according to the country.

The service provider is responsible for this application and the services and content connected to it.

Information on Apple CarPlay™

While using Apple CarPlay™ various functions of the multimedia system, e.g. telephony or the media sources Bluetooth® audio and iPod®, are unavailable.

Only one route guidance can be active at a time. If route guidance is active on the multimedia system,

it is closed when route guidance is started on the mobile phone.

Connecting an iPhone® via Apple CarPlay™

Requirements:

- Apple® operating system version iOS 8.3 or above is installed on the iPhone®.
- An Internet connection is required for the full range of functions for Apple CarPlay™.
- The iPhone® is connected to the multimedia system via the USB port  using a suitable cable (→ page 304).

Multimedia system:

 [Connect](#)  [Apple CarPlay](#)

Setting automatic or manual start

A message appears when connected for the first time.

- ▶ **Automatic start:** select [Automatically](#). [Start Automatically](#) is activated .

Apple CarPlay™ will now start immediately after the iPhone® is connected to the multimedia system using a USB cable.

- ▶ **Manual start:** select [Manually](#).

- ▶ Select the iPhone® in the device list.

Accepting/rejecting the data protection regulations

A message with the data protection regulations appears.

- ▶ Select [Accept & Start](#).

or

- ▶ Select [Decline & End](#).

Exiting Apple CarPlay™

- ▶ Press the  button on the multifunction steering wheel, for example.

 If Apple CarPlay™ was not displayed in the foreground before disconnecting, the application starts in the background when reconnected. You can call up Apple CarPlay™ in the main menu.

Calling up Apple CarPlay™ sound settings

Multimedia system:

 [Connect](#)  [Apple CarPlay](#)  [Sound](#)

- ▶ Select the tone menu (→ page 321).

Ending Apple CarPlay™

Multimedia system:

↪ Connect ▶ Apple CarPlay

- ▶ Select **Disconnect**.
The connection is ended.

The mobile phone continues to be supplied with electricity.

or

- ▶ Disconnect the connecting cable between the mobile phone and multimedia system. Mercedes-Benz recommends disconnecting the connecting cable only when the vehicle is stationary.

Android Auto

Android Auto overview

⚠ WARNING Risk of distraction from information systems and communications equipment

If you operate information and communication equipment integrated in the vehicle

when driving, you will be distracted from the traffic situation. This could also cause you to lose control of the vehicle.

- ▶ Only operate this equipment when the traffic situation permits.
- ▶ If you cannot be sure of this, stop the vehicle whilst paying attention to road and traffic conditions and operate the equipment with the vehicle stationary.

You must observe the legal requirements for the country in which you are currently driving when operating the multimedia system. Mobile phone functions can be used with Android Auto using the Android operating system on the multimedia system. It is operated using the central control element or the voice control. You can activate the voice-operated control system by pressing and holding the  button on the multifunction steering wheel.

When using Android Auto via the voice-operated control system, the multimedia system can still be operated via the Voice Control System (→ page 213).

Only one mobile phone at a time can be connected via Android Auto to the multimedia system.

The availability of Android Auto and Android Auto Apps may vary according to the country.

The service provider is responsible for this application and the services and content connected to it.

Information on Android Auto

While using Android Auto, various functions of the multimedia system, for example the media source Bluetooth® audio, are not available.

Only one route guidance can be active at a time. If route guidance is active on the multimedia system, it is closed when route guidance is started on the mobile phone.

Connecting a mobile phone via Android Auto

Requirements:

- The first activation of Android Auto on the multimedia system must be carried out when the vehicle is stationary for safety reasons.
- The mobile phone supports Android Auto from Android 5.0.

- The Android Auto app is installed on the mobile phone.
- In order to use the telephone functions, the mobile phone must be connected to the multimedia system via Bluetooth® (→ page 275). If there was no prior Internet connection, this is established with the use of the mobile phone with Android Auto.
- The mobile phone is connected to the multimedia system via the USB port  using a suitable cable (→ page 304).
- An Internet connection is required for the full range of functions for Android Auto.

Multimedia system:

↪ [Connect](#) ➤ [Android Auto](#)

- ▶ Select the mobile phone from the device list.

Accepting/rejecting the data protection regulations

A message with the data protection regulations appears.

- ▶ Select [Accept & Start](#).

or

- ▶ Select [Decline & End](#).

Activating automatic start

- ▶ Select [Start Automatically](#) .

Starting manually

- ▶ Select the mobile phone from the device list.

Exiting Android Auto

- ▶ Press the  button on the multifunction steering wheel, for example.
- ⓘ If Android Auto was not displayed in the foreground before disconnecting, the application starts in the background when reconnected. You can call up Android Auto in the main menu.

Calling up the Android Auto sound settings

Multimedia system:

↪ [Connect](#) ➤ [Android Auto](#) ➤ [Sound](#)

- ▶ Select the tone menu (→ page 321).

Ending Android Auto

Multimedia system:

↪ [Connect](#) ➤ [Android Auto](#)

- ▶ Select [Disconnect](#).
The connection is ended.
The mobile phone continues to be supplied with electricity.

or

- ▶ Disconnect the connecting cable between the mobile phone and multimedia system. Mercedes-Benz recommends disconnecting the connecting cable only when the vehicle is stationary.

Transferred vehicle data with Android Auto and Apple CarPlay™

Overview of transferred vehicle data

When using Android Auto or Apple CarPlay™, certain vehicle data is transferred to the mobile phone. This enables you to get the best out of selected mobile phone services. Vehicle data is not directly accessible.

The following system information is transmitted:

- Software release of the multimedia system
- System ID (anonymized)

The transfer of this data is used to optimize communication between the vehicle and the mobile phone.

To do this, and to assign several vehicles to the mobile phone, a vehicle identifier is randomly generated.

This has no connection to the vehicle identification number (VIN) and is deleted when the multimedia system is reset (→ page 247).

The following driving status data is transmitted:

- Transmission position engaged
- Distinction between parking, standstill, rolling and driving
- Day/night mode of the instrument cluster

The transfer of this data is used to alter how content is displayed to correspond to the driving situation.

The following position data is transmitted:

- Coordinates
- Speed
- Compass direction
- Acceleration direction

This data is only transferred while the navigation system is active in order to improve it (e.g. so it can continue functioning when in a tunnel).

Mercedes me connect

Notes on Mercedes me connect

Mercedes me connect provides the following services:

- Accident and breakdown management (me button)
- Concierge Service (when the service is activated), appointment requests or similar (me button)
- Mercedes-Benz emergency call system (automatic emergency call or SOS button)

The Mercedes-Benz Customer Center and the Mercedes-Benz emergency call center are available for you around the clock.

The me button and the SOS button can be found on the vehicle's overhead control panel (→ page 290).

You can also call the Mercedes-Benz Customer Center using the multimedia system (→ page 290).

Please note that Mercedes me connect is a Mercedes-Benz service. In emergencies, always call the national emergency services first using the standard national emergency service phone numbers. In emergencies, you can also use the Mercedes-Benz emergency call system (→ page 292).

Observe the conditions of use for Mercedes me connect and other services. These can be obtained in the Mercedes me portal: <https://me.secure.mercedes-benz.com>

Calling the Mercedes-Benz Customer Center using the multimedia system

Requirements:

- You have access to a GSM network.
- The contract partner's GSM network coverage is available in the respective region.
- The ignition is switched on so that vehicle data can be transferred automatically.

Multimedia system:

➔ Phone ➔ 🔍 Contacts

- ▶ Call [Mercedes me connect](#). The call is made.

Then, you can select a service and be connected to a specialist at the Mercedes-Benz Customer Center.

Making a call via the overhead control panel

Requirements:

- You have access to a GSM network.
- The contract partner's GSM network coverage is available in the respective region.

- The ignition is switched on so that vehicle data can be transferred automatically.

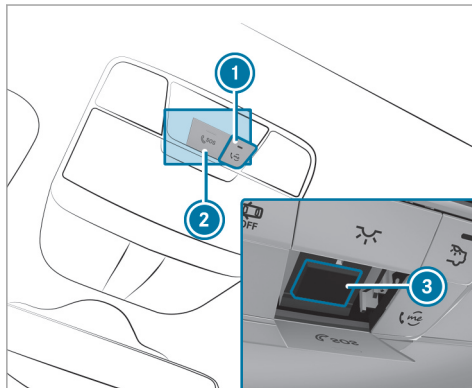

- ① Service call button (me button)
- ② SOS button cover
- ③ SOS button

- ▶ **To make a service call:** press button ①.

- ▶ **To make an emergency call:** press SOS button cover ② briefly to open.

- ▶ Press and hold SOS button ③ for at least one second.

If a service call is active, an emergency call can still be triggered. This has priority over all other active calls.

Service calls are only possible if a mobile phone network is available.

Information about the service call using the me button

A call to the Mercedes-Benz Customer Center has been initiated via the me button in the overhead control panel or the multimedia system.

In the event of a breakdown, you will get support:

- A qualified Mercedes-Benz technician provides breakdown assistance on site and/or the vehicle will be towed to the nearest authorized Mercedes-Benz Center.

You may be charged for these services.

You can find information on the following topics:

- Activation of Mercedes me connect
- Operating the vehicle
- Nearest authorized Mercedes-Benz Center
- Other products and services from Mercedes-Benz

Data is transferred during the connection to the Mercedes-Benz Customer Center (→ page 291).

Information on Mercedes me connect accident management

The Mercedes me connect accident management is an extension of the Mercedes-Benz emergency call system (→ page 292).

An emergency call is made to the Mercedes-Benz emergency call center after an accident:

- A voice connection is made to a contact person at the Mercedes-Benz emergency call center.
- If necessary, the contact person at the Mercedes-Benz emergency call center forwards the call to Mercedes me connect accident management.

Forwarding the call is not possible in all countries.

- If necessary, the vehicle will be towed to an authorized Mercedes-Benz Center.

Arranging a service appointment via Mercedes me connect

If you have activated the maintenance management service, relevant vehicle data is transferred automatically to the Mercedes-Benz Customer Center. You will then receive individual recommendations regarding the maintenance of your vehicle.

Regardless of whether you have consented to the maintenance management service, the multimedia system reminds you after a certain amount of time that a service is due. A prompt appears asking if you would like to make an appointment.

▶ To arrange a service appointment: select Call.

After your agreement the vehicle data is sent and a Mercedes-Benz Customer Center employee deals with your appointment. The

information is then sent to your desired service outlet.

This service outlet will then contact you within 24 hours.

- ⓘ If you select **Later** after the service message appears, the message is hidden and reappears after a certain period of time.

Transferred data during a service call

Observe the conditions of use for Mercedes me connect and other services. These can be obtained in the Mercedes me portal: <https://me.secure.mercedes-benz.com>

When you make a service call via Mercedes me connect, data will be transmitted.

The following data is transmitted if a service call is made via Mercedes me connect:

- Vehicle identification number
- Reason for the initiation of the call

Mercedes-Benz emergency call system

Information on the Mercedes-Benz emergency call system

Your vehicle is equipped with the Mercedes-Benz emergency call system ("eCall"). This feature can help save lives in the event of an accident. eCall in no way replaces assistance provided from dialing 911.

The Mercedes-Benz emergency call system is available for at least ten years starting from the manufacturing date.



Mercedes-Benz eCall only functions in areas where mobile phone coverage is available from the wireless service providers. Insufficient network coverage from the wireless service providers may result in an emergency call not being transmitted.

eCall is a standard feature in your Mercedes-Benz vehicle. In order to function as intended, the system relies on the transmission of data detailed in the "Mercedes-Benz emergency call system data transmission" section that follows (→ page 294).

To disable eCall, a customer must visit an authorized Mercedes-Benz Service department to deactivate the vehicle's communication module.

Deactivation of this module prevents the activation of any and all Mercedes me connect services. After the deactivation of eCall, automatic emergency call and manual emergency call will not be available.

The ignition must be switched on before an automatic emergency call can be made.

-  eCall is activated at the factory.
-  eCall can be deactivated by an authorized Mercedes-Benz dealer. Please note that in the event ownership of the vehicle is transferred to another owner in its deactivated state, eCall will remain deactivated unless the new owner visits an authorized Mercedes-Benz dealership to reactivate the system.

Overview of the Mercedes-Benz emergency call system

eCall can help to reduce the time between an accident and the arrival of emergency services

at the site of the accident. It helps locate an accident site in places that are difficult to access. However, even if a vehicle is equipped with eCall, this does not mean the system is ON. As such, eCall does not replace dialing 911 in the event of an accident.

The emergency call can be made automatically (→ page 293) or manually (→ page 293). Only make emergency calls if you or others are in need of rescue.

Only make emergency calls if you or others are in need of rescue. Do not make an emergency call in the event of a breakdown or a similar situation.

Displays in the media display:

SOS READY: eCall available

SOS NOT READY: the ignition is not on or eCall is not available.

During an active emergency call,  appears in the display.

You can find more information on the regional availability of eCall system at: http://www.mercedes-benz.com/connect_ecall.

-  If there is a malfunction in the emergency call system (e.g. a malfunction with the speaker, microphone, airbag, SOS button), a corresponding message appears in the multifunction display of the instrument cluster.

Triggering an automatic emergency call

Requirements

- The ignition is switched on.
- The starter battery is sufficiently charged.

If restraint systems such as airbags or Emergency Tensioning Devices have been activated after an accident, the Mercedes-Benz emergency call system may automatically initiate an emergency call.

The emergency call has been made:

- A voice connection is made to the Mercedes-Benz emergency call center.
- A message with accident data is transmitted to the Mercedes-Benz emergency call center.

The Mercedes-Benz emergency call center can transmit the vehicle position data to one of the emergency call centers.

The SOS button in the overhead control panel flashes until the emergency call is finished.

It is not possible to immediately end an automatic emergency call.

If no connection can be made to the emergency services either, a corresponding message appears in the media display.

-  Dial the local emergency number on your mobile phone.

If an emergency call has been initiated:

- Remain in the vehicle if the road and traffic conditions permit you to do so until a voice connection is established with the emergency call center operator.
- Based on the call, the operator decides whether it is necessary to call rescue teams and/or the police to the accident site.
- If no vehicle occupant answers, an ambulance is sent to the vehicle immediately.

Triggering a manual emergency call

-  Press and hold the SOS button in the overhead control panel for at least one second.

The emergency call has been made:

- A voice connection is made to the Mercedes-Benz emergency call center.
- A message with accident data is transmitted to the Mercedes-Benz emergency call center. The Mercedes-Benz emergency call center can transmit the vehicle position data to one of the emergency call centers.
- Remain in the vehicle if the road and traffic conditions permit you to do so until a voice connection is established with the emergency call center service provider.
- On the basis of the call, the service provider decides whether it is necessary to call rescue teams and/or the police to the accident site.

If no connection can be made to the emergency services either, a corresponding message appears in the media display.

-  Dial the local emergency number on your mobile phone.

Ending an unintentional emergency call

▶ **Select**  on the multifunction steering wheel. Depress button for several seconds.

Data transfer of the Mercedes-Benz emergency call system

In the event of an automatic or manual emergency call the following data is transmitted, for example:

- Vehicle's GPS position data
- GPS position data on the route (a few 300 feet (hundred meters) before the incident)
- Direction of travel
- Vehicle identification number
- Vehicle drive type
- Number of people determined to be in the vehicle
- Whether Mercedes me connect is available or not
- Whether the emergency call was initiated manually or automatically
- Time of the accident

- Language setting on the multimedia system

Data transmitted is vehicle information. For any questions about the collection, use and sharing of the eCall system data, please contact MBUSA's Customer Assistance Center at 800-FOR-MERC.

For Canada, please contact MBC's Customer Assistance Center at 1-800-387-000.

Customer requests for covered information should be submitted via the same channels.

For accident clarification purposes, the following measures can be taken up to an hour after the emergency call has been initiated:

- The current vehicle position can be called up
- A voice connection to the vehicle occupants can be established

Online and Internet functions

Internet connection

Information on connecting to the Internet

⚠ WARNING Risk of distraction from information systems and communications equipment

If you operate information and communication equipment integrated in the vehicle when driving, you will be distracted from the traffic situation. This could also cause you to lose control of the vehicle.

- ▶ Only operate this equipment when the traffic situation permits.
- ▶ If you cannot be sure of this, stop the vehicle whilst paying attention to road and traffic conditions and operate the equipment with the vehicle stationary.

You must observe the legal requirements for the country in which you are currently driving when operating the multimedia system.

⚠ WARNING Risk of distraction from operating mobile communication equipment while the vehicle is in motion

If you operate mobile communication equipment when driving, you will be distracted from the traffic situation. This could also cause you to lose control of the vehicle.

▶ Only operate this equipment when the vehicle is stationary.

You must observe the legal requirements for the country in which you are currently driving when operating mobile communication equipment in the vehicle.

The Internet functions can only be used to a limited degree whilst driving.

Function of the communication module

On vehicles with a built-in communication module, the Internet connection is established via an integrated SIM card.

To use Internet access via the communication module the following conditions must be met:

- The vehicle is equipped with a permanently installed communication module.
- Mercedes me connect is active and ready for operation.
- Mercedes me connect is activated for Internet access.
- Country dependent: data volume via Mercedes me connect is available.

If the data volume limit is reached, the availability of Mercedes me connect services is limited. The data volume must be purchased via Mercedes me connect.

i Contact an authorized Mercedes-Benz Center to find out whether it is possible to purchase data volume in your country.

Establishing an Internet connection

Multimedia system:

➔ **Connect**

▶ For example, select  **Browser**.

- i** The multimedia system usually establishes the Internet connection automatically. If the multimedia system is not connected to the Internet, the Internet connection is established when an Internet application is used.
- i** The availability of web browsers is country-dependent.

Connection status

Connection status overview



- 1** Display of existing connection

Displaying the connection status

Multimedia system:

↳ System ▶  Connectivity

▶ Select **Internet Status**.

 In the case of a connection via the communication module the following status information is shown:

- Type of network
- Status online/offline

Mercedes-Benz Apps

Calling up Mercedes-Benz Apps

Requirements:

- The registration for the use of Mercedes-Benz Apps has been completed.
- The general terms and conditions have been confirmed.

Multimedia system:

↳ Connect ▶  Mercedes-Benz Apps

▶ Select an app.

-  The available features are country-dependent. License fees may be applicable.

Operating Mercedes-Benz Apps using voice control

Requirements:

- The registration for the use of Mercedes-Benz Apps has been completed.
- The general terms and conditions have been confirmed.

The  symbol indicates that a Mercedes-Benz app can be used via voice control.

▶ Select a Mercedes-Benz app. The app menu is displayed.

▶ **To use voice control:** select  Language.

▶ Say the question or command.

-  Voice control is not available in all countries and languages.

Web browser

Calling up a web page

 **WARNING** Risk of distraction from information systems and communications equipment

If you operate information and communication equipment integrated in the vehicle when driving, you will be distracted from the traffic situation. This could also cause you to lose control of the vehicle.

- ▶ Only operate this equipment when the traffic situation permits.
- ▶ If you cannot be sure of this, stop the vehicle whilst paying attention to road and traffic conditions and operate the equipment with the vehicle stationary.

You must observe the legal requirements for the country in which you are currently driving when operating the multimedia system.

Multimedia system:

➔ Connect ➔  Browser
➔  Enter URL

▶ Enter a web address.

ⓘ The function is country-dependent.

▶ **To finish the entry and call up the website:** select .

Showing/hiding the web browser menu

If you call up a website by selecting a link, for example, the web browser menu is hidden.

▶ **To show/hide:** press the button.

ⓘ The web browser supports video playback.

ⓘ No websites or videos are displayed while the vehicle is in motion.

Web browser overview



- ① URL entry
- ② Bookmarks
- ③ Web page, back
- ④ Web page, forwards
- ⑤ Options
- ⑥ Closes the browser

Calling up web browser options

Multimedia system:

➔ Connect ➔  Browser
➔  Options

The following functions are available:

- Refresh Page/Cancel
- Zoom
- Browser Settings
- Delete Browser Data

▶ Select an option.

▶ Make the desired changes to the settings.

Calling up the web browser settings

Multimedia system:

➔ Connect ➔  Browser
➔  Options ➔ Browser Settings

The following functions are available:

- Block Pop-Ups
- Activate Javascript
- Allow Cookies

▶ Activate or deactivate the function.

Deleting browser data

Multimedia system:

- Connect ➤  Browser
-  Options ➤ Delete Browser Data

The following options are available:

- All
- Cache
- Cookies
- Entered URLs
- Form Data

- ▶ Select an option.
- ▶ Select **Yes**.

Managing bookmarks

Multimedia system:

- Connect ➤  Browser
-  Bookmarks

Selecting a bookmark

- ▶ Select an entry.

Creating a bookmark

- ▶ Select **Add New Bookmark**.
- ▶ Enter a URL and a name.
- ▶ Select **ok**.

Editing a bookmark

- ▶ Highlight a bookmark.
- ▶ Select .
- ▶ Select **Edit**.
- ▶ Enter a URL and a name.
- ▶ Select **ok**.

Deleting a bookmark

- ▶ Highlight a bookmark.
- ▶ Select .
- ▶ Select **Delete**.
- ▶ Select **Yes**.

Closing the browser

Multimedia system:

- Connect ➤  Browser
- ▶ Select  **Close Browser**.

Internet radio

Calling up Internet radio

Requirements:

- The Internet radio service is activated.
- The data volume is available.
Depending on the country, data volume may need to be purchased.
- A fast Internet connection for data transmission free of interference.
The services are country-dependent.
For more information, consult an authorized Mercedes-Benz Center.

Multimedia system:

- Radio ➤  Radio Source
- ▶ Select **TuneIn Radio**.
The Internet radio display appears. The last station set starts playing.

- ⓘ The connection quality depends on the local mobile phone reception.

Internet radio overview

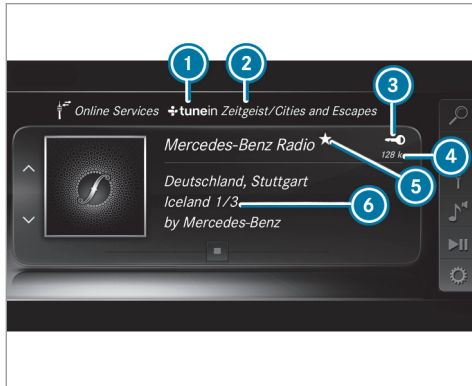

- 1 Internet radio provider
- 2 Selected category
- 3 Display (if connected to private user account)
- 4 Data transfer rate
- 5 Current station is stored as a favorite
- 6 Additional information on the current station

Selecting and connecting Internet radio stations

Multimedia system:

- Radio ➤ Radio Source
- Tuneln Radio ➤ Search

- ▶ Select a category.
- ▶ Select a station.
- ▶ The connection is established automatically.

or

- ▶ Select **Enter Address or POI**.
- ▶ Enter a station name using the entry field.

- ⓘ A relatively large volume of data can be transmitted when using Internet radio.

Saving/deleting an Internet radio station as a favorite

Multimedia system:

- Radio ➤ Radio Source
- Tuneln Radio

- ▶ Select a station.

- ▶ Press and hold the central control element until an audible signal sounds. The symbol appears by the station name.
- ▶ Select **Favorites**. The list of saved favorite stations appears.

or

- ▶ Create an account for the online provider (Tuneln radio) and then log in on the multimedia system. Your favorites are imported to the multimedia system.

Deleting favorites

- ▶ Select **Favorites**.
- ▶ Select a station.
- ▶ Press and hold the central control element until an audible signal sounds. The symbol by the station name disappears.

Setting Internet radio options

Multimedia system:

 Radio
  Radio Source
 TuneIn Radio
  Options

The following options are available:

- **Select Stream:** select the stream quality.
- **Login to TuneIn Account:** log in to your TuneIn user account.
- **Log Out of Account:** log out of your TuneIn user account.

 Select an option.

Media

Audio mode

Information on the audio mode

 **WARNING** Risk of distraction when handling data storage media

If you handle a data storage medium while driving, your attention is diverted from the

traffic conditions. This could also cause you to lose control of the vehicle.

 Only handle a data storage medium when the vehicle is stationary.

Permissible file systems:

- FAT32
- exFAT
- NTFS

Permissible data storage medium:

- SD card
- USB storage device
- iPod®/iPhone®
- MTP devices
- Bluetooth® audio equipment

 Observe the following notes:

- The multimedia system supports a total of up to 50,000 files.
- Data storage media up to 2 TB are supported (32-bit address space).

Supported formats:

- MP3
- WMA
- AAC
- WAV
- FLAC
- ALAC

 Observe the following notes:

- Due to the large variety of available music files regarding encoders, sampling rates and data rates, playback cannot always be guaranteed.
- Due to the wide range of USB devices available on the market, playback cannot be guaranteed for all USB devices.
- Copy-protected music files or DRM encrypted files cannot be played back.
- MP3 players must support Media Transfer Protocol (MTP).



Manufactured under license from Dolby Laboratories. Dolby, Dolby Audio and the double-D symbol are trademarks of Dolby Laboratories.



Gracenote, the Gracenote logo and logotype, "Powered by Gracenote", MusicID and Playlist Plus are either registered trademarks or trademarks of Gracenote, Inc. in the United States and/or other countries.

Notes on copyright

Audio files that you create or reproduce yourself for playback are generally subject to copyright protection. In many countries, reproductions, even for private use, are not permitted without the prior consent of the copyright holder. Make sure that you know about the applicable copyright regulations and that you comply with these.

Activating media mode

Multimedia system:

➔ Media ➔  Media Sources

- ▶ Select a media source.
- ▶ Playable music files are played back.

Inserting/removing an SD card

⚠ DANGER Risk of fatal injury from swallowing SD cards

SD cards are small parts.

They could be swallowed and lead to choking.

- ▶ Keep SD cards out of the reach of children.
- ▶ Seek medical attention immediately if an SD card has been swallowed.

! NOTE Damage due to high temperatures

High temperatures may damage the SD card.

- ▶ Remove the SD card after use and take it out of the vehicle.

Multimedia system:

↳ Media ▶▶  Media Sources
▶▶ Mem. Card

Inserting

The multimedia connection unit is located in the stowage compartment under the armrest.

- ▶ Insert the SD memory card into the SD card slot until it engages. The side with the contacts must face downwards.
Playable music files are played back.

Removing

- ▶ Press the SD card.
- ▶ Remove the SD card.

Overview of the audio mode

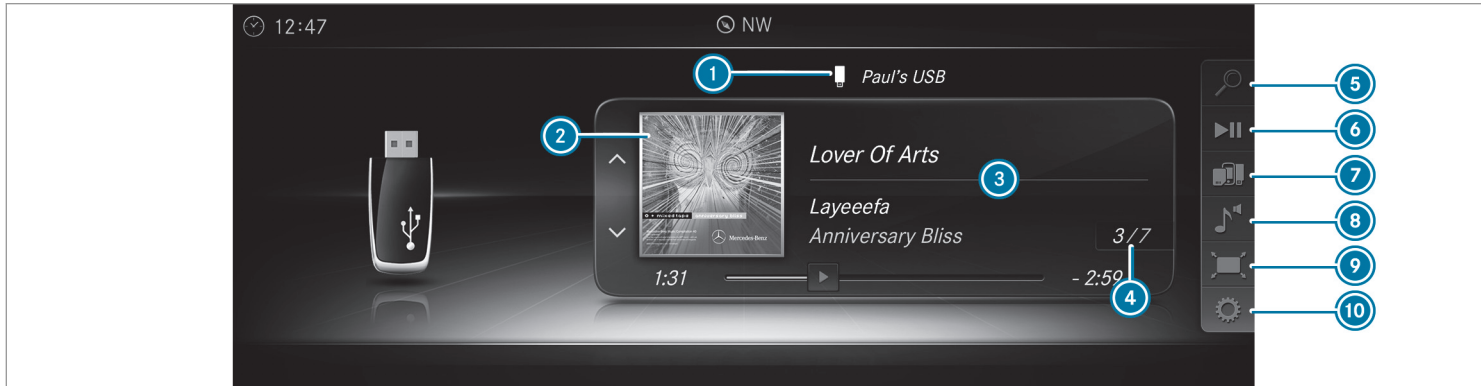

① Active data storage medium

② Album cover

③ Track, artist, album

④ Track number and number of tracks in the track list

⑤ Search

⑥ Playback Control

⑦ Media Sources

⑧ Sound

⑨ Full Screen (for video playback)

⑩ Options

Connecting USB devices

NOTE Damage caused by high temperatures

High temperatures can damage USB devices.

- ▶ Remove the USB device after use and take it out of the vehicle.

The multimedia connection unit is found in the stowage compartment under the armrest and has two USB ports.

Depending on the vehicle's equipment, additional USB ports can be found in the stowage compartment of the center console and in the rear passenger compartment.

- ▶ Connect the USB device to the USB port. Playable music files are played back only if the corresponding media display is activated.
- ① Use the USB port identified by  to use Apple CarPlay™ and Android Auto.
- ① Depending on the vehicle equipment there is an additional USB port in the rear passenger compartment. Ports that are labeled with a

battery symbol can only be used to charge USB devices.

Selecting a track in the media playback

Multimedia system:

 Media

Selecting a track by skipping to a track

- ▶ **To skip backwards or forwards to a track:** navigate up or down.

Selecting a track using the current track list

- ▶ Select .
- ▶ Select **Current Track List**.
- ▶ Select a track.

Selecting playback options

Multimedia system:

 Media  Options

Playing back similar tracks

- ▶ Select **Play Similar Tracks**.
A track list with similar tracks is created and played back.

Playback mode





- ▶ Select **Random Mode - Current Playlist**.
The current track list is played in random order.
- ▶ Select **Random Mode - Current Medium**.
All tracks on the active data storage medium are played in random order.
- ▶ Select **Normal Track Sequence**.
The current track list is played in the order it appears on the data storage medium.

Controlling media playback

Multimedia system:

 Media  Playback Control

A bar with playback controls is shown.

- ▶ **To pause playback:** select and confirm  with the central control element. The  symbol is displayed.
- ▶ **To resume playback:** select and confirm  again with the central control element. The  symbol is displayed.

To fast forward/rewind

- ▶ Move  on the timeline.

To hide the playback controls

- ▶ Press the  button.

Video mode

Switching to video mode

Multimedia system:

 Media   Media Sources

- ▶ Select a data storage medium.
- ▶ Search for and select video files or playlists with video files.
Playable video files are played back.

The multimedia system supports the following formats:

- MPEG
 - AVI, DivX, MKV
 - MP4, M4V
 - WMV
-  If the vehicle is traveling faster than 3 mph (5 km/h) the video image is hidden from the driver. If available, the channel and program information is continuously displayed. Due to the large variety of available video files regarding encoders, sampling rates and data transfer rates, playback cannot be guaranteed.

Videos up to FullHD (1920x1080) are supported. Copy-protected video files or DRM (Digital Rights Management) encrypted files cannot be played back.

Overview of video mode

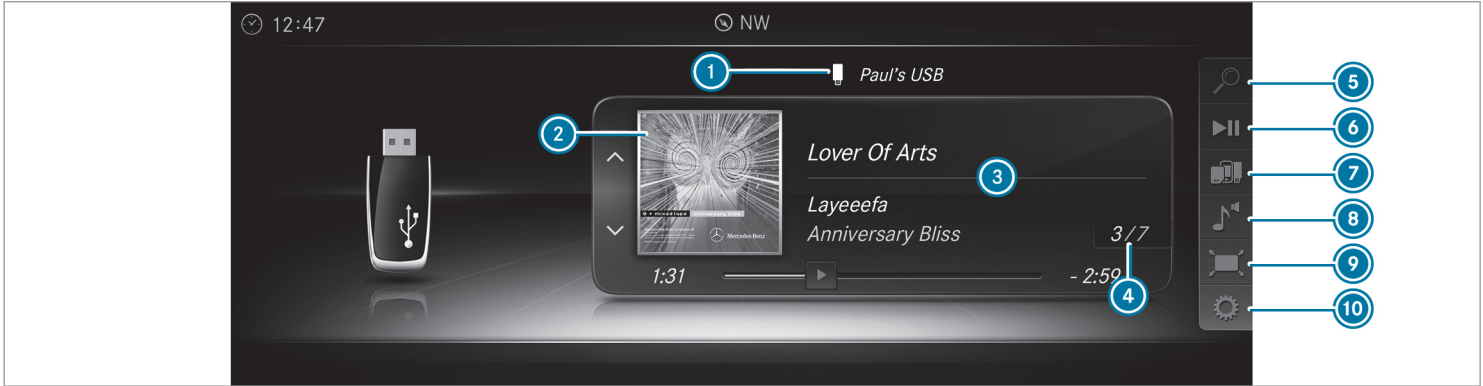

① Active data storage medium

② Album cover

③ Track, artist, album

④ Track number and number of tracks in the track list

⑤ Search

⑥ Playback Control

⑦ Media Sources

⑧ Sound

⑨ Full Screen (for video playback)

⑩ Options

Activating/deactivating full-screen mode

Multimedia system:

↳ Media ▶▶  Media Sources

- ▶ Select a data storage medium.
Playable video files are played back.

- ▶ **To activate full-screen mode:** select  Full Screen.

- ▶ **To deactivate full-screen mode:** press the touchpad.

Changing video settings

Multimedia system:

↳ Media ▶▶  Options

▶▶ Picture Format

The following picture formats are available:

- Automatic
 - 16:9
 - 4:3
 - Zoom
- ▶ Select a picture format.

Adjusting the brightness manually

If the **Automatic** picture format is switched off, you can adjust the brightness yourself.

- ▶ Select **Brightness**.
- ▶ Adjust the brightness.

Media search

Starting the media search

Multimedia system:

↳ Media ▶▶  Search

Depending on the connected media sources and files, the following categories are listed:

- **Current Track List**
- **Keyword Search**
- **Playlists**
- **Artists**
- **Albums**
- **Tracks**
- **Folders**
- **Music Genres**
- **Year**

- **Composers**
- **Videos**
- **Podcasts** (Apple® devices)
- **Audiobooks** (Apple® devices)

- ▶ Select a category.

- ⓘ The categories are available as soon as the entire media content has been read in and analyzed.

Media Interface

Information about the Media Interface

Media Interface is a universal interface for the connection of mobile audio equipment. The multimedia system has two USB ports. The USB ports are located in the stowage compartment under the armrest.

Supported devices

The Media Interface allows you to connect the following data storage media:

- iPod®
- iPhone®

- MP3 player
- USB devices

For details and a list of supported devices, visit our website at <http://www.mercedes-benz.com/connect>. Follow the instructions in the "Media Interface" section.

Switching to Media Interface

Multimedia system:

 [Media](#)   [Media Sources](#)

- ▶ Connect a data storage medium to the USB port (→ page 304).

- ▶ Select a media device.
▶ Playable music files are played back.

Overview of Media Interface

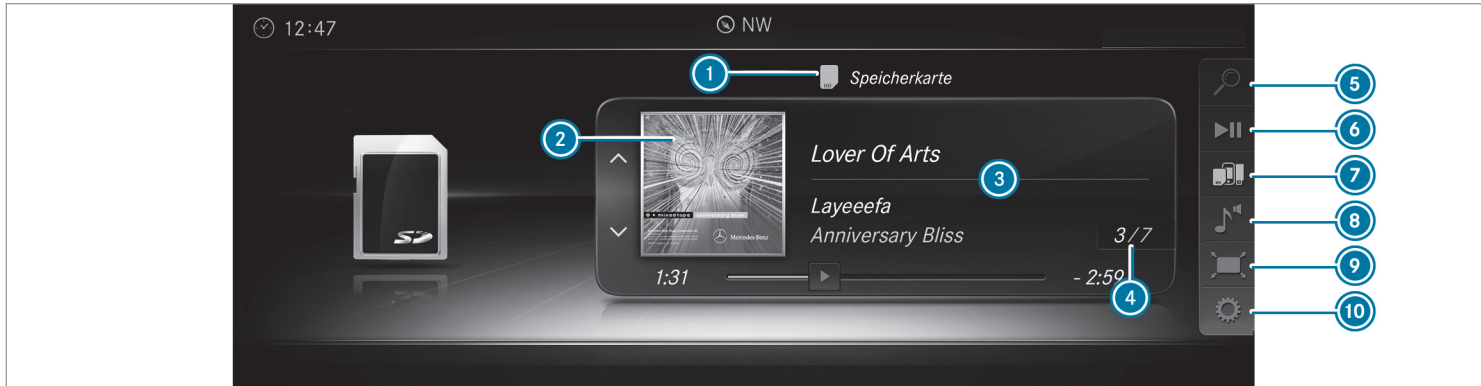

① Active data storage medium

② Album cover

③ Artist, track and album

④ Track number and number of tracks in the track list

⑤ Search

⑥ Playback Control

⑦ Media Sources

⑧ Sound

⑨ Full Screen (video playback only)

⑩ Options

Bluetooth® audio

Information about Bluetooth® audio

Before using your Bluetooth® audio equipment with the multimedia system for the first time, you will need to authorize it (→ page 311).

Bluetooth® audio overview

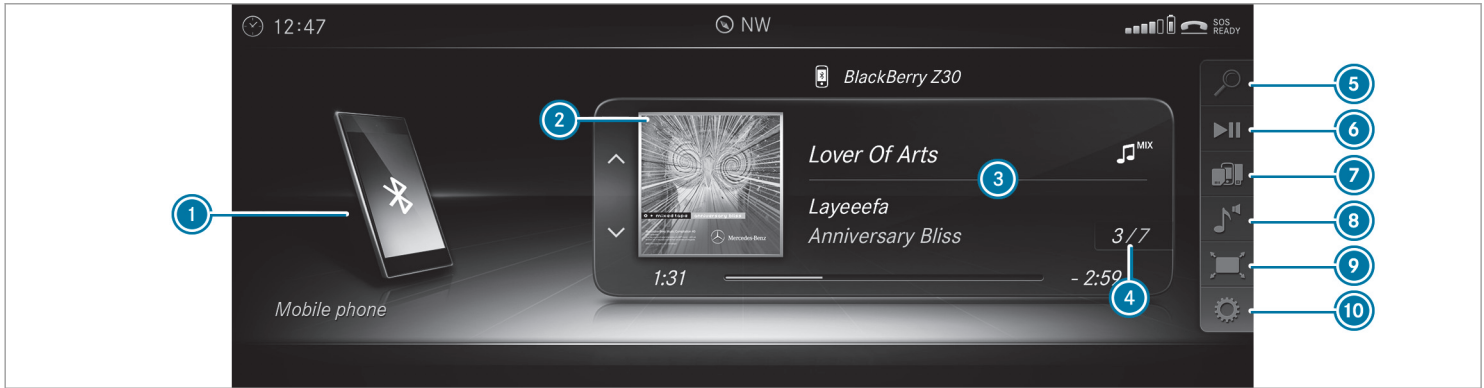

- 1 Active data storage medium
- 2 Album cover

- 3 Track, artist, album

- 4 Track number and number of tracks in the track list

- 5 Search
- 6 Playback Control

Searching for and authorizing a Bluetooth® audio device

Requirements:

- Bluetooth® is activated on the multimedia system and audio equipment (→ page 238).
- The audio equipment supports the Bluetooth® audio profiles A2DP and AVRCP.
- The audio equipment is "visible" for other devices.

Multimedia system:

- Media ➤  Media Sources
-  Bluetooth Audio

Authorizing a new Bluetooth® audio device

- ▶ Select .
- ▶ Select **Add New Bluetooth Audio Device**.
- ▶ Select **Start Search on System**.
Detected audio equipment is displayed in the device list.

- 7 Media Sources
- 8 Sound

- ▶ Select a Bluetooth® audio device. Authorization starts. A code is displayed on the multimedia system and on the mobile phone.
- ▶ If the codes are identical, confirm on the audio equipment.
The audio equipment is connected and playback starts.

Selecting previously authorized Bluetooth® audio equipment

- ▶ Select .
- ▶ Select a Bluetooth® audio device.

Establishing a connection from the Bluetooth® audio equipment

The Bluetooth® device name of the multimedia system is **MB BLUETOOTH XXXXX**.

- ▶ Select **Search from Device**.

- 9 Full Screen (video playback only)
- 10 Options

- ▶ Start the authorization on the audio equipment (see manufacturer's operating instructions).
A code is displayed on the multimedia system and on the audio device.
- ▶ Confirm on both devices if the codes are identical.
The audio equipment is connected and playback starts.

With some audio equipment, playback must be initially started on the device itself so that the multimedia system can play the audio files.

- ⓘ Device-specific information on authorizing and connecting Bluetooth®-capable mobile phones can be obtained at <http://www.mercedes-benz.com/connect> or from an authorized Mercedes-Benz Center.

Activating Bluetooth® audio

Multimedia system:

↳ Media ▶  Media Sources

- ▶ Select  **Bluetooth Audio**.
The multimedia system activates the connected Bluetooth® audio equipment.

Selecting the media player on the Bluetooth® audio device

Multimedia system:

↳ Media ▶ 

- ▶ Select the **Bluetooth Audio Players** category.
If multiple media players are present on the Bluetooth® audio equipment a list appears.
 - ▶ Select a media player.
Playback starts.
- i** The function is not supported by every mobile phone.

Searching for a music track on the Bluetooth® audio device

Multimedia system:

↳ Media ▶  Media Sources

▶  **Bluetooth Audio**

- ▶ Select .
 - ▶ Select a category.
A track list appears.
 - ▶ Select a track.
- i** The function is only available when the mobile phone and the media player selected on the mobile phone support this function.

Switching Bluetooth® audio equipment via NFC**Requirements:**

- Observe the notes on using NFC (→ page 278).
- The Bluetooth® audio overview is displayed (→ page 310).

- ▶ Lightly press the NFC area on the mobile phone (see the manufacturer's operating instructions).

If the mobile phone has already been authorized on the multimedia system as Bluetooth® audio equipment, it is now connected.

If the mobile phone is authorized on the multimedia system as Bluetooth® audio equipment for the first time, it is connected after confirming the instructions for the mobile phone (see the manufacturer's operating instructions).

Disconnecting Bluetooth® audio equipment

Multimedia system:

↳ Phone ▶  Media Sources

- ▶ Select the  symbol in the line of the mobile phone.
The disconnection of the mobile phone takes place without a confirmation prompt. The mobile phone remains authorized in the system.

Starting cinema mode

Multimedia system:

- ↳ Media
- ↳  Media Sources
- ↳ Loudspeaker Audio Source

In cinema mode, a media source connected to the Rear Seat Entertainment System is simultaneously played in the multimedia system.

- ▶ Select the Rear Seat Entertainment System device.
The media source is also played on the multimedia system.

Radio

Switching on the radio

Multimedia system:

- ↳ Radio

- ▶ Alternatively: press the  button.
The radio display appears. You will hear the last station played on the last frequency band selected.

Radio overview



- ① Active frequency band
- ② Station name or set frequency
- ③ Artist, title, album and radio text

- ④ Station list
- ⑤ Presets
- ⑥ Radio Source

- ⑦ Sound
- ⑧ Options

Switching the HD Radio function on/off

Multimedia system:

↳ Radio ▶▶  Options ▶▶ HD Radio



▶ Switch the function on or off .

① HD Radio Technology manufactured under license from iBiquity Digital Corporation. U.S. and Foreign Patents. HD Radio™ and the HD, HD Radio and "Arc" logos are proprietary trademarks of iBiquity Digital Corp.

Setting the waveband

Multimedia system:

↳ Radio ▶▶  Radio Source

HD Radio FM HD Radio AM and SiriusXM Radio can be selected.

▶ Select a frequency band.

Selecting a radio station

Multimedia system:

↳ Radio

▶ Navigate up or down.

Calling up the radio station list

Multimedia system:

↳ Radio ▶▶ 

▶ Select a station.

Searching for radio stations using station names or direct frequency entry

Multimedia system:

↳ Radio ▶▶  ▶▶ 

- ▶ Enter a station name or frequency.
- ▶ Select .
- ▶ The search results are displayed.
- ▶ Select a station.

Storing radio stations

Multimedia system:

↳ Radio ▶▶  Presets

▶ Select Store Current Station in the Presets.

Editing radio station presets

Multimedia system:

↳ Radio ▶▶  Presets

Moving stations:

- ▶ Highlight a preset entry and navigate to the left.

- ▶ Select **Move Highlighted Station**.
- ▶ Select a memory preset.

Deleting stations:

- ▶ Highlight a preset entry and navigate to the left.
- ▶ Select **Delete Highlighted Station**.
- ▶ Select **Yes**.

Tagging music tracks

Multimedia system:



Radio

If radio stations provide the relevant information, this function allows you to transfer information on the music track currently playing to an Apple® device. You can then purchase the audio file from the iTunes Store®.

- ▶ Select **Tag This Song**.
The track information is saved.

Activating/deactivating radio text

Multimedia system:



Radio



Options



Display Radio Text Information

- ▶ Activate or deactivate the function.

Satellite radio

Information on the satellite radio

SIRIUS XM® satellite radio offers more than 175 digital-quality radio channels providing 100% commercial-free music, sports, news and entertainment, for example. SIRIUS XM satellite radio employs a fleet of high-performance satellites to broadcast around the clock throughout the USA and Canada. The satellite radio program is available for a monthly fee. Information about this can be obtained from a Sirius XM® Service Center and at <http://www.siriusxm.com> (USA) or <http://www.siriusxm.ca> (Canada).

- ⓘ Sirius, XM and all related marks and logos are trademarks of Sirius XM Radio Inc. and its subsidiaries. All other marks, channel

names and logos are the property of their respective owners. All rights reserved.

Satellite radio restrictions

Satellite radio mode may be temporarily unavailable or interrupted for a variety of reasons. These include environmental or topographical conditions beyond the control of Mercedes-Benz USA, LLC. Thus, operation at certain locations may not be possible.

Registering satellite radio

Requirements:

- Satellite radio equipment
- Registration with a satellite radio provider
- If registration is not included when purchasing the system, your credit card details will be required to activate your account

Multimedia system:

↳ Radio ▶▶  Radio Source
▶▶ SiriusXM Radio ▶▶  Options

▶ Select **Service Information**.

The service information screen appears showing the radio ID and the current subscription status.

▶ Establish a telephone connection.

▶ Follow the service staff's instructions.
The activation process may take up to ten minutes.

 You can also have the satellite service activated online. To do so, please visit <http://>

www.siriusxm.com (USA) or <http://www.siriusxm.ca> (Canada).

Switching on satellite radio

Multimedia system:

↳ Radio ▶▶  Radio Source

▶ Select **SiriusXM Radio**.

Overview of the satellite radio

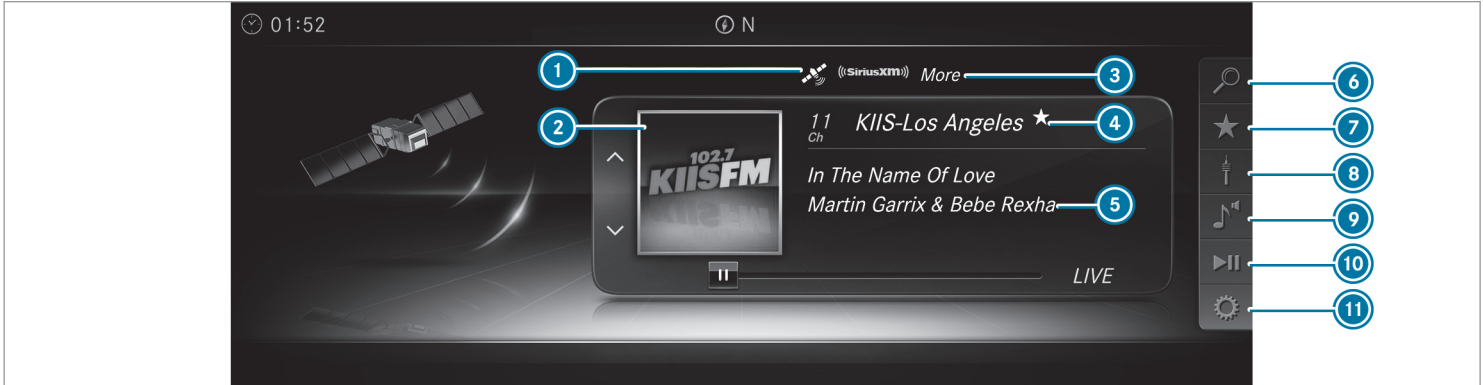



- ① Active frequency band
- ② Logo or album art (if available)
- ③ Category
- ④ Channel name

- ⑤ Artist, track and album
- ⑥ SiriusXM Radio Channels
- ⑦ Presets
- ⑧ Radio Source

- ⑨ Sound
- ⑩ Playback Control
- ⑪ Options

Selecting a satellite radio category

Multimedia system:

- ↳ Radio ▶▶  Radio Source
- ▶▶ SiriusXM Radio
- ▶▶  SiriusXM Radio Channels ▶▶ Category
- ▶ Select a category.

Selecting a satellite radio channel

Multimedia system:

- ↳ Radio ▶▶  Radio Source
- ▶▶ SiriusXM Radio
- ▶ Navigate up or down.

Saving or deleting a satellite radio channel

Multimedia system:

- ↳ Radio ▶▶  Radio Source
- ▶▶ SiriusXM Radio ▶▶  Presets
- ▶ Select Store Current Station in the Presets.

Moving a channel

- ▶ Select Options.
- ▶ Select Move Highlighted Station.
- ▶ Select a memory preset.

Deleting a channel

- ▶ Select Delete Highlighted Station.
- ▶ Select a memory preset.



Displaying EPG information for the current channel

Multimedia system:

- ↳ Radio ▶▶  Radio Source
- ▶▶ SiriusXM Radio ▶▶  Options
- ▶ Select EPG Information about Current Channel.

Setting parental control for radio

Multimedia system:

- ↳ Radio ▶▶  Radio Source
- ▶▶ SiriusXM Radio ▶▶  Options
- ▶▶ Parental Control
- ▶ Activate the function .
- ▶ Determine a four-digit character sequence and select .
- ▶ All channels with adult content are locked.

Unlocking a channel



- ▶ Enter the four-digit character sequence and select .
- ▶ All channels with adult content are unlocked.

Music and sport alerts function

This function enables you to program an alert for your favorite artists, tracks or sporting events. Music alerts can be saved whilst a track is being played and sport alerts can be saved during a live game. You can also specify sport alerts via the menu option. The system then continuously searches through all the channels. If a match is found with a stored alert, you will be informed.

Setting music and sport alerts

Multimedia system:

- ↳ Radio ▶▶  Radio Source
- ▶▶ SiriusXM Radio ▶▶  Options
- ▶▶ Alert for Artist, Song & Sporting Event

Setting a music alert

- ▶ Select Add New Alert.
- or
- ▶ Select Manage Artist & Song Alerts.

▶ Select  **Options**.

The following options are available:

- [Mark This Entry](#)
- [Unmark This Entry](#)
- [Mark All Entries](#)
- [Unmark All Entries](#)
- [Delete This Entry](#)
- [Delete All Entries](#)

▶ Select an option.

▶ [Activate Artist & Song Alerts](#) .

The alert is set for the current artist or track. If a match is found, a prompt appears asking whether you wish to change to the station.

Setting a sport alert

▶ Select [Add New Alert](#).

or

▶ Select [Manage Sports Alerts](#).

▶ Select [Select New Alerts](#).

or

▶ Select [Edit Alerts](#).

▶ Select a team from a league.

▶ [Activate Sports Alerts](#) .

Information on Smart Favorites and Tune Start

Stations in the station presets can be added as Smart Favorites. Smart Favorites stations are automatically saved to temporary storage in the background. If you change to a Smart Favorites station, you can replay, pause or actively skip forward or back to broadcasts which you have missed. If Tune Start is activated and you change to another Smart Favorites station, the music track currently playing on the station is automatically restarted from the beginning of the track.

Adding a channel to Smart Favorites

Multimedia system:

 [Radio](#) ▶▶  [Radio Source](#)

▶▶ [SiriusXM Radio](#)

▶ Select the active frequency band.

▶ Highlight an entry.

▶ Select .

▶ Select [Add Highlighted Channel to Smart Favorites](#).

Activating/deactivating TuneStart

Multimedia system:

 [Radio](#) ▶▶  [Options](#) ▶▶ [TuneStart](#)

▶ Activate or deactivate the function.

Controlling playback

Multimedia system:

 [Radio](#) ▶▶  [Playback Control](#)

You can pause the playback of the current station or skip forward or backward in the timeline. This leaves live mode to access the internal temporary storage.

▶ **To fast forward/rewind:** turn the controller counter-clockwise or clockwise/swipe left or right on the touchpad.

▶ **To jump to the previous/next song:** press the controller left or right/swipe left or right on the touchpad.

▶ **To pause playback:** select .

▶ **To return to live mode:** navigate to the end of the timeline.

Displaying satellite radio service information

Multimedia system:

- ↳ Radio >>  Radio Source
- >> SiriusXM Radio >>  Options

- ▶ Select Service Information.

Sound

Tone settings

Information about the sound system

The sound system has a total output of 100 W and is equipped with 6 speakers. It is available for all functions in the radio and media modes.

Calling up the sound menu

Multimedia system:

- ↳ Media >>  Sound

The following functions are available:

- Equalizer
- Balance and Fader
- Automatic Volume Adjustment
- Other Sound Settings

- ▶ Select a sound menu.

Adjusting treble, mid-range and bass settings

Multimedia system:

- ↳ Media >>  Sound >> Equalizer

- ▶ Select Treble, Mid Range or Bass.

- ▶ Change the settings.

Activating/deactivating automatic volume adjustment

Multimedia system:

- ↳ Media >>  Sound
- >> Automatic Volume Adjustment

Automatic volume adjustment compensates for differing volumes when changing between audio sources.

- ▶ Activate or deactivate the function.

Adjusting the balance/fader

Multimedia system:

- ↳ Media >>  Sound
- >> Balance and Fader

- ▶ Adjust the balance and fader.

- ▶ **To exit the menu:** press the  button.

Burmester® surround sound system

Information about the Burmester® surround sound system

The Burmester® surround sound system has a total output of 590 W and is equipped with 15 speakers. It is available for all functions in the radio and media modes.

Calling up the sound menu in the Burmester® surround sound system

Multimedia system:

- ↳ Media >>  Sound

The following functions are available:

- Equalizer
- Balance and Fader
- Automatic Volume Adjustment
- Surround Sound
- Sound Focus
- Other Sound Settings

- ▶ Select a function.

Adjusting the treble, mid and bass settings on the Burmester® surround sound system

Multimedia system:

↳ Media ▶▶  Sound ▶▶ Equalizer

▶ Select **Treble**, **Mid Range** or **Bass**.

▶ Set the desired values.

Activating/deactivating volume adjustment in the Burmester® surround sound system

Multimedia system:

↳ Media ▶▶  Sound

▶▶ Automatic Volume Adjustment

Automatic volume adjustment compensates for differing volumes when changing between audio sources.

▶ Activate or deactivate the function.

Adjusting the balance/fader in the Burmester® surround sound system

Multimedia system:

↳ Media ▶▶  Sound

▶▶ Balance and Fader

▶ Adjust the balance and fader.

▶ To exit the menu: press the  button.

Switching surround sound on/off in the Burmester® surround sound system

Multimedia system:

↳ Media ▶▶  Sound

▶▶ Surround Sound

▶ Activate or deactivate the function.

Adjusting the sound focus in the Burmester® surround sound system

Multimedia system:

↳ Media ▶▶  Sound ▶▶ Sound Focus

▶ Adjust the sound focus.

Rear Seat Entertainment System

Notes on operating safety

⚠ WARNING Risk of accident or injury due to the driver operating the Rear Seat Entertainment System

If you operate the Rear Seat Entertainment System when driving you could lose control of the vehicle.

- ▶ Only have the Rear Seat Entertainment System operated by rear compartment passengers when they have their seat belts fastened.
- ▶ Set the volume on the Bluetooth® speakers so that sounds, in particular from outside the vehicle, can always be heard.

⚠ WARNING Risk of accident or injury due to incorrect modifications of the Rear Seat Entertainment System

The Rear Seat Entertainment System contains no parts that can be maintained by you. Modifications to the Rear Seat Entertainment System can impair its function and/or the function of additionally networked components.

- ▶ Always have maintenance work and repairs carried out at a qualified specialist workshop.

⚠ WARNING Risk of injury from unsecured items in the vehicle

If objects such as headphones/headsets or external audio/video sources are not secured in the vehicle interior, they can be flung around and hit vehicle occupants.

- ▶ Always stow these items or similar objects carefully so that they cannot be flung around, for example in a lockable vehicle stowage compartment.

Observe the notes on loading the vehicle.

⚠ WARNING Risk of accident and injury caused by spilling liquids on a display

Spilled liquids could result in a fire or an electric shock.

- ▶ Do not pour or spray any liquids onto the display.

! NOTE Damage to the rear display and/or the rear bench seat

The rear displays of the Rear Seat Entertainment System and/or the rear bench seat can be damaged when folding the rear bench seat forwards.

- ▶ Make sure that when folding the rear bench seat forwards it does not come into contact with the rear displays and the front seats.

! NOTE Damage to component parts when adjusting the front seats

The rear displays of the Rear Seat Entertainment System, the front seats or other component parts can be damaged when adjusting the front seats.

- ▶ When adjusting the front seats and the installed rear displays make sure that they do not come into contact with other component parts.

Observe the notes on adjusting the front seats.

Function restrictions

Radio-based electronic devices, e.g. mobile phones, can interfere with the Rear Seat Entertainment System and adversely affect the quality of the playback. Keep the number of these devices in the vehicle to the minimum necessary.

Notes on temperatures: in the event that a rear display overheats a safety shutoff is carried out. Protect the rear displays from constant direct sunlight.

If the temperature fluctuates widely, condensation could occur on the inside of the screen. This can adversely affect the function. Only switch on the rear displays when they have adjusted to the ambient temperature.

Declarations of conformity

Observe the declaration of conformity for "wireless vehicle components" (→ page 23).

Rear Seat Entertainment System overview

The Rear Seat Entertainment System can be operated both in the vehicle as well as outside the vehicle.

The Rear Seat Entertainment System includes:

- Two rear displays (Dual System) or one rear display (Single System)
- Connection for corded headphones for each rear display
- Connections for USB (type A) and HDMI on the rear display

i For playback, you can use commercially available corded headphones, Bluetooth®

headphones or Bluetooth® speakers (see the manufacturer's operating instructions). When using headsets disturbance to playback may occur.

- i** The Rear Seat Entertainment System can be connected and operated with an external remote control via Bluetooth® (see the manufacturer's operating instructions).
- i** To operate the Rear Seat Entertainment System outside the vehicle, a 12 V (1.5 A) adapter cable for power supply is required (see the manufacturer's operating instructions).
- i** The functions of the remote control, the cordless headphones or speakers can be impaired by other radio-based electronic devices, e.g. mobile phones.

Rear displays

Overview of the rear displays

Control elements

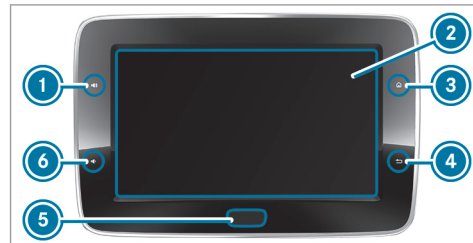

- 1** Increases the volume
- 2** Touchscreen
Display type: TFT LCD with 10.1 inch (25.7 cm) screen size
Resolution (horizontal x vertical): 1024 x 600 pixels
- 3** Calls up the main menu
- 4** Back button

- ⑤ Switches the rear display on or off
- ⑥ Lowers the volume

Ports

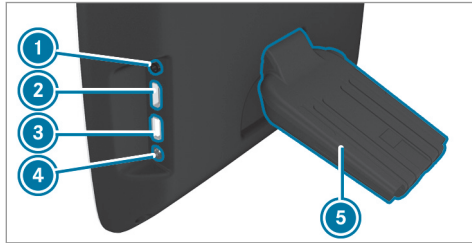

- ① Connection for 12 V power supply (1.5 A) for operation outside the vehicle
- ② HDMI socket
- ③ USB port, type A
- ④ Socket for corded headphones with 3-pin jack (3.5 mm, stereo)
- ⑤ Foot (for inserting a rear display into the console)

- ⓘ The consoles for accommodating the rear displays are located on the rear of the front seats.

Inserting a rear display in the console

⚠ WARNING Risk of injury caused by faulty attachment of the display

Incorrectly attached or damaged rear displays can, for example, break loose and be thrown around injuring occupants in the following situations:

- During heavy braking
 - In the event of a sudden change of direction
 - In the event of an accident
- ▶ Before every journey check that the rear displays are firmly attached.
 - ▶ If necessary, insert the rear display into the console again.
 - ▶ Do not use a damaged rear display.

- ▶ **Before installing a rear display:** remove all objects, for example clothes hangers, from the head restraint bars.

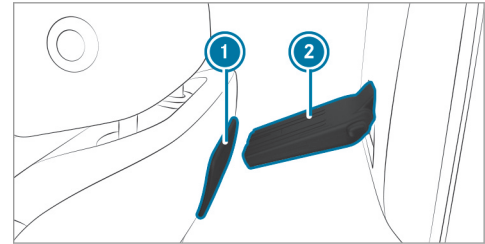

- ▶ Hold foot ② of the rear display on to console cover ①.
- The cover releases automatically when it is into contact with the foot.
- ▶ Insert foot ② of the rear display into console ①.
- Foot ② engages audibly.

Removing the rear display from the console

⚠ WARNING Risk of injury through displays mounted in the vehicle

The rear displays installed in the vehicle could injure the rear seat occupants, for example in the following situations:

- During heavy braking
- Sudden change of direction
- In the event of an accident

▶ Remove the rear displays from the vehicle each time after using and store safely.

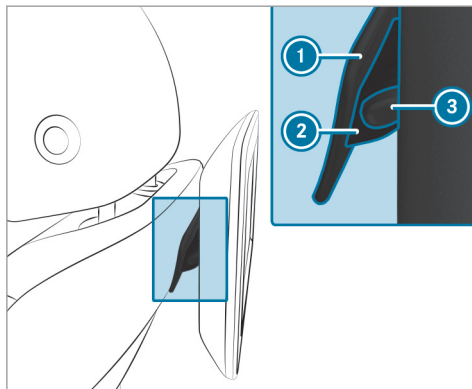

- ▶ Press button ③ and remove rear display foot ② from console ①.

Switching a rear display on/off

Activating

- ▶ Switch on the power supply or the ignition using the start/stop button (→ page 126).

- ▶ Press and hold button ⑤ on the rear display until the symbols at the side light up (→ page 324). During the charging process a charging symbol appears at the top left of the status line.
- ▶ **When the Rear Seat Entertainment System is used for the first time or after a reset to the factory settings:** select the system language.
- ▶ Set the device search name.

ⓘ The device name consists of between 3 and 16 characters. The rear displays have different names.



Switching off

- ▶ Press and hold button ⑤ on the rear display for about three seconds (→ page 324). Media playback is ended and must be restarted when it is switched on.
- ⓘ When the vehicle ignition is switched off, the rear displays are also switched off.

Starting standby mode

- ▶ **On the rear display:** briefly press button . The signal to the rear display is switched off. Media playback is stopped.

Ending standby mode

- ▶ **On the rear display:** press button .
- ▶ Continue media playback with .

Eliminating problems with switching on

If no signal appears in the rear display, carry out the following steps.

- ▶ Switch on the ignition.

or

- ▶ Check the connection to externally connected devices.

or

- ▶ Remove the rear display from the console (→ page 326).
- ▶ Clean the contacts.
- ▶ Insert the rear display into the console (→ page 325).

or

- ▶ Have the fuses for the vehicle seat checked at an authorized Mercedes-Benz Center.

Operating a rear display

- ▶ **To select a menu:** briefly tap on the touchscreen.
- ▶ **To scroll in lists:** slowly move the scroll bar up or down.
- ▶ **To exit the menu:** press the  button.

Cleaning the rear display

⚠ WARNING Risk of accident and injury caused by spilling liquids on a display

Spilled liquids could result in a fire or an electric shock.

- ▶ Do not pour or spray any liquids onto the display.

- ▶ Switch off the rear display and let it cool down.
- ▶ Use a soft, lint-free cloth, moistened with water.

Overview of the Rear Seat Entertainment System homescreen

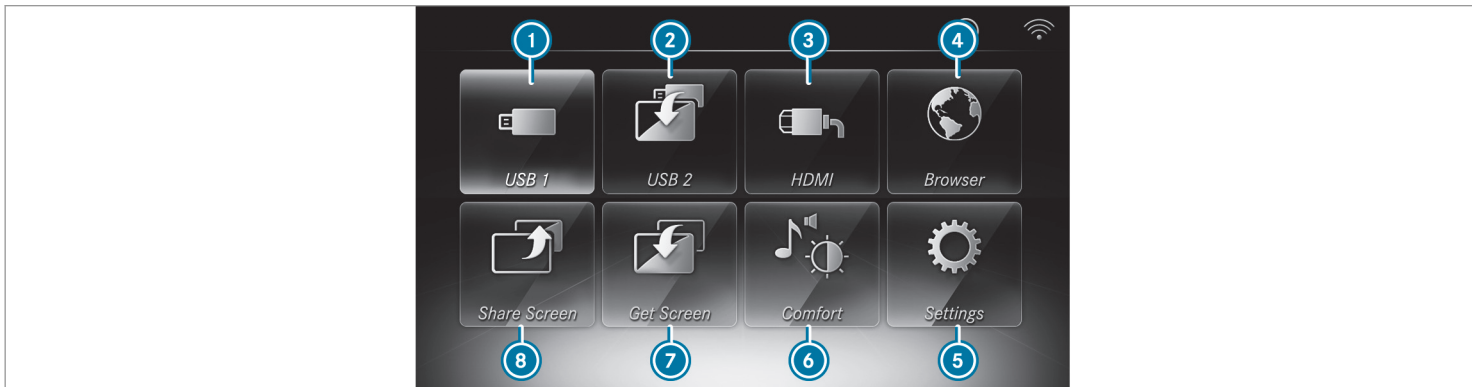

- ① To access media from a USB device connected to a rear display
- ② To access media from a USB device connected to the other rear display
- ③ To access media from a device connected via HDMI

- ④ To open a browser
- ⑤ To open system settings
- ⑥ To open comfort settings (→ page 330)
- ⑦ To show the picture from the other rear display (→ page 330)

- ⑧ To share the picture with the other rear display (→ page 330)

Headphones

Overview of the headphones for the Rear Seat Entertainment System

⚠ WARNING Risk of injury due to high volume of the headphones

Your hearing can be damaged when exposed to high volumes.

- ▶ Make sure that the volumes at the rear displays are set to a comfortable level before putting on the headphones.

For each rear display you can connect the following accessories:

- Bluetooth® headphones or a Bluetooth® speaker
 - Corded headphones via a 3-pin stereo jack, 3.5 mm
- i** The accessories can be obtained at a specialist shop (see the manufacturer's operating instructions).

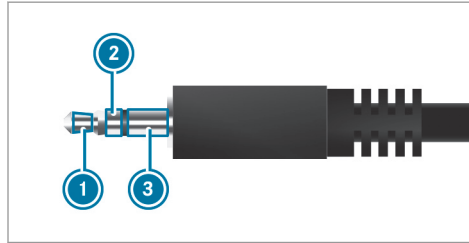

Connection of corded headphones with a 3-pin stereo jack, 3.5 mm

- ① Audio L (audio signal for left channel)
- ② Audio R (audio signal for right channel)
- ③ Earth

Connecting Bluetooth® headphones with the Rear Seat Entertainment System

- ▶ **On the headphones or speaker:** switch on Bluetooth®.
- ▶ If necessary, activate pairing mode (see the manufacturer's operating instructions).
- ▶ **On the rear display:** select .

- ▶ Select **Settings**.
- ▶ Select **Pairing**.
- ▶ Select **Turn Bluetooth On**.
- ▶ Select the device to be connected in the Bluetooth® device list. When the device is connected, the headphones symbol appears at the top right of the status bar.

Disconnecting Bluetooth® headphones from the Rear Seat Entertainment System

- ▶ **On the rear display:** select .
- ▶ Select **Settings**.
- ▶ Select **Pairing**.
- ▶ Select the device to be disconnected in the Bluetooth® device list.
- ▶ Select **Disconnect**.

Setting the volume and brightness

Rear Seat Entertainment System:

↳ Comfort

Setting the sound

- ▶ Select **Sound**.
- ▶ Select **Volume**.
- ▶ Set the volume.

or

- ▶ Select **Equalizer**.
- ▶ Set the treble and bass.

Adjusting the brightness

- ▶ Select **Brightness**.
- ▶ Set the screen brightness.

i Settings for sound and brightness can be carried out individually for both rear displays.

Setting the system language for the rear display

Rear Seat Entertainment System:

↳ Settings ▶ Language

▶ The desired system language is set.

Setting the Rear Seat Entertainment System connections

Rear Seat Entertainment System:

↳ Settings

Wi-Fi settings

▶ Select **Wi-Fi**.

The following menus are available:

- **Access Point Mode**

In this menu you can set the search name of the device as well as the password for Wi-Fi security. For sufficient security you should use a password with 8-16 characters.

- **Wi-Fi Connection**

In this menu you can switch the Wi-Fi on/off as well as set automatic and manual connection to available networks.

i Where there is active Wi-Fi the  symbol is shown at the top right of the status bar.

Pairing settings (Bluetooth®)

▶ Select **Pairing**.

The following functions are available:

- Activating/deactivating Bluetooth®
- Pairing/disconnecting Bluetooth devices (e.g. Bluetooth headphones)

i If the Rear Seat Entertainment System is reset to the factory settings, the Wi-Fi and pairing settings are also reset. Further information on resetting to the factory settings (→ page 331).

Sharing playback with a rear display

Requirements for playback of a mobile end device via the rear display:

- The end device is DLNA compatible.

- A DLNA compatible app is installed on the end device.

Rear Seat Entertainment System:

↳ Wi-Fi ▶ Wi-Fi Connection

Sharing playback from a mobile end device with a rear display

Using a Wi-Fi connection you can playback media from your mobile end device (e.g. images, videos or music) on a rear display.

- ▶ Establish the Wi-Fi connection between the rear display and the end device.
- ▶ Activate a DLNA compatible app on the end device (see the manufacturer's instructions).
- ▶ Enable the desired media content on the end device.
The media is played back on the rear display.

Sharing playback from one rear display with the other rear display

- ▶ **On the transmitting rear display:** select [Activate Access Point](#).

- ▶ **On the receiving rear display:** select the transmitting rear display from the list of available end devices and enter the password. The connection between both rear displays is established.

- ▶ **On the transmitting rear display:** select [Share Screen](#) on the homescreen.

- ▶ Select [Share](#).

- ▶ **On the receiving rear display:** select [Get Screen](#) on the homescreen.

- ▶ Select [Accept](#).

- ▶ **On the transmitting rear display:** press the  button. The same picture appears on both rear displays.

Ending sharing of a screen

- ▶ **On the transmitting rear display:** select [Share Screen](#).

- ▶ Select [Cancel](#).

Searching for software updates

Rear Seat Entertainment System

↳ [Settings](#)

- ▶ Select [Update](#).
New software updates can be searched for in this menu. If new updates are available these can be downloaded and installed.

Resetting the rear display settings

Rear Seat Entertainment System:

↳ [Settings](#)

- ▶ Select [Factory Reset](#).
In this menu the system can be reset to the factory settings. In the process, all Wi-Fi access points, Bluetooth devices and comfort settings are also reset.

Showing system information for the rear display

Rear Seat Entertainment System:

→ Settings

▶ Select **About**.

The following information is shown:

- Technical information
- Software version
- Memory preset
- Serial number

Media

Information about media mode in the Rear Seat Entertainment System

There is one USB port (type A) and one HDMI connection in the Rear Seat Entertainment System (→ page 324).

Data storage media and devices supported by the Rear Seat Entertainment System:

- USB storage device
- iPod®

- iPhone®
- MTP devices

Audio formats supported by the Rear Seat Entertainment System:

- MPEG-2
- MP3
- WMA
- ACC
- WAV
- FLAC
- OGG

Video formats supported by the Rear Seat Entertainment System:

- MPEG-1 and MPEG-4
- DivX
- Xvid
- WMV
- H.264
- MKV
- FLV

Image formats supported by the Rear Seat Entertainment System:

- JPEG
- GIF
- PNG
- BMP

The Rear Seat Entertainment System supports a total of up to 50,000 files.

Further information about audio mode (→ page 300).



Manufactured under license from Dolby Laboratories. Dolby, Dolby Audio and the double-D symbol are trademarks of Dolby Laboratories.

Playback takes place via USB storage media, the HDMI connection or via the Internet.



The terms HDMI and HDMI High-Definition Multimedia Interface, and the HDMI Logo are trademarks or registered trademarks of HDMI Licensing LLC in the United States and other countries. Playback is carried out via devices with an HDMI connection.

- i Playback via Apple® devices, e.g. an iPhone®, requires an MHL adapter. MHL stands for **M**obile **H**igh-Definition **L**ink.



For DTS Patents, see <http://patents.dts.com>. Manufactured under license from DTS Licensing Limited. DTS, DTS-HD, the Symbol, & DTS and the Symbol together are registered trademarks of DTS, Inc.® DTS, Inc. All rights reserved.

Playback takes place via USB storage media, the HDMI connection or via the Internet.

Switching to media mode on the Rear Seat Entertainment System

Media can be played back on one rear display or on two rear displays of the Rear Seat Entertainment System.



- ▶ Switch on one Rear Seat Entertainment System screen.
The homescreen appears.
- ▶ Select a data source.
- ▶ Select the **Music**, **Videos** or **Photos** category.
All files in the desired category are shown in alphabetical order.

i The Rear Seat Entertainment System can be operated with the buttons on the screen (→ page 324) or with the touchscreen.

Media playback via HDMI devices can only be controlled using the buttons on the screen as well as on the end device connected.

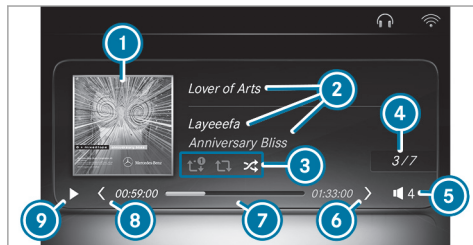
Overview of media playback on the Rear Seat Entertainment System



- 1** Album cover
- 2** Track, artist, album
- 3** Playback mode
-  Single repeat within the playback list
-  : Unlimited repeats within the playback list
-  : Random playback within the playback list
- 4** Media number and number of media in the playback list
- 5** Currently set volume



For video playback: additional display of the currently set brightness

For image playback: only display of the currently set brightness

- 6** Switches to the next file
- 7** Timeline

For image playback: current image number/number of images in the selected folder

- 8** Switches to the previous file
- 9** Playback mode



-  Playback is paused. Touch the touchscreen to start the file/slide show
-  Playback is active. Touch the touchscreen to pause playback

i For playback of video and images the information shown is reduced.

i For content that is transmitted to the rear display via Wi-Fi connection: Operation is carried out on the connected end device (see the manufacturer's operating instructions). The volume can be set using the buttons on the rear display.

Controlling media playback in the Rear Seat Entertainment System



Starting/stopping playback

- ▶ Tap  on the touchscreen. Playback starts.
- ▶ Tap  on the touchscreen. Playback pauses.

Fast rewind/forward



- ▶ Move the yellow playback bar on the touchscreen to the left or right. Playback of the file is continued from the selected position.

Playing the previous or next file



- ▶ Tap  (back) or  (forwards) on the touchscreen. With every tap you skip one file backwards or forwards.

Adjusting the volume

- ▶ Tap  on the touchscreen.

- ▶ Tap  (quieter) or  (louder) to adjust the volume.

Adjusting the brightness

- ▶ Tap  on the touchscreen.
- ▶ Tap  (brighter) or  (darker) to adjust the brightness.

ASSYST PLUS service interval display

Function of the ASSYST PLUS service interval display

The ASSYST PLUS service interval display on the Instrument Display provides information on the remaining time or distance before the next service due date.

You can hide this service message using the back button on the left-hand side of the steering wheel.

Depending on how the vehicle is used, the ASSYST PLUS service interval display may shorten the service interval, e.g. in the following cases:

- Mainly short-distance driving
- When the engine is often left idling for long periods
- In the event of frequent cold start phases

Mercedes-Benz recommends avoiding such operating conditions.

You can obtain further information concerning the servicing of your vehicle from a qualified

specialist workshop, e.g. an authorized Mercedes-Benz Center.

Displaying the service due date

On-board computer:

↪ Service ▶ ASSYST PLUS

The next service due date is displayed.

▶ **To exit the display:** press the back button on the left-hand side of the steering wheel.

Make sure to observe the following further related subject:

- Operating the on-board computer (→ page 202).

Information on regular maintenance work

! **NOTE** Premature wear through failure to observe service due dates

Service work which is not carried out at the right time or incompletely can lead to increased wear and damage to the vehicle.

- ▶ Always observe the prescribed service intervals.
- ▶ Always have the prescribed service work carried out at a qualified specialist workshop.

Special service requirements

The prescribed service interval is based on normal operation of the vehicle. Maintenance work will need to be performed more often if the vehicle is operated under arduous conditions or increased loads.

The ASSYST PLUS service interval display is only an aid. The driver of the vehicle bears responsibility as regards to whether maintenance work needs to be performed more often than specified based on the actual operating conditions and/or loads.

Examples of arduous operating conditions:

- regular city driving with frequent intermediate stops
- mainly short-distance driving

- frequent operation in mountainous terrain or on poor road surfaces
- when the engine is often left idling for long periods
- operation in particularly dusty conditions and/or if air-recirculation mode is frequently used

In these or similar operating conditions, have the interior air filter, engine air cleaner, engine oil and oil filter etc. changed more frequently. The tires must be checked more frequently if the vehicle is operated under increased loads. Further information can be obtained at a qualified specialist workshop.

Battery disconnection periods

The ASSYST PLUS service interval display can only calculate the service due date when the battery is connected.

- ▶ Note down the service due date displayed on the instrument display before disconnecting the battery (→ page 336).

Engine compartment

Opening/closing the hood

- ⚠ **WARNING** Risk of accident if the engine hood is unlatched while driving

An unlocked engine hood may open up when the vehicle is in motion and block your view.

- ▶ Never unlatch the engine hood while driving.
- ▶ Before every trip, ensure that the engine hood is latched.

- ⚠ **WARNING** Risk of accident and injury when opening and closing the engine hood

When opening or closing the engine hood, it may suddenly drop into the end position.

There is a risk of injury for anyone in the engine hood's range of movement.

- ▶ Only open or close the engine hood when there are no persons in the engine hood's range of movement.

- ⚠ **WARNING** Danger of burns when opening the hood

If you open the hood when the engine has overheated or during a fire in the engine compartment, you could come into contact with hot gases or other escaping operating fluids.

- ▶ Before opening the hood, allow the engine to cool down.
- ▶ In the event of a fire in the engine compartment, keep the hood closed and call the fire service.

- ⚠ **WARNING** Risk of injury due to moving parts

Certain components in the engine compartment may continue to move or suddenly move again even after the ignition has been switched off, e.g. the cooler fan.

Make sure of the following before performing tasks in the engine compartment:

- ▶ Switch the ignition off.

- ▶ Never touch the danger zone surrounding moving component parts, e.g. the rotation area of the fan.
- ▶ Remove jewelry and watches.
- ▶ Keep items of clothing and hair away from moving parts.

⚠ WARNING Risk of injury from touching component parts under voltage

The ignition system and the fuel injection system work under high voltage. If you touch component parts which are under voltage, you could receive an electric shock.

- ▶ Never touch component parts of the ignition system or the fuel injection system when the ignition is switched on.

⚠ WARNING Risk of burns from hot component parts in the engine compartment

Certain components in the engine compartment can be very hot, e.g. the engine, the radiator and parts of the exhaust system.

- ▶ Allow the engine to cool down and only touch component parts described in the following.

⚠ WARNING Risk of injury from using the windshield wipers while the engine hood is open

When the engine hood is open and the windshield wipers are set in motion, you can be trapped by the wiper linkage.

- ▶ Always switch off the windshield wipers and ignition before opening the engine hood.

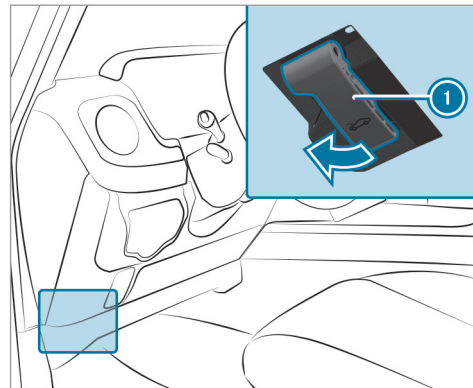

- ▶ **To open:** pull lever ① to release the hood.

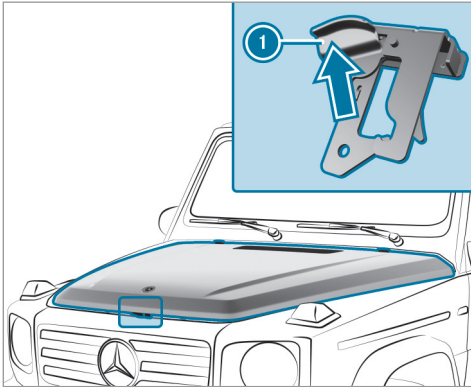

- ▶ Push handle ① of the hood catch upwards and lift the hood by approximately 15 in (40 cm). The hood will be opened and held open automatically by the pneumatic spring.
- ▶ **To close:** lower the hood until the hood catch engages.
- ▶ Then, press the hood firmly into the lock with both hands until it is completely closed.

- ▶ If the hood can still be lifted slightly, open the hood again and repeat the previous step until it engages correctly.

Engine oil

Checking the engine oil level using the on-board computer

Requirements

The engine oil level is determined during driving. Determining the engine oil level can take up to 30 minutes with a normal driving style and even longer with an active driving style.

In order to receive a result as quickly as possible:

- Warm up the engine
- Park the vehicle on a level surface
- Leave the engine running at idling speed

On-board computer:

➔ **Service** ➔ **Engine Oil Level**

You will see one of the following messages on the multifunction display:

- **Measuring Engine Oil Level...:** measurement of the oil level is not yet possible.
- ▶ Repeat the request after a maximum of 30 minutes driving.
- **Engine Oil Level OK** and the bar display for indicating the oil level on the multifunction display is green and is between "min" and "max": the oil level is correct.
It is necessary to fill the engine oil to "max" before off-road driving.
- ▶ If the bar is at "min": add approx. 1.1 US qt (1 l) engine oil.
- ▶ If the bar is in the middle: add approx. 0.5 US qt (0.5 l) engine oil.
- **Engine Oil Level Add 1.0 l** and the bar display for indicating the oil level on the multifunction display is orange and is below "min":

- ▶ Add 1.1 US qt (1 l) engine oil.
 - **Reduce Engine Oil Level** and the bar display for indicating the oil level on the multifunction display is orange and is above "max":
- ▶ Drain off excess engine oil that has been added. Consult a qualified specialist workshop.
 - **For Engine Oil Level Switch Ignition On:**
- ▶ Switch on the ignition to check the engine oil level.
 - **Engine Oil Level System Inoperative:** sensor faulty or not inserted.
- ▶ Consult a qualified specialist workshop.
 - **Engine Oil Level System Currently Unavail.:**
- ▶ Close the hood.

Adding engine oil

⚠ WARNING Risk of burns from hot component parts in the engine compartment

Certain components in the engine compartment can be very hot, e.g. the engine, the radiator and parts of the exhaust system.

- ▶ Allow the engine to cool down and only touch component parts described in the following.

⚠ WARNING Risk of fire and injury from engine oil

If engine oil comes into contact with hot component parts in the engine compartment, it may ignite.

- ▶ Make sure that no engine oil is spilled next to the filler opening.
- ▶ Allow the engine to cool off and thoroughly clean the engine oil from component parts before starting the vehicle.

! NOTE Engine damage caused by an incorrect oil filter, incorrect oil or additives

- ▶ Do not use engine oils or oil filters which do not correspond to the specifications explicitly prescribed for the service intervals.
- ▶ Do not alter the engine oil or oil filter in order to achieve longer change intervals than prescribed.
- ▶ Do not use additives.
- ▶ Follow the instructions in the service interval display regarding the oil change.

! NOTE Damage caused by adding too much engine oil

- Too much engine oil can damage the engine or the catalytic converter.
- ▶ Have excess engine oil removed at a qualified specialist workshop.

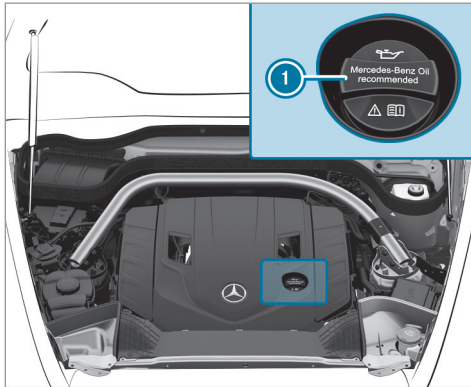

- ▶ Turn cap ① counter-clockwise and remove it.
- ▶ Add engine oil.
- ▶ Replace cap ① and turn it clockwise as far as it will go.
- ▶ Check the oil level again (→ page 339).

Checking coolant level

⚠ WARNING Risk of burns from hot component parts in the engine compartment

Certain components in the engine compartment can be very hot, e.g. the engine, the radiator and parts of the exhaust system.

- ▶ Allow the engine to cool down and only touch component parts described in the following.

⚠ WARNING Risk of scalding from hot coolant

The engine cooling system is pressurized, particularly when the engine is warm. If you open the cap, you could be scalded by hot coolant spraying out.

- ▶ Let the engine cool down before opening the cap.
- ▶ When opening the cap, wear protective gloves and safety glasses.
- ▶ Open the cap slowly to release pressure.

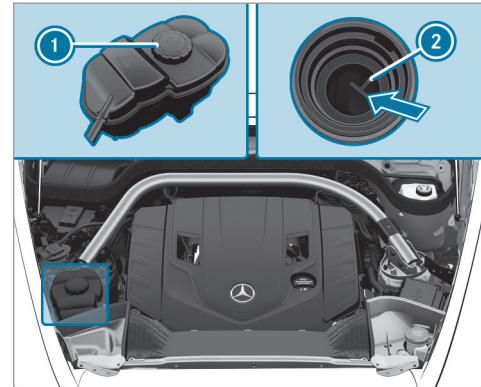

- ▶ Park the vehicle on a level surface.
- ▶ Check the coolant temperature display in the instrument cluster. The coolant temperature must be below 158 °F (70 °C).
- ▶ Slowly turn cap ① counter-clockwise to release overpressure.

- ▶ Continue turning cap ① counter-clockwise and remove it.

The coolant level is correct:

- if the engine is cold, up to marker bar ②
 - If the engine is warm, up to 0.6 in (1.5 cm) over marker bar ②
- ▶ If necessary, add coolant that has been approved by Mercedes-Benz.
- Further information on coolant (→ page 407).

Adding washer fluid to the windshield washer system

- ⚠ **WARNING** Risk of burns from hot component parts in the engine compartment

Certain components in the engine compartment can be very hot, e.g. the engine, the radiator and parts of the exhaust system.

- ▶ Allow the engine to cool down and only touch component parts described in the following.

- ⚠ **WARNING** Danger of burns when opening the hood

If you open the hood when the engine has overheated or during a fire in the engine compartment, you could come into contact with hot gases or other escaping operating fluids.

- ▶ Before opening the hood, allow the engine to cool down.
- ▶ In the event of a fire in the engine compartment, keep the hood closed and call the fire service.

- ⚠ **WARNING** - Risk of fire and injury from windshield washer concentrate

Windshield washer concentrate is highly flammable. It could ignite if it comes into contact with hot engine component parts or the exhaust system.

- ▶ Make sure that no windshield washer concentrate spills out next to the filler opening.

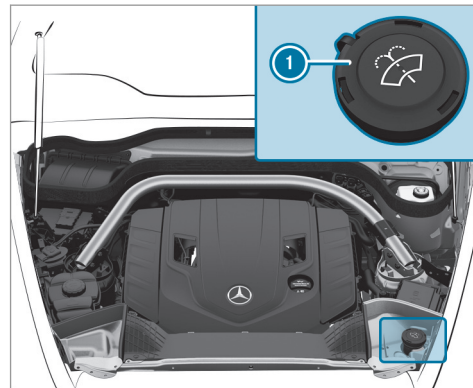

- ▶ Turn cap ① counter-clockwise and remove it.
- ▶ Add washer fluid.
- ▶ Replace cap ① and turn it clockwise as far as it will go.

Keeping the air-water duct free

- ▶ Keep the area between the hood and the windshield free of deposits, e.g. ice, snow and leaves.

Cleaning and care

Information on washing the vehicle in a car wash

⚠ WARNING Risk of accident due to reduced braking effect after washing the vehicle

The braking effect is reduced after washing the vehicle.

- ▶ After the vehicle has been washed, brake carefully while paying attention to the traffic conditions until the braking effect has been fully restored.

! **NOTE** Damage due to unsuitable car wash

- ▶ Before driving into a car wash make sure that the car wash is suitable for the vehicle dimensions.
- ▶ Ensure there is sufficient ground clearance between the underbody and the guide rails of the car wash.
- ▶ Ensure that the clearance width of the car wash, in particular the width of the guide rails, is sufficient.

To avoid damage to your vehicle when using a car wash, ensure the following beforehand:

- Active Distance Assist DISTRONIC and the HOLD function are deactivated.
- the 360° Camera or the rear view camera is switched off.
- the side windows and sliding sunroof are completely closed.
- the blower for the ventilation/heating is switched off.
- the windshield wiper switch is in position **0**.

- in car washes with a conveyor system: neutral **N** is engaged.
- i** If you would like to leave the vehicle while it is being washed, make sure the SmartKey is located in the vehicle. The **P** gear is otherwise automatically engaged.
- i** If, after the car wash, you remove the wax from the windshield and wiper rubbers, this will prevent smearing and reduce wiper noise.

Information on using a power washer

⚠ WARNING Risk of accident when using high-pressure cleaning equipment with round-spray nozzles

The water jet from a round-spray nozzle (dirt grinder) may cause damage to tires and suspension components that is not visible.

Components damaged in this way may fail unexpectedly.

- ▶ Do not use high-pressure cleaning equipment with round-spray nozzles to clean your vehicle.
- ▶ Damaged tires or suspension components must be replaced immediately.

To avoid damage to your vehicle, observe the following when using a power washer:

- Maintain a distance of at least 11.8 in (30 cm) to the vehicle.
- **Vehicles with decorative foil:** parts of your vehicle are covered with a decorative foil. Maintain a distance of at least 27.6 in (70 cm) between the foil-covered parts of the vehicle and the nozzle of the power washer. Move the power washer nozzle around whilst cleaning.

- Observe the information on the correct distance in the equipment manufacturer's operating instructions.
- Do not point the nozzle of the power washer directly at sensitive parts such as tires, slits, electrical components, batteries, light bulbs and ventilation slots.

Washing the vehicle by hand

! **NOTE** Stepping on the wheel arch flares and bumpers may damage them

If you use the wheel arch flares and bumpers as a step, they may be damaged or detach from the vehicle.

- ▶ Only use the two marked steps on the rear bumper as a climbing aid.

Requirements:

- Observe the legal requirements, e.g. in a number of countries, washing by hand is only permitted in specially designated wash bays.
- ▶ Use a mild cleaning agent, e.g. car shampoo.
- ▶ Wash the vehicle with lukewarm water using a soft car sponge. When doing so, do not expose the vehicle to direct sunlight.
- ▶ Carefully hose the vehicle off with water and dry using a chamois. Take care not to point the water jet directly towards the air inlet grille.

Notes on paintwork/matte finish paintwork care

Observe the following information:

	Cleaning and care	Avoiding paintwork damage
Paintwork	<ul style="list-style-type: none">• Insect remains: soak with insect remover and rinse off the treated areas afterwards.• Bird droppings: soak with water and rinse off afterwards.• Tree resin, oils, fuels and greases: remove by rubbing gently with a cloth soaked in petroleum ether or lighter fluid.• Coolant and brake fluid: remove with a damp cloth and clean water.• Tar stains: use tar remover.• Wax: use silicone remover.	<ul style="list-style-type: none">• Do not attach stickers, films or similar.• Remove dirt immediately, where possible.

Cleaning and care		Avoiding paintwork damage
Matte finish	<ul style="list-style-type: none"> • Only use care products approved for Mercedes-Benz. 	<ul style="list-style-type: none"> • Do not polish the vehicle and alloy wheels. • Only use car washes that correspond to the latest engineering standards. • Do not use car wash programs with a final hot wax treatment. • Do not use paint cleaners, buffing or polishing products, gloss preservers, e.g. wax. • Always have paintwork repairs carried out at a qualified specialist workshop.

Notes on cleaning decorative foils

Observe the notes on matte finish care in the chapter "Notes on paintwork/matte finish paint-

work care" (→ page 345). They also apply to matte decorative foils.

Observe the following information:

Cleaning	Avoiding damage to the decorative foil
<ul style="list-style-type: none"> • For cleaning, use plenty of water and a mild cleaning agent without additives or abrasive substances, e.g. a car shampoo approved for Mercedes-Benz. • Remove dirt immediately, where possible, whilst avoiding rubbing too hard. There is otherwise a risk of damaging the decorative foil irreparably. • If there is dirt on the finish or if the decorative foil is dull: use the Paint Cleaner recommended and approved for Mercedes-Benz. • Insect remains: soak with insect remover and rinse off the treated areas afterwards. • Bird droppings: soak with water and rinse off afterwards. • To prevent water stains, dry a foil-wrapped vehicle with a soft, absorbent cloth after every car wash. 	<ul style="list-style-type: none"> • The service life and color of decorative foils are impaired by: <ul style="list-style-type: none"> - sunlight - temperature, e.g. hot air blower - weather conditions - stone chippings and dirt - chemical cleaning agents - oily products • Do not use polish on matte decorative foil. Polishing will have the effect of shining the foil-wrapped surface. • Do not treat matte or structured decorative foils with wax. Permanent stains may occur.

Scratches, corrosive deposits, areas affected by corrosion and damage caused by incorrect care cannot always be completely repaired. In such cases, visit a qualified specialist workshop.

You can obtain more information on care and cleaning products from the manufacturer.

In the case of foil-wrapped surfaces, optical differences may occur between the surfaces that were not protected by a decorative foil after removing a decorative foil.

 Have work or repairs to decorative foils carried out at a qualified specialist workshop, e.g. in an authorized Mercedes-Benz Center.

Notes on care of vehicle parts

⚠ WARNING Risk of entrapment if the windshield wipers are switched on while the windshield is being cleaned

If the windshield wipers are set in motion while you are cleaning the windshield or wiper blades, you can be trapped by the wiper arm.

▶ Always switch off the windshield wipers and the ignition before cleaning the windshield or wiper blades.

⚠ WARNING Risk of burning from the tailpipe or tailpipe trim

The tailpipe and tailpipe trim can become very hot. If you come into contact with these car parts, you could burn yourself.

▶ Always be particularly careful when in the vicinity of the tailpipe and tailpipe trims and supervise children very closely when in this area.

▶ Before any contact, allow the car parts to cool down.

Observe the following information:

	Notes on cleaning and care	Avoiding vehicle damage
Wheels/rims	Use water and acid-free wheel cleaners.	<ul style="list-style-type: none"> • Do not use acidic wheel cleaners to remove brake dust. This could damage wheel bolts and brake components. • To avoid corrosion of the brake discs and brakepads, drive the vehicle for a few minutes after cleaning before parking it. The brake discs and brakepads warm up and dry out.
Windows	Clean the windows on the inside and outside using a damp cloth and cleaning agents recommended by Mercedes-Benz.	Do not use dry cloths or abrasive or solvent-based cleaning agents to clean the inside of windows.

Notes on cleaning and care		Avoiding vehicle damage
Wiper blades	<ul style="list-style-type: none"> • Fold out the wiper blades and clean them using a damp cloth. • Fold wiper arm away from the rear window (→ page 117). 	Do not clean the wiper blades too often.
Exterior lighting	Clean the lenses with a wet sponge and mild cleaning agent, e.g. car shampoo.	Only use cleaning agents or cleaning cloths that are suitable for plastic lenses.
Running board	Do not clean the aluminum inserts on the running board with alkaline or acid-based cleaning agents.	Do not use acidic wheel cleaners to remove brake dust. The aluminum trim inserts could otherwise be damaged.
Sensors	Clean the sensors in the front and rear bumper and in the radiator grill with a soft cloth and car shampoo.	When using a power washer, maintain a minimum distance of 11.8 in (30 cm).
Rear view camera and 360° Camera	<ul style="list-style-type: none"> • Open the camera cover with the multimedia system (→ page 183) . • Use clean water and a soft cloth to clean the camera lens. 	Do not use a power washer.

Notes on cleaning and care		Avoiding vehicle damage
Tailpipes	Clean with cleaning agents recommended by Mercedes-Benz, particularly in the winter and after washing the vehicle.	Do not use acidic cleaning agents.
Trailer hitch	<ul style="list-style-type: none"> • Remove traces of rust on the ball, e.g. with a wire brush. • Remove dirt with a lint-free cloth. • After cleaning, oil or grease the ball head lightly. • Observe the notes on care in the trailer hitch manufacturer's operating instructions. 	Do not clean the ball neck with a power washer or solvent.

Notes on care of the interior

⚠ WARNING Risk of injury from plastic parts breaking off after the use of solvent-based care products

Care and cleaning products containing solvents can cause surfaces in the cockpit to become porous.

When the airbags are deployed, plastic parts may break away.

▶ Do not use any care or cleaning products containing solvents to clean the cockpit.

⚠ WARNING Risk of injury or death from bleached seat belts

Bleaching or dyeing seat belts can severely weaken them.

This can, for example, cause seat belts to tear or fail in an accident.

▶ Never bleach or dye seat belts.

Observe the following information:

Cleaning and care		Avoiding vehicle damage
Seat belts	Clean with lukewarm and soapy water.	<ul style="list-style-type: none"> Do not use chemical cleaning agents. Do not dry seat belts by heating them to over 176 °F (80 °C) or exposing them to direct sunlight.
Display	Clean the surface carefully with a microfiber cloth and a suitable display care product (TFT/LCD).	<ul style="list-style-type: none"> Switch off the display and let it cool down. Do not use any other cleaning products.
Plastic trim	<ul style="list-style-type: none"> Clean with a damp microfiber cloth. For heavy soiling: use care product recommended for Mercedes-Benz. 	<ul style="list-style-type: none"> Do not attach stickers, films or similar materials. Do not allow cosmetics, insect repellent or sun cream to come in contact with the plastic trim.
Real wood/trim inserts	<ul style="list-style-type: none"> Clean with a microfiber cloth. Black piano-lacquer look: clean with a damp cloth and soapy water. For heavy soiling: use care product recommended for Mercedes-Benz. 	Do not use solvent-based cleaning agents, polishes or waxes.
Headliner	Clean with a brush or dry shampoo.	
Carpet	Use carpet and textile cleaning agents recommended for Mercedes-Benz.	

Cleaning and care		Avoiding vehicle damage
Genuine leather seat covers	<ul style="list-style-type: none">• Clean with a damp cloth and then wipe with a dry cloth.• Leather care: use leather care agents that have been recommended for Mercedes-Benz.	<ul style="list-style-type: none">• Do not allow the leather to become too damp.• Do not use a microfiber cloth.
DINAMICA seat covers	Clean with a damp cloth.	Do not use a microfiber cloth.
Imitation leather seat covers	Clean with a damp cloth and 1% soapy water.	Do not use a microfiber cloth.

Emergency

Removing the safety vest

The safety vests are located in the safety vest compartments in the driver's and front passenger door stowage compartments.

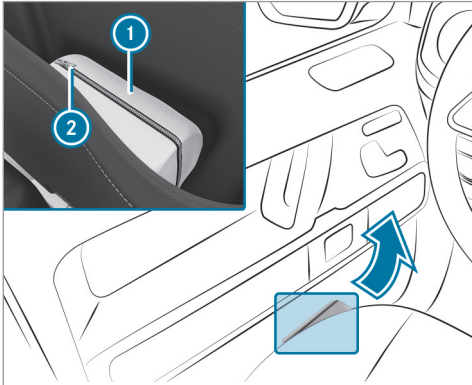

To remove: pull out safety vest bag ① by loop ②.

▶ Open safety vest bag ① and pull out the safety vest.

ⓘ There are also safety vest compartments in the rear door stowage compartments in which safety vests can be stored.

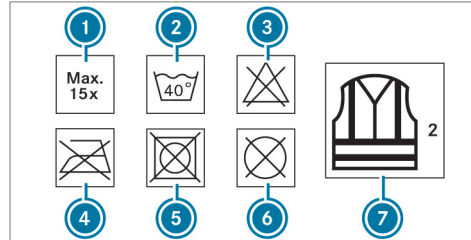

- ① Maximum number of washes
- ② Maximum wash temperature
- ③ Do not bleach
- ④ Do not iron
- ⑤ Do not tumble dry
- ⑥ Do not dry clean
- ⑦ Class 2 safety vest

The requirements defined by the legal standard are only fulfilled if the safety vest is the correct size and is fully closed.

The safety vest must be replaced in the following situations:

- the reflective strips are damaged or dirty
- the maximum permissible number of washes is exceeded
- the fluorescence has faded

Warning triangle

Removing the warning triangle

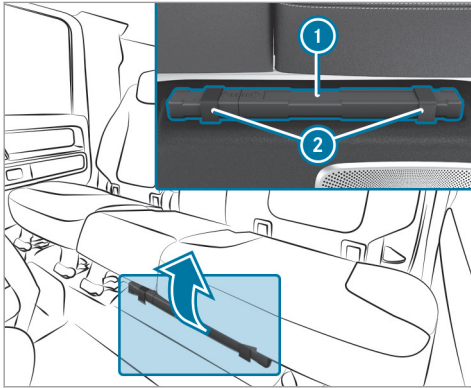

- ▶ Open tabs ②.
- ▶ Remove warning triangle ①.

Setting up the warning triangle

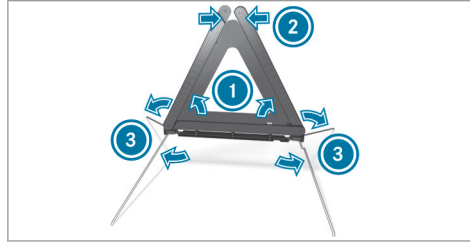

- ▶ Fold side reflectors ① upwards to form a triangle and attach at the top using upper press-stud ②.
- ▶ Fold legs ③ down and out to the side.

First-aid kit (soft-sided) overview

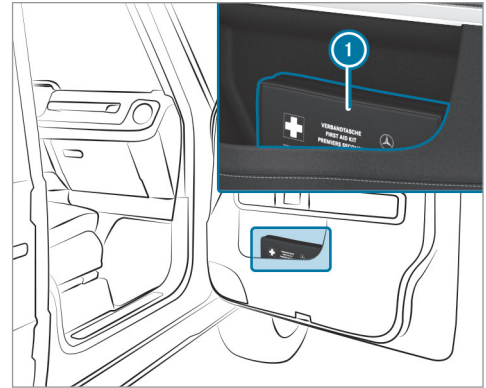

First-aid kit (soft sided) ① in the stowage compartment in the front passenger door.

Flat tire

Notes on flat tires

⚠ WARNING Risk of an accident when driving with a flat tire

A flat tire greatly impairs driving characteristics, as well as steering and braking.

- ▶ Do not drive with a flat tire.
- ▶ Remove the flat tire and install the spare wheel or consult a qualified specialist workshop.

In the event of a flat tire, the following options are available depending on your vehicle's equipment:

- **Vehicles with Mercedes me connect:** you can make a call for breakdown assistance via the overhead control panel in the case of a breakdown (→ page 290).
- **All vehicles:** change the wheel (→ page 393).

i The emergency spare wheel is only available in certain countries.

Spare wheel bracket on the rear-end door

Stainless-steel spare wheel bracket

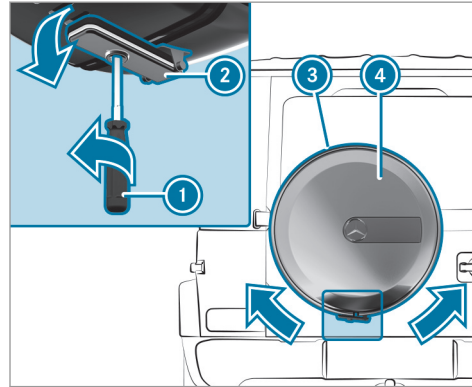

Removing a stainless-steel spare wheel bracket

- ▶ Remove screwdriver **1** from the vehicle tool kit (→ page 392).

- ▶ Open the lock on cover ring **3** with screwdriver **1**.
- ▶ Fold tab **2** down.
- ▶ Pull cover ring **3** apart and remove it.
- ▶ Remove cover panel **4**.

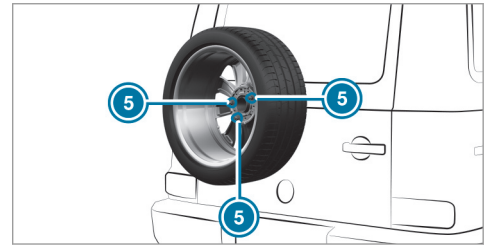

Removing the spare wheel

- ▶ Remove wheel nuts **5**.
- ▶ Remove the spare wheel.

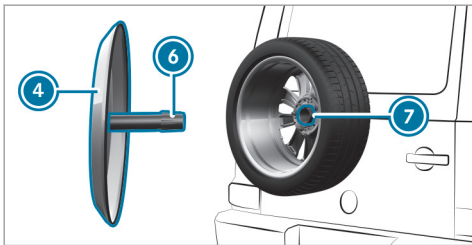

Securing the wheel to the spare wheel bracket

- ▶ Use nuts (5) to secure the defective wheel to the spare wheel bracket. **Specified tightening torque:** 14.75 lb-ft (20 Nm)
 - ▶ Position cover panel (4) again. Make sure that retainer (6) of the cover panel engages in recess (7).
 - ▶ Attach cover ring (3) again and close the lock.
- i** Make sure that the lock does not cover the rear view camera. If necessary, turn cover ring (3) slightly.

Vehicles with an emergency spare wheel:
Observe the notes on the emergency spare wheel.

Spare wheel bracket with protective tire cover

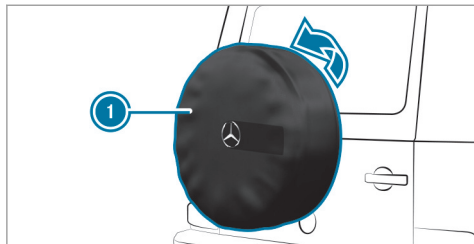

Removing the protective tire cover

- ▶ Pull protective tire cover (1) on the rear side apart and remove it

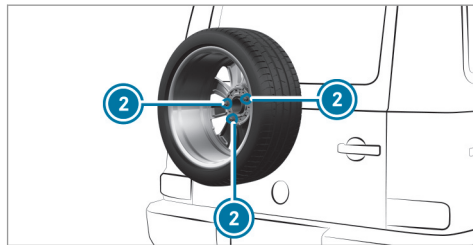

Removing the wheel from the spare wheel bracket and securing a defective wheel

- ▶ Remove wheel nuts (2).
- ▶ Remove the spare wheel.
- ▶ Use nuts (2) to secure the defective wheel to the spare wheel bracket. **Specified tightening torque:** 14.75 lb-ft (20 Nm)

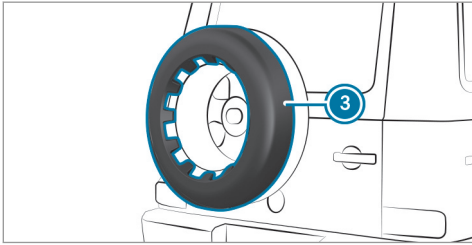

Vehicles with an emergency spare wheel: Remove the half shell

- ▶ Remove half shell ③.
- ▶ Remove wheel nuts ②.
- ▶ Remove the emergency spare wheel.
- ▶ Remove the rear half shell.
- ▶ Use nuts ② to secure the defective wheel to the spare wheel bracket. **Specified tightening torque:** 14.75 lb-ft (20 Nm)
- ▶ Stow the half shells in the cargo compartment.

Vehicles with an emergency spare wheel:
Observe the notes on the emergency spare wheel.

Battery (vehicle)

Notes on the 12 V battery

⚠ WARNING Risk of an accident due to work carried out incorrectly on the battery

Work carried out incorrectly on the battery can, for example, lead to a short circuit. This can lead to function restrictions in safety-relevant systems, for example the lighting system, ABS (anti-lock braking system) or ESP® (Electronic Stability Program). The operating safety of your vehicle may be restricted.

You could lose control of the vehicle in the following situations:

- when braking
- in the event of abrupt steering maneuvers and/or when the vehicle's speed is not adapted to the road conditions

- ▶ In the event of a short circuit or a similar incident, contact a qualified specialist workshop immediately.
- ▶ Do not continue driving.
- ▶ Always have work on the battery carried out at a qualified specialist workshop.

- Further information on ABS (→ page 159)
 - Further information on ESP® (→ page 160)
- For safety reasons, Mercedes-Benz recommends that you only use batteries which have been tested and approved for your vehicle by Mercedes-Benz. These batteries provide increased impact protection to prevent vehicle occupants from suffering acid burns should the battery be damaged in the event of an accident.

⚠ WARNING Risk of explosion due to electrostatic charge

Electrostatic charge can cause sparks which may ignite the highly flammable gas mixture in the battery.

- ▶ To discharge any electrostatic charge that may have built up, touch the metal vehicle body before handling the battery.

The highly flammable gas mixture is created while the battery is charging and during starting assistance.

⚠ WARNING Danger of chemical burns from the battery acid

Battery acid is caustic.

- ▶ Avoid contact with the skin, eyes or clothing.
- ▶ Do not lean over the battery.
- ▶ Do not inhale battery gases.
- ▶ Keep children away from the battery.
- ▶ Immediately rinse battery acid off thoroughly with plenty of clean water and seek medical attention immediately.



ENVIRONMENTAL NOTE Environmental damage caused by improper disposal of batteries



Batteries contain pollutants. It is illegal to dispose of them with the household rubbish.



Dispose of batteries in an environmentally responsible manner. Take discharged batteries to a qualified specialist workshop or to a collection point for used batteries.

If you have to disconnect the 12 V battery, contact a qualified specialist workshop.

Comply with safety notes and take protective measures when handling batteries.



Risk of explosion.



Fire, open flames and smoking are prohibited when handling the battery. Avoid creating sparks.



Electrolyte or battery acid is corrosive. Avoid contact with the skin, eyes or clothing. Wear suitable protective clothing, in particular gloves, an apron and a face mask. Immediately rinse electrolyte or acid splashes off with clean water. Consult a doctor if necessary.



Wear safety glasses.



Keep children away.



Observe this Operator's Manual.

If you do not intend to use the vehicle over an extended period of time:

- activate standby mode, or
- connect the battery to a battery charger approved by Mercedes-Benz, or
- consult a qualified specialist workshop to disconnect the battery

Notes on starting assistance and on charging the 12 V battery

When charging the battery and during starting assistance, always use the jump-start connection point in the engine compartment.

! **NOTE** Damaging the battery through overvoltage

When charging using a battery charger without a maximum charging voltage, the battery or the vehicle electronics may be damaged.

- ▶ Only use battery chargers with a maximum charging voltage of 14.8 V.

! **WARNING** Risk of explosion from hydrogen gas igniting

A battery generates hydrogen gas during the charging process. If there is a short circuit or sparks start to form, there is a danger of the hydrogen gas igniting.

- ▶ Make sure that the positive terminal of the connected battery does not come into contact with vehicle parts.
- ▶ Never place metal objects or tools on a battery.
- ▶ When connecting and disconnecting the battery, you must observe the described order for the battery clamps.
- ▶ When giving starting assistance, always make sure that you only connect battery terminals with identical polarity.
- ▶ During starting assistance, you must observe the described order for con-

necting and disconnecting the jumper cables.

- ▶ Do not connect or disconnect the battery clamps while the engine is running.

! **WARNING** Risk of explosion during charging process and starting assistance

During the charging process and starting assistance, the battery may release an explosive gas mixture.

- ▶ Avoid fire, open flames, creating sparks and smoking.
- ▶ Make sure that there is sufficient ventilation during the charging process and during starting assistance.
- ▶ Do not lean over a battery.

! **WARNING** Risk of explosion from a frozen battery

A discharged battery may freeze at temperatures slightly above or below freezing point.

During starting assistance or battery charging, battery gas may be released.

- ▶ Always thaw a frozen battery out first before charging it or performing starting assistance.

If the indicator/warning lamps in the instrument cluster do not light up at low temperatures, it is very likely that the discharged battery has frozen. In this case you may neither jump-start the vehicle nor charge the battery.

The service life of a battery that has been thawed may be dramatically shortened. The starting characteristics may be impaired, especially at low temperatures.

It is recommended that you have a thawed battery checked at a qualified specialist workshop.

! **NOTE** Damage caused by numerous or extended attempts to start the engine

Numerous or extended attempts to start the engine may damage the catalytic converter due to non-combusted fuel.

- ▶ Avoid numerous and extended attempts to start the engine.

Observe the following points during starting assistance and when charging the battery:

- Only use undamaged jumper cables/charging cables with a sufficient cross-section and insulated terminal clamps.
- Non-insulated parts of the terminal clamps must not come into contact with other metal parts while the jumper cable/charging cable is connected to the battery/jump-start connection point.
- The jumper cable/charging cable must not come into contact with any parts which may move when the engine is running.
- Always make sure that neither you nor the battery is electrostatically charged.
- Keep away from fire and open flames.
- Do not lean over the battery.

Observe the additional following points when charging the battery:

- Only use battery chargers tested and approved for Mercedes-Benz.
- Read the battery charger's operating instructions before charging the battery.

Observe the additional following points during starting assistance:

- Starting assistance may be performed using only batteries with a nominal voltage of 12 V.
- The vehicles must not touch.
- **Gasoline engine:** Only accept starting assistance if the engine and exhaust system are cold.

Starting assistance and charging the 12 V battery

Requirements:

- The vehicle is secured with the electric parking brake.
- The transmission is in position **P**.

- The ignition and all electrical consumers are switched off.
- The hood is open.

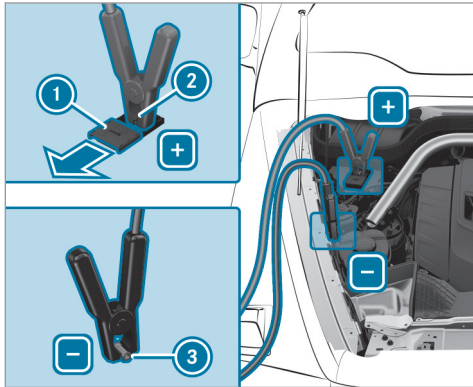

- ▶ Slide cover ① of positive clamp ② on the jump-starting connection point in the direction of the arrow.
- ▶ Connect positive clamp ② on your vehicle to the positive pole of the donor battery using

the jumper cable/charging cable. Always begin with positive clamp ② on your own vehicle first.

- ▶ **During starting assistance:** start the engine of the donor vehicle and run at idle speed.
- ▶ Connect the negative pole of the donor battery and ground point ③ of your own vehicle by using the jumper cable/charging cable. Begin with the donor battery first.
- ▶ **During starting assistance:** start the engine of your own vehicle.
- ▶ **During the charging process:** start the charging process.
- ▶ **During starting assistance:** let the engines run for several minutes.
- ▶ **During starting assistance:** before disconnecting the jumper cable, switch on an electrical consumer in your own vehicle, e.g. the rear window heater or lighting.

When the starting assistance/charging process is complete:

- ▶ First, remove the jumper cable/charging cable from ground point ③ and negative pole of the donor battery, then from positive clamp ② and positive pole of the donor battery. Begin each time with the contacts on your own vehicle first.
- ▶ After removing the jumper cable/charging cable, close cover ① of positive clamp ②.

Further information can be obtained at a qualified specialist workshop.

Replacing the 12 V battery

- ▶ Observe the notes on the 12 V battery (→ page 357).

Mercedes-Benz recommends that you have the 12 V battery replaced at a qualified specialist workshop, e.g. at an authorized Mercedes-Benz Center.

Observe the following notes if you want to replace the battery yourself:

- Always replace a faulty battery with a battery which meets the specific vehicle requirements.

The vehicle is equipped with an AGM technology battery (Absorbent Glass Mat). Full vehicle functionality is only guaranteed with an AGM battery. For safety reasons, Mercedes-Benz recommends that you only use batteries which have been tested and approved for your vehicle by Mercedes-Benz.

- Carry over detachable parts, such as vent hoses, elbow fitting or terminal covers from the battery being replaced.

- Make sure that the vent hose is always connected to the original opening on the side of the battery.

Install any existing or supplied cell caps.

Otherwise, gases or battery acid could escape.

- Make sure that detachable parts are reconnected in the same way.

Tow starting or towing away

Permitted towing methods

Mercedes-Benz recommends transporting your vehicle in the case of a breakdown, rather than towing it away.

For towing, use a tow rope or tow bar with both axles on the ground. Do not use tow bar systems.

! **NOTE** Damage to the vehicle due to towing away incorrectly

▶ Observe the instructions and notes on towing away.

- ⓘ If you tow the vehicle with raised front or rear axles, you must remove the propeller shaft between the transfer case and the rolling axles.

Permitted towing methods



Both axes on the ground

Yes, maximum 31 miles (50 km) at 31 mph (50 km/h)



Front axle raised

Yes



Rear axle raised

Yes

Towing the vehicle with both axes on the ground

- ▶ Observe the notes on the permitted towing methods (→ page 362).
- ▶ Make sure that the battery is connected and charged.

When the battery is discharged:

- the engine cannot be started.
- the electric parking brake cannot be released or applied.
- the transmission cannot be shifted to position **N** or **P**.

- ⓘ If the transmission cannot be shifted to position **N**, transport the vehicle (→ page 365). A towing vehicle with lifting equipment is required for vehicle transportation.

! **NOTE** Damage due to towing away at excessively high speeds or over long distances

The drivetrain could be damaged when towing at excessively high speeds or over long distances.

- ▶ A towing speed of 30 mph (50 km/h) must not be exceeded.

- ▶ A towing distance of 30 miles (50 km) must not be exceeded.

! **WARNING** Risk of accident when towing a vehicle which is too heavy

If the vehicle being tow-started or towed away is heavier than the permissible gross mass of your vehicle, the following situations can occur:

- The towing eye may become detached.
- The vehicle/trailer combination may swerve or even overturn.

- ▶ If another vehicle is tow-started or towed away, its weight must not exceed the permissible gross mass of your own vehicle.

If a vehicle must be tow-started or towed away, its permissible gross mass must not exceed the permissible gross mass of the towing vehicle.

- ▶ Information on the permissible gross mass of the vehicle can be found on the vehicle identification plate (→ page 401).
- ▶ Do not open the driver's door or front passenger door, otherwise the transmission automatically shifts to position **P**.
- ▶ Fasten the tow bar to the towing eyes.

! **NOTE** Damage due to incorrect connection

- ▶ Only connect the tow rope or tow bar to the towing eyes.

- ▶ Deactivate the automatic locking mechanism .

- ▶ Do not activate the HOLD function.
- ▶ Deactivate the tow-away alarm (→ page 77).
- ▶ Deactivate Active Brake Assist (→ page 165).
- ▶ Shift the transmission to position **N**.
- ▶ Release the electric parking brake.

! **WARNING** Risk of accident due to limited safety-related functions during the towing process

Safety-related functions are limited or no longer available in the following situations:

- the ignition is switched off.
- the brake system or power steering system is malfunctioning.
- the energy supply or the on-board electrical system is malfunctioning.

When your vehicle is then towed away, significantly more effort may be required to steer and brake than is normally required.

- ▶ Use a tow bar.

- ▶ Make sure that the steering wheel can move freely, before towing the vehicle away.

! **NOTE** Damage due to excessive tractive power

If you pull away sharply, the tractive power may be too high and the vehicles could be damaged.

- ▶ Pull away slowly and smoothly.

Notes on recovering a vehicle that is stuck

! **NOTE** Damage as a result of recovering a vehicle that is stuck

If the tractive power is too high, the vehicles could be damaged.

- ▶ Pull the vehicle that is stuck out as straight and evenly as possible during recovery.

Observe the following during recovery to avoid damage to your vehicle:

- If the driven wheels get trapped on loose or muddy ground, recover the vehicle with the utmost care,
Especially so if the vehicle is laden.
- Never attempt to recover a vehicle that is stuck with a trailer attached.
- Pull out the vehicle that is stuck backwards, if possible, using the tracks it made before it became stuck.

Towing vehicle away in the event of malfunctions

Notes on towing away in the event of malfunctions

! **NOTE** Damage due to incorrect attachment and use of old nuts

The vehicle and components of the vehicle can be damaged due to incorrect attachment and use of old nuts.

- ▶ If you remove the propeller shaft, place the M10 nuts on the M8 bolts as spacers and secure them with M8 nuts.
- ▶ Always use new self-locking nuts when installing the propeller shafts.

Observe the notes on towing away (→ page 362).

- ① For further information, consult an authorized Mercedes-Benz Center.

Towing away in the event of malfunctions

Towing away in the event of damage to the engine, transmission or electrics

- ▶ Shift the transmission to position **N**.

Towing away in the event of transfer case damage

- ▶ Remove the propeller shafts between the axles and the transfer case.

Towing away in the event of front axle damage

- ▶ Remove the propeller shaft between the rear axle and the transfer case.
- ▶ Tow away the vehicle with a raised front axle.

Towing away in the event of rear axle damage

- ▶ Remove the propeller shaft between the front axle and the transfer case.
- ▶ Tow away the vehicle with a raised rear axle and with wheel rollers under the front axle.

Loading the vehicle for transport

- ▶ Observe the notes on towing away (→ page 362).
- ▶ Connect the tow bar to the towing eye in order to load the vehicle.
- ▶ Shift the transmission to position **N**.

i The automatic transmission may be locked in position **P** in the event of damage to the electrics. To shift to **N**, provide the on-board electrical system with power (→ page 360).

- ▶ Load the vehicle onto the transporter.
- ▶ Shift the transmission to position **P**.
- ▶ Use the electric parking brake to secure the vehicle against rolling away.
- ▶ Only secure the vehicle by the wheels.

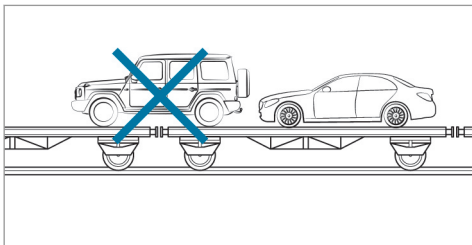

- ▶ Make sure that the front and rear axles come to rest on the same transportation vehicle.

! **NOTE** Damage to the drivetrain due to incorrect positioning

- ▶ Do not position the vehicle above the connection point of the transport vehicle.

Position of towing eyes

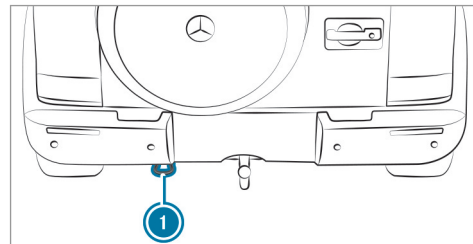
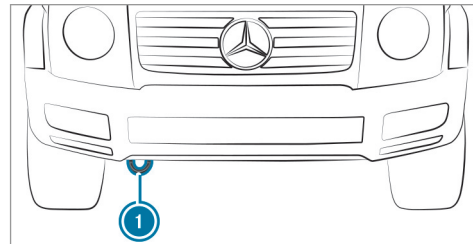

Towing eyes **1** are attached to the front and rear of the vehicle.

Tow-starting the vehicle (emergency engine start)

! **NOTE** Damage to the automatic transmission due to tow starting

The automatic transmission may be damaged in the process of tow starting vehicles with automatic transmission.

- ▶ Vehicles with automatic transmission must not be tow started.

- ▶ Do not tow-start the vehicle.

Electrical fuses

Notes on electrical fuses

! **WARNING** Risk of accident and injury due to overloaded lines

If you manipulate or bridge a faulty fuse or if you replace it with a fuse with a higher amperage, the electric line could be overloaded.

This could result in a fire.

- ▶ Always replace faulty fuses with specified new fuses containing the correct amperage.

! **NOTE** Damage due to incorrect fuses

Electrical components or systems may be damaged by incorrect fuses, or their functionality may be significantly impaired.

- ▶ Only use fuses that have been approved by Mercedes-Benz and which have the correct fuse rating.

Blown fuses must be replaced with fuses of the same rating, which you can recognize by the color and fuse rating. The fuse ratings and further information to be observed are listed in the fuse assignment diagram.

Fuse assignment diagram: on the fuse box in the rear passenger compartment (→ page 368).

! **NOTE** Damage or malfunctions caused by moisture

Moisture may cause damage to the electrical system or cause it to malfunction.

- ▶ When the fuse box is open, make sure that no moisture can enter the fuse box.
- ▶ When closing the fuse box, make sure that the seal of the lid is positioned correctly on the fuse box.

If the newly inserted fuse also blows, have the cause traced and rectified at a qualified specialist workshop.

Ensure the following before replacing a fuse:

- The vehicle is secured against rolling away
- All electrical consumers are switched off
- The ignition is switched off

The electrical fuses are located in various fuse boxes:

- Fuse box in the engine compartment on the left side (→ page 368)

- Fuse box on the right side of the cockpit
(→ page 368)
- Fuse box in the rear passenger compartment
(→ page 368)

Opening and closing the fuse box in the engine compartment

Requirements:

- A dry cloth and a screwdriver are available.

Observe the notes on electrical fuses
(→ page 367).

Opening

⚠ WARNING Risk of injury from using the windshield wipers while the engine hood is open

When the engine hood is open and the windshield wipers are set in motion, you can be trapped by the wiper linkage.

- ▶ Always switch off the windshield wipers and ignition before opening the engine hood.

- ▶ Open the hood.

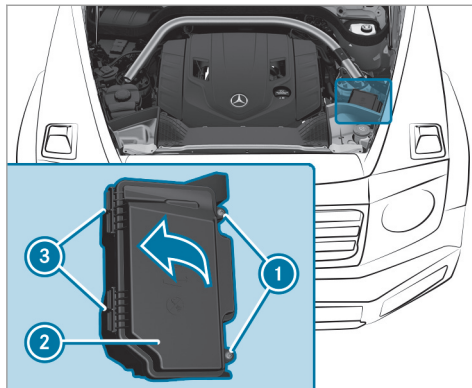

- ▶ Remove any existing moisture from the fuse box using a dry cloth.
- ▶ Loosen screws ①.
- ▶ Fold out cover ② in the direction of the arrow and remove it.

Closing

- ▶ Check whether the seal is positioned correctly in the lid.
- ▶ Place tabs ③ of cover ② in the fuse box.
- ▶ Ensure that cover ② sits on the fuse box.
- ▶ Tighten screws ①.
- ▶ Close the hood.

Opening and closing the fuse box in the cockpit

The fuse box is on the side of the dashboard under a cover.

- ▶ Contact an authorized Mercedes-Benz Center for further information.

Opening and closing the fuse box in the rear passenger compartment

Observe the notes on electrical fuses
(→ page 367).

- ▶ Fold the right-hand seat cushion forward
(→ page 95).

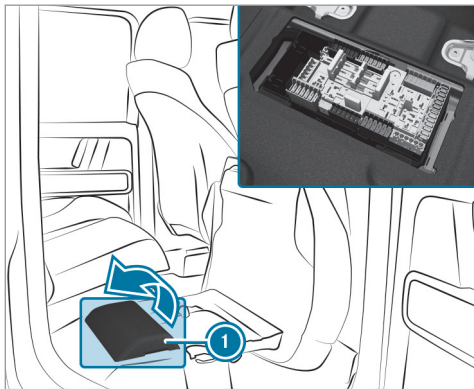

Fold out and remove cover ①.

Notes on noise or unusual handling characteristics

While driving, pay attention to vibrations, noises and unusual handling characteristics, e.g. pulling to one side. This may indicate that the wheels or tires are damaged. If you suspect that a tire is defective, reduce your speed immediately. Stop the vehicle as soon as possible to check the wheels and tires for damage. Hidden tire damage could also be causing the unusual handling characteristics. If you find no signs of damage, have the tires and wheels checked at a qualified specialist workshop.

Notes on regularly inspecting wheels and tires

⚠ WARNING Risk of accident from damaged tires

Damaged tires can cause tire pressure loss. As a result, you could lose control of your vehicle.

▶ Check the tires regularly for signs of damage and replace any damaged tires immediately.

⚠ WARNING Risk of aquaplaning due to insufficient tire tread

Insufficient tire tread will result in reduced tire grip. The tire tread is no longer able to dissipate water.

This means that in heavy rain or slush the risk of hydroplaning is increased, in particular if vehicle speed is not adapted to suit the conditions.

If the tire pressure is too high or too low, tires may exhibit different levels of wear at different locations on the tire contact surface.

▶ Thus, you should regularly check the tread depth and the condition of the tire contact surface across the entire width of all tires.

Minimum tread depth for:

- Summer tires: $\frac{1}{8}$ in (3 mm)
- M+S tires: $\frac{1}{6}$ in (4 mm)

▶ For safety reasons, replace the tires before the legally prescribed limit for the minimum tread depth is reached.

Carry out the following checks on all wheels regularly, at least once a month or as required, e.g. prior to a long journey or driving off-road:

- Check the tire pressure (→ page 371).
- Visually inspect tires and wheels for damage.
- Check the valve caps.

The valves must be protected against moisture and dirt by the valve caps approved especially for your vehicle by Mercedes-Benz.

- Visual check of the tire tread depth and the tire contact surface across the entire width.

The minimum tread depth for summer tires is $\frac{1}{8}$ in (3 mm) and for winter tires $\frac{1}{6}$ in (4 mm).

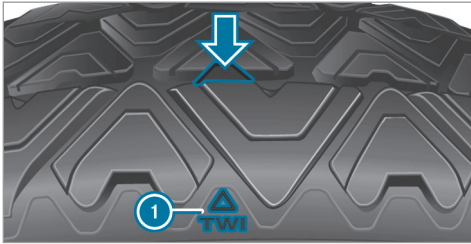

Six marks ① show where the bar indicators (arrow) are integrated into the tire tread. They are visible once a tread depth of approximately $\frac{1}{16}$ in (1.6 mm) has been reached.

Notes on snow chains

! **NOTE** Damage to components of the vehicle body or chassis due to fitted snow chains

If you fit snow chains to the front wheels of 4MATIC vehicles, you may damage components of the vehicle body or chassis.

▶ Only fit snow chains to the rear wheels of 4MATIC vehicles.

The notes on using snow chain-compatible AMG winter tires apply to AMG tires. Snow chains are permitted for use only with these.

- Snow chains are only permissible for certain wheel/tire combinations. You can obtain information about this from an authorized Mercedes-Benz Center.
 - For safety reasons, only use snow chains that have been specifically approved for your vehicle by Mercedes-Benz, or snow chains with the same quality standard.
 - If snow chains are installed, the maximum permissible speed is 30 mph (50 km/h).
 - **Vehicles with Active Parking Assist:** Do not use Active Parking Assist when snow chains are installed.
- ① You can deactivate ESP® to pull away . This allows the wheels to spin, achieving an increased driving force.

Tire pressure

Notes on tire pressure

! **WARNING** Risk of accident due to insufficient or excessive tire pressure

Underinflated or overinflated tires pose the following risks:

- The tires may burst, especially as the load and vehicle speed increase.
- The tires may wear excessively and/or unevenly, which may greatly impair tire traction.
- The driving characteristics, as well as steering and braking, may be greatly impaired.

▶ Comply with the recommended tire pressure and check the tire pressure of all tires including the spare wheel regularly:

- at least once a month
- when the load changes

- before embarking on a longer journey
 - if operating conditions change, e.g. off-road driving
- ▶ Adjust the tire pressure as necessary.

Driving with tire pressure that is too high or too low can:

- Shorten the service life of the tires.
- Cause increased tire damage.
- Adversely affect driving characteristics and thus driving safety, e.g. due to hydroplaning.

⚠ WARNING Risk of an accident due to insufficient tire pressure

Tires with pressure that is too low can overheat and burst as a result.

In addition, they also suffer from excessive and/or irregular wear, which can significantly impair the braking properties and the handling characteristics.

- ▶ Avoid excessively low tire pressures in all the tires, including the spare wheel.

Tire pressure which is too low can cause:

- Tire defects as a result of overheating.
- Impaired handling characteristics.
- Irregular wear.
- Increased fuel consumption.

⚠ WARNING Risk of accident from excessive tire pressure

Tires with excessively high pressure can burst because they are damaged more easily by highway fill, pot holes etc.

In addition, they also suffer from irregular wear, which can significantly impair the braking properties and the handling characteristics.

- ▶ Avoid excessively high tire pressures in all the tires, including the spare wheel.

Excessively high tire pressure can result in:

- Increased braking distance.
- Impaired handling characteristics.
- Irregular wear.

- Impaired driving comfort.
- Susceptibility to damage.

⚠ WARNING Risk of accident caused by repeated drop in tire pressure

If the tire pressure drops repeatedly, the wheel, valve or tire may be damaged.

Insufficient tire pressure can cause the tires to burst.

- ▶ Inspect the tire for signs of foreign objects.
- ▶ Check whether the wheel or valve has a leak.
- ▶ If you are unable to rectify the damage, contact a qualified specialist workshop.

You can find information on tire pressure for the vehicle's factory-installed tires on the following labels:

- Tire and Loading Information placard on the B-pillar of your vehicle (→ page 377).
- Tire pressure table on the inside of the fuel filler flap (→ page 373).

Observe the maximum tire pressure (→ page 383).

Use a suitable pressure gauge to check the tire pressure. The outer appearance of a tire does not permit any reliable conclusion about the tire pressure.

Vehicles with a tire pressure monitoring system: You can also check the tire pressure using the on-board computer.

Only correct tire pressure when the tires are cold. Conditions for cold tires:

- The vehicle has been parked with the tires out of direct sunlight for at least three hours.
- The vehicle has traveled less than 1 mile (1.6 km).

A rise in the tire temperature of 18 °F (10 °C) increases the tire pressure by approx. 10 kPa (0.1 bar/1.5 psi). Take this into account when checking the tire pressure of warm tires.

The tire pressure recommended for increased load/speed in the tire pressure table can affect the ride comfort.

⚠ WARNING Risk of accident due to unsuitable accessories on tire valve

If you mount unsuitable accessories onto tire valves, the tire valves may be overloaded and malfunction, which can cause a loss of tire pressure. Aftermarket tire pressure monitoring systems will cause the tire valve to remain open, depending on the design. This can also result in a loss of tire pressure.

- ▶ Only screw standard valve caps or valve caps specifically approved by Mercedes-Benz for your vehicle onto the tire valve.

Trailer operation notes

Always inflate the rear axle tires to the recommended tire pressure on the tire pressure table for increased load.

Notes on driving on sand

When driving on sand, you can lower the tire pressure (→ page 131).

Tire pressure table

The tire pressure table is on the inside of the fuel filler flap.

- ⓘ The data shown in the images is example data.

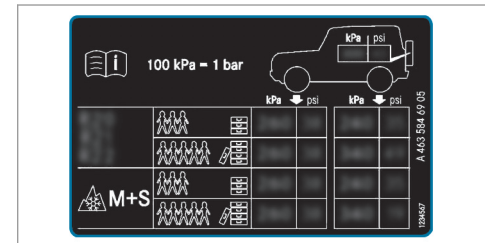

The tire pressure table shows the recommended tire pressures for all tires approved for this vehicle. The recommended tire pressures apply for cold tires under various operating conditions, i.e. loading and/or speed of the vehicle.

If one or more tire sizes precede a tire pressure, the tire pressure information following is only valid for those tire sizes.

The load conditions "partially laden" and "fully laden" are defined in the table for different numbers of passengers and amounts of luggage. The actual number of seats may differ from this.

Some tire pressure tables only show the rim diameter instead of the complete tire size, e.g. **R18**. The rim diameter is part of the tire size and can be found on the tire side wall (→ page 384).

Be sure to also observe the following further related subjects:

- Notes on tire pressure (→ page 371)
- Tire and Loading Information placard (→ page 377)
- Maximum tire pressure (→ page 383)

Checking tire pressures manually

- ▶ Read the tire pressure for the current operating conditions from the Tire and Loading Information placard or the tire pressure table. Observe the notes on tire pressure.
- ▶ Remove the valve cap of the tire to be checked.

- ▶ Press the tire pressure gauge securely onto the valve.
- ▶ Read the tire pressure.
- ▶ If the tire pressure is lower than the recommended value, increase the tire pressure to the recommended value.
- ▶ If the tire pressure is higher than the recommended value, release air. To do so, press down the metal pin in the valve, e.g. using the tip of a pen for example. Then check the tire pressure again using the tire pressure gauge.
- ▶ Screw the valve cap onto the valve.

Further related subjects:

- Notes on tire pressure (→ page 371)
- Tire pressure table (→ page 373)
- Tire and Loading Information placard (→ page 377)

Tire pressure monitoring system

Function of the tire pressure monitoring system

⚠ DANGER Risk of accident due to incorrect tire pressure

Every tire, including the spare (if provided), should be checked when cold at least once a month and inflated to the pressure recommended by the vehicle manufacturer (see Tire and Loading Information placard on the B-pillar on the driver's side or the tire pressure label on the inside of the fuel filler flap of your vehicle). If your vehicle has tires of a different size than the size indicated on the Tire and Loading Information placard or the tire pressure table, you need to determine the proper tire pressure for those tires.

As an added safety feature, your vehicle has been equipped with a tire pressure monitoring system (TPMS) that illuminates a low tire pressure indicator lamp when one or more of your tires are significantly underinflated. Accordingly, if the low tire pressure indicator

lamp lights up, you should stop and check your tires as soon as possible, and inflate them to the proper pressure. Driving on a significantly underinflated tire causes the tire to overheat and can lead to tire failure. Underinflation also increases fuel consumption and reduces tire tread life, and may affect the vehicle's handling and braking ability. Please note that the TPMS is not a substitute for proper tire maintenance, and it is the driver's responsibility to maintain correct tire pressure, even if underinflation has not reached the level to trigger illumination of the TPMS low tire pressure indicator lamp.

Your vehicle has also been equipped with a TPMS malfunction indicator to indicate when the system is not operating properly. The TPMS malfunction indicator is combined with the low tire pressure indicator lamp. When the system detects a malfunction, the indicator lamp will flash for approximately a minute and then remain continuously illuminated. This sequence will continue upon subsequent vehicle start-ups as long as the malfunction exists.

When the malfunction indicator is illuminated, the system may not be able to detect or signal low tire pressure as intended. TPMS malfunctions may occur for a variety of reasons, including the installation of incompatible replacement or alternate tires or wheels on the vehicle that prevent the TPMS from functioning properly.

Always check the TPMS malfunction warning lamp after replacing one or more tires or wheels on your vehicle to ensure that the replacement or alternate tires and wheels allow the TPMS to continue to function properly.

The system checks the tire pressure and the tire temperature of the tires installed on the vehicle by means of a tire pressure sensor.

New tire pressure sensors, e.g. in winter tires, are automatically taught-in during the first journey they are used.

The tire pressure and the tire temperature appear in the multifunction display (→ page 376).

If there is a substantial pressure loss or if the tire temperature is excessive, you will be warned in the following ways:

- via display messages (→ page 442)
- via the  warning lamp in the instrument cluster (→ page 469)

The tire pressure monitoring system is only an aid. It is the driver's responsibility to set the tire pressure to the recommended cold tire pressure suitable for the operating situation. Set the tire pressure for cold tires using a tire pressure gauge. Note that the correct tire pressure for the current operating situation must first be taught-in to the tire pressure monitoring system.

In most cases, the tire pressure monitoring system will automatically update the new reference values after you have changed the tire pressure. You can, however, also update the reference values by restarting the tire pressure monitoring system manually (→ page 376).

System limitations

The system may be impaired or may not function in the following situations:

- If the tire pressure is set incorrectly
- If there is a sudden pressure loss caused, for example, by a foreign object penetrating the tire
- If there is a malfunction caused by another radio signal source

Make sure to observe the following further related subject:

- Notes on tire pressure (→ page 371)

Checking the tire pressure with the tire pressure monitoring system

Requirements:

- The ignition is switched on.

On-board computer:

↪ Service ▶ Tires

One of the following displays appears:

- Current tire pressure and tire temperature of the individual wheels:

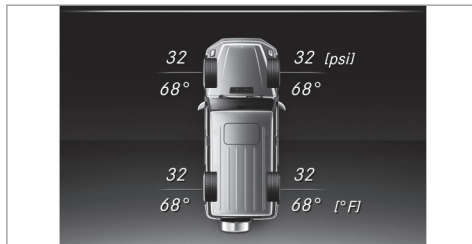

- **Tire pressure will be displayed after driving a few minutes**
- **Tire Pressure Monitor Active:** the teach-in process of the system is not yet complete. The tire pressures are already being monitored.

The teach-in process takes longer if you have engaged the differential locks. Check the tire pressure again at a later date.

- ▶ Compare the tire pressure with the recommended tire pressure for the current operating condition (→ page 373). Observe the notes on tire temperature (→ page 371).

- ⓘ The values displayed in the multifunction display may deviate from those of the tire pressure gauge as they refer to sea level. At high altitudes, the tire pressure value indicated by a pressure gauge are higher than those shown by the on-board computer. In this case, do not reduce the tire pressure.

Make sure to observe the following further related subject:

- Notes on tire pressure (→ page 371)

Restarting the tire pressure monitoring system

Requirements:

- The recommended tire pressure is correctly set for the respective operating status on each of the four wheels (→ page 371).

Restart the tire pressure monitoring system in the following situations:

- The tire pressure has changed.
- The wheels or tires have been changed or newly installed.

On-board computer:

↪ Service ➤ Tires

- ▶ Swipe downwards on Touch Control on the left-hand side of the steering wheel. The **Use Current Pressures as New Reference Values?** message is shown in the multifunction display.
- ▶ To begin restart, press Touch Control on the left-hand side of the steering wheel. The **Tire Press. Monitor Restarted** message is shown in the multifunction display. Current warning messages are deleted and the yellow  warning lamp goes out. After you have been driving for a few minutes, the system checks whether the current tire pressures are within the specified range. The current tire pressures are then accepted as reference values and monitored.

Make sure to observe the following further related subject:

- Notes on tire pressure (→ page 371)

Radio equipment approval of the tire pressure monitoring system

Radio equipment approval numbers

Country	Radio type approval number
Canada	IC: 2546A-AG5SP4
USA	FCC ID: MRXAG5SP4 FCC ID: MRXMFR

Further information on the declaration of conformity for wireless vehicle components (→ page 23).

Loading the vehicle

Notes on Tire and Loading Information placard

⚠ WARNING Risk of accident from overloaded tires

Overloaded tires may overheat and burst as a consequence. Overloaded tires can also

impair the steering and handling characteristics and lead to brake failure.

- ▶ Observe the load-bearing capacity of the tires.
- ▶ The load-bearing capacity must be at least half the gross axle weight rating of the vehicle.
- ▶ Never overload the tires by exceeding the maximum load.

The Tire and Loading Information placard is on the B-pillar on the driver's side of the vehicle.

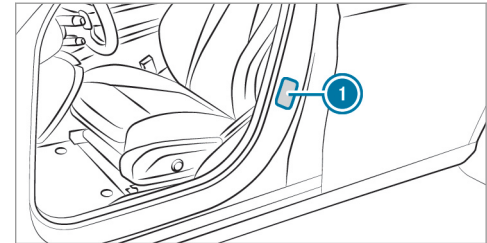

① Tire and Loading Information placard

TIRE AND LOADING INFORMATION		RENSEIGNEMENTS POUR LES PNEUS ET LE CHARGEMENT	
SEATING CAPACITY / NOMBRE DE PLACES		TOTAL / TOTAL	7
FRONT / AVANT		FRONT / AVANT	2
REAR / ARRIÈRE		REAR / ARRIÈRE	2
The combined weight of occupants and cargo should never exceed XXX kg or XXX lbs. / Le poids total des occupants et du chargement ne doit jamais dépasser XXX kg ou XXX lbs.*			
TIRE PNEU	SIZE DIMENSIONS	COLD TIRE PRESSURE / PRESSION DES PNEUS A FROID	SEE OWNER'S MANUAL FOR ADDITIONAL INFORMATION / VOIR LE MANUEL DE L'USAGER POUR PLUS DE RENSEIGNEMENTS
FRONT AVANT	255/40 ZR18 99Y XL	200 KPA, 29 PSI	
REAR ARRIÈRE	285/35 ZR18 101Y XL	200 KPA, 29 PSI	
SPARE DE SECOURS	175/55-18 95P	420 KPA, 60 PSI	

- ① The data shown in the illustration is example data.

The Tire and Loading Information placard shows:

- Maximum number of seats ② according to the maximum number of people permitted to travel in the vehicle.
- Maximum permissible load ③ comprises the gross weight of all vehicle occupants, load and luggage.

- Recommended tire pressures ① for cold tires. The recommended tire pressures are valid for the maximum permissible load and up to the maximum permissible vehicle speed.

Please also note:

- Information on permissible weights and loads on the vehicle identification plate (→ page 401).
- Information on tire pressure in the tire pressure table (→ page 373).

Further related subjects:

- Determining the maximum permissible load (→ page 378)
- Notes on tire pressure (→ page 371).

Determining the maximum permissible load

The following steps have been developed as required of all manufacturers under Title 49, Code of U.S. Federal Regulations, Part 575, pursuant to the "National Traffic and Motor Vehicle Safety Act of 1966".

- ▶ **Step 1:** locate the statement "The combined weight of occupants and load should never exceed XXX kg or XXX lbs." ("The combined weight of occupants and load should never exceed XXX kg or XXX lbs.") on your vehicle's Tire and Loading Information placard.
- ▶ **Step 2:** determine the combined weight of the driver and passengers that will be traveling in your vehicle.
- ▶ **Step 3:** subtract the combined weight of the driver and passengers from XXX kg or XXX lbs.
- ▶ **Step 4:** the resulting figure equals the permissible cargo and luggage load capacity. For example: If "XXX" equals 1400 lbs and there are five occupants in your vehicle with a weight of 150 lbs each, the maximum cargo and luggage load capacity is 650 lbs ($1400 - 750 (5 \times 150) = 650$ lbs).
- ▶ **Step 5:** determine the combined weight of luggage and load that the vehicle will be carrying. For safety reasons, this weight may not safely exceed the available cargo and luggage load capacity calculated in step 4.

Even if you have calculated the total load carefully, you should still make sure that the maximum permissible gross mass and the maximum permissible axle load of your vehicle are not exceeded. Details can be found on the vehicle identification plate.

- ▶ Have your loaded vehicle – including driver, occupants and load – weighed on a vehicle weighbridge.
The measured values may not exceed the maximum permissible values stated on the vehicle identification plate.

Further related subjects:

- Calculation example for determining the maximum load (→ page 379)
- Tire and Loading Information placard (→ page 377)
- Tire pressure table (→ page 373)
- Vehicle identification plate

Calculation example for determining the maximum load

The following table shows examples of how to calculate total and load capacities with varying

seating configurations and different numbers and sizes of occupants. The following examples use a maximum load of 1500 lbs (680 kg). **This is for illustration purposes only.** Make sure you are using the actual load limit for your vehicle stated on your vehicle's Tire and Loading Information placard (→ page 377).

The higher the weight of all the occupants, the smaller the maximum load for luggage.

Step 1

	Example 1	Example 2
Combined maximum weight of occupants and load (data from the Tire and Loading Information placard)	1500 lbs (680 kg)	1500 lbs (680 kg)

Step 2

	Example 1	Example 2
Number of people in the vehicle (driver and occupants)	5	1
Distribution of the occupants	Front: 2 Rear: 3	Front: 1
Weight of occupants	Occupant 1: 150 lbs (68 kg) Occupant 2: 180 lbs (82 kg) Occupant 3: 160 lbs (73 kg) Occupant 4: 140 lbs (63 kg) Occupant 5: 120 lbs (54 kg)	Occupant 1: 200 lbs (91 kg)
Total weight of all occupants	750 lbs (340 kg)	200 lbs (91 kg)

Step 3

	Example 1	Example 2
Permissible load (maximum gross vehicle weight rating from the Tire and Loading Information placard minus the gross weight of all occupants)	1500 lbs (680 kg) - 750 lbs (340 kg) = 750 lbs (340 kg)	1500 lbs (680 kg) - 200 lbs (91 kg) = 1300 lbs (589 kg)

Tire labeling

Overview of tire labeling

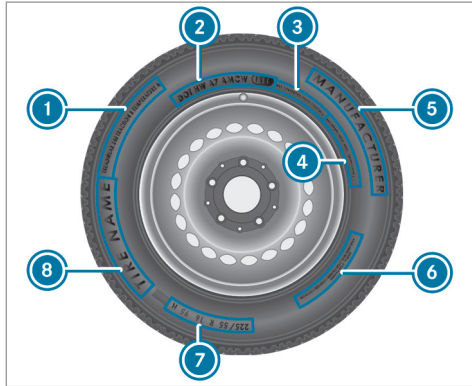

- ① Uniform Tire Quality Grading Standard (→ page 381)
- ② DOT, Tire Identification Number (→ page 382)
- ③ Maximum tire load (→ page 383)
- ④ Maximum tire pressure (→ page 383)

- ⑤ Manufacturer
- ⑥ Characteristics of the tire (→ page 384)
- ⑦ Tire size designation, load-bearing capacity, speed rating and load index (→ page 384)
- ⑧ Tire name
- ① The data shown in the image is example data.

Tire Quality Grading

In accordance with the US Department of Transportation's "Uniform Tire Quality Grading Standards", tire manufacturers are required to grade their tires on the basis of the following three performance factors:

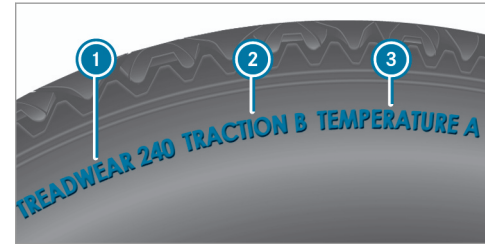

- ① Tread wear grade
- ② Traction grade
- ③ Temperature grade
- ① The data shown in the image is example data.
- ① The classification is not legally stipulated for Canada, but it is generally stated.

Tread wear grade

The tread wear grade is a comparative rating based on the wear rate of the tire when tested under controlled conditions on a specified test track of the US Department of Transportation. For example, a tire graded 150 would wear one

and one-half times as well on the government test track as a tire graded 100.

The relative performance of tires depends upon the actual conditions of their use, however, and may depart significantly from the norm due to variations in driving habits, service practices and differences in road characteristics and climate conditions.

Traction grade

⚠ DANGER Risk of accident due to inadequate traction

The traction grade assigned to this tire is based on straight-ahead braking traction tests, and does not include either acceleration, cornering, hydroplaning or peak traction characteristics.

- ▶ Always adapt your driving style and drive at a speed to suit the prevailing traffic and weather conditions.

! NOTE Damage to the drivetrain from wheelspin

- ▶ Avoid wheelspin.

The traction grades – from highest to lowest – are AA, A, B and C. Those grades represent the tire's ability to stop on wet pavement as measured under controlled conditions on specified government test surfaces made of asphalt and concrete.

Temperature grade

⚠ WARNING Risk of accident from tire overheating and tire failure

The temperature grade for this tire is established for a tire that is properly inflated and not overloaded. Excessive speed, underinflation, or excessive loading, either separately or in combination, can cause excessive heat build-up and possible tire failure.

- ▶ Observe the recommended tire pressures and regularly check the tire pres-

sure of all tires including the spare wheel.

- ▶ Adjust the tire pressure as necessary.

The temperature grades are A (the highest), B and C. They represent the tire's resistance to the generation of heat and its ability to dissipate heat when tested under controlled conditions on a specified indoor laboratory test wheel. Sustained high temperature can cause the material of the tire to degenerate and reduce tire life, and excessive temperature can lead to sudden tire failure. Grade C corresponds to a level of performance which all passenger car tires must meet under the requirements of the US Department of Transportation.

DOT, Tire Identification Number (TIN)

US tire regulations stipulate that every tire manufacturer or retreader must imprint a TIN in or on the side wall of each tire produced.



i The data shown in the image is example data.

The TIN is a unique identification number to identify tires and comprises the following:

- **DOT (Department of Transportation):** tire symbol marks **1** indicating that the tire complies with the requirements of the US Department of Transportation.
- **Manufacturer identification code:** manufacturer identification code **2** contains details of the tire manufacturer. New tires have a code with two symbols. Retreaded tires have a code with four symbols. Further information on retreaded tires (→ page 389).

- **Tire size:** identifier **3** describes the tire size.
- **Tire type code:** tire type code **4** can be used by the manufacturer as a code to describe specific characteristics of the tire.
- **Manufacturing date:** manufacturing date **5** provides information about the age of a tire. The 1st and 2nd positions represent the calendar week and the 3rd and 4th positions state the year of manufacture (e.g. "3208" represents the 32nd week of 2008).

Information on the maximum tire load



i The data shown in the image is example data.

Maximum tire load **1** is the maximum permissible weight for which the tire is approved.

Do not overload the tires by exceeding the specified load limit. The maximum permissible load can be found on the vehicle's Tire and Loading Information placard on the B-pillar on the driver's side (→ page 377).

Specifications for maximum tire pressure



i The data shown in the image is example data.

Never exceed maximum tire pressure ❶ specified for the tire.

Information on tire characteristics



❶ The data shown in the image is example data.

This information describes the type of tire cord and the number of layers in side wall ❶ and under tire tread ❷.

Tire size designation, load-bearing capacity, speed rating and load index

⚠ WARNING Risk of injury through exceeding the specified tire load rating or the permissible speed rating

Exceeding the specified tire load rating or the permissible speed rating may lead to tire damage and to the tires bursting.

- ▶ Therefore, only use tire types and sizes approved for your vehicle model.
- ▶ Observe the tire load rating and speed rating required for your vehicle.

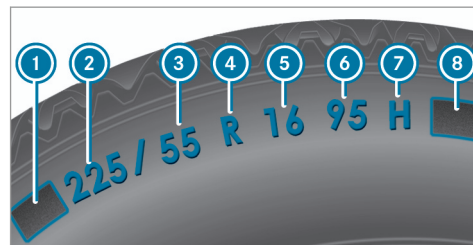

- ❶ Preceding letter
- ❷ Nominal tire width in millimeters
- ❸ Aspect ratio in %
- ❹ Tire code
- ❺ Rim diameter
- ❻ Load-bearing index
- ❼ Speed rating
- ❽ Load index

❶ The data shown in the image is example data.

Information about reading tire data can be obtained from any qualified specialist workshop.

Preceding letter 1:

- Without: passenger vehicle tires according to European manufacturing standards.
- "P": passenger vehicle tires according to US manufacturing standards.
- "LT": light truck tires according to US manufacturing standards.
- "T": compact emergency spare wheels with high tire pressure that are only designed for temporary use in an emergency.

Aspect ratio 3:

Ratio between tire height and tire width in percent (tire height divided by tire width).

Tire code 4 (tire type):

- "R" radial tire
- "D": bias ply tire
- "B": bias belted tires
- "ZR": radial tire with a maximum speed above 149 mph (240 km/h) (optional)

Rim diameter 5:

The diameter of the bead seat (not the diameter of the rim flange). The rim diameter is specified in inches (in).

Load-bearing index 6:

Numerical code that specifies the maximum load-bearing capacity of a tire (e.g. "91" corresponds to 1356 lbs (615 kg)).

The load-bearing capacity of the tire must be at least half the permissible axle load of your vehicle. Do not overload the tires by exceeding the specified load limit.

See also:

- Maximum permissible load on the Tire and Loading Information placard (→ page 377)
- Maximum tire load (→ page 383)
- Load index

Speed rating 7:

Specifies the approved maximum speed of the tire.





- ⓘ An electronic speed limiter prevents your vehicle from exceeding a speed of 130 mph (210 km/h).

Make sure that your tires have the required speed rating. You can obtain information on the required speed rating from an authorized Mercedes-Benz Center.

Summer tires

Index	Speed rating
Q	up to 100 mph (160 km/h)
R	up to 106 mph (170 km/h)
S	up to 112 mph (180 km/h)
T	up to 118 mph (190 km/h)
H	up to 130 mph (210 km/h)
V	up to 149 mph (240 km/h)
W	up to 168 mph (270 km/h)
Y	up to 186 mph (300 km/h)

Index	Speed rating
ZR...Y ¹	up to 186 mph (300 km/h)
ZR...(..Y) ¹	over 186 mph (300 km/h)
ZR ¹	over 149 mph (240 km/h)

- Specifying the speed rating as the "ZR" index in tire code  is optional for tires up to 186 mph (300 km/h).
- If your tire code  includes "ZR" and there is no speed rating , find out what the maximum speed is from the tire manufacturer.
- If load-bearing index  and speed rating  are in brackets, the maximum speed rating of your tire is above 186 mph (300 km/h). To find out the maximum speed, ask the tire manufacturer.

All-weather tires and winter tires

Index	Speed rating
Q M+S ²	up to 100 mph (160 km/h)
T M+S ²	up to 118 mph (190 km/h)
H M+S ²	up to 130 mph (210 km/h)
V M+S ²	up to 149 mph (240 km/h)

Winter tires bear the  snowflake symbol and fulfill the requirements of the Rubber Manufacturers Association (RMA) and the Rubber Association of Canada (RAC) regarding the tire traction on snow.

Load index :

- No specification given: standard load (SL) tire
- "XL" or "Extra Load": extra load tire or reinforced tire
- "Light Load": light load tire

- "C", "D", "E": a load range that depends on the maximum load that the tire can carry at a certain pressure

Definition of terms for tires and loading

Tire structure and characteristics: describes the number of layers or the number of rubber-coated belts in the tire contact surface and the tire wall. These are made of steel, nylon, polyester and other materials.

Bar: metric unit for tire pressure. 14.5038 pounds per square inch (psi) and 100 kilopascal (kPa) is the equivalent of one bar.

DOT (Department of Transportation): DOT-marked tires fulfill the requirements of the US Department of Transportation.

Average weight of the vehicle occupants: the number of vehicle occupants for which the vehicle is designed, multiplied by 150 lb (68 kg).

¹ "ZR" stated in the tire code.

² Or "M+S  " for winter tires

Uniform Tire Quality Grading Standards: a uniform standard to grade the quality of tires with regard to tread quality, tire traction and temperature characteristics. The quality grading assessment is made by the manufacturer following specifications from the U.S. government. The quality grade of a tire is imprinted on the side wall of the tire.

Recommended tire pressure: the recommended tire pressure is the tire pressure specified for the tires mounted to the vehicle at the factory.

The tire and information table contains the recommended tire pressures for cold tires, the maximum permissible load and the maximum permissible vehicle speed.

The tire pressure table contains the recommended tire pressures for cold tires under various operating conditions, i.e. loading and/or speed of the vehicle.

Increased vehicle weight due to optional equipment: the combined weight of all standard and optional equipment available for the vehicle,

regardless of whether it is actually installed on the vehicle or not.

Rim: the part of the wheel on which the tire is installed.

GAWR (Gross Axle Weight Rating): the GAWR is the maximum permissible axle load. The actual load on an axle must never exceed the gross axle weight rating. The gross axle weight rating can be found on the vehicle identification plate on the B-pillar on the driver's side.

Speed rating: the speed rating is part of the tire identification. It specifies the speed range for which a tire is approved.

GVW (Gross Vehicle Weight): the gross vehicle weight comprises the weight of the vehicle including fuel, tools, the spare wheel, accessories installed, occupants, luggage and the trailer drawbar noseweight, if applicable. The gross vehicle weight must not exceed the gross vehicle weight rating GVWR as specified on the vehicle identification plate on the B-pillar on the driver's side.

GVWR (Gross Vehicle Weight Rating): the GVWR is the maximum permitted gross weight

of the fully laden vehicle (weight of the vehicle including all accessories, occupants, fuel, luggage and the trailer drawbar noseweight if applicable). The gross vehicle weight rating is specified on the vehicle identification plate on the B-pillar on the driver's side.

Maximum weight of the laden vehicle: the maximum weight is the sum of the curb weight of the vehicle, the weight of the accessories, the maximum load and the weight of optional equipment installed at the factory.

Kilopascal (kPa): metric unit for tire pressure. 6.9 kPa corresponds to 1 psi. Another unit for tire pressure is bar. 100 kilopascal (kPa) equals 1 bar.

Load index: in addition to the load-bearing index, the load index may also be imprinted on the side wall of the tire. This specifies the load-bearing capacity of the tire more precisely.

Curb weight: the weight of a vehicle with standard equipment including the maximum capacity of fuel, oil and coolant. It also includes the air conditioning system and optional equipment if

these are installed on the vehicle, but does not include passengers or luggage.

Maximum tire load: the maximum tire load is the maximum permissible weight in kilograms or lbs for which a tire is approved.

Maximum permissible tire pressure: maximum permissible tire pressure for one tire.

Maximum load on one tire: maximum load on one tire. This is calculated by dividing the maximum axle load of one axle by two.

PSI (pounds per square inch): standard unit of measurement for tire pressure.

Aspect ratio: ratio between tire height and tire width in percent.

Tire pressure: pressure inside the tire applying an outward force to every square inch of the tire. The tire pressure is specified in pounds per square inch (psi), in kilopascals (kPa) or in bar. The tire pressure should only be corrected when the tires are cold.

Cold tire pressure: the tires are cold when the vehicle has been parked for at least 3 hours

without direct sunlight on the tires or the vehicle has been driven for less than 1 mile (1.6 km).

Tire contact surface: the part of the tire that comes into contact with the road.

Tire bead: the purpose of the tire bead is to ensure that the tire sits securely on the wheel rim. There are several wire cores in the tire bead to prevent the tire from changing length on the wheel rim.

Side wall: the part of the tire between the tread and the tire bead.

Weight of optional equipment: the combined weight of the optional equipment weighing more than the replaced standard parts and more than 5 lbs (2.3 kg). This optional equipment, such as high-performance brakes, level control system, a roof luggage rack or high-performance batteries, is not included in the curb weight and the weight of the accessories.

TIN (Tire Identification Number): a unique identification number which can be used by a tire manufacturer to identify tires, for example, in a product recall, and thus identify the purchasers. The TIN is made up of the manufactur-

er's identity code, tire size, tire type code and the manufacturing date.

Load-bearing index: the load-bearing index is a code that contains the maximum load-bearing capacity of a tire.

Traction: traction is the grip resulting from friction between the tires and the road surface.

Wear indicator: narrow bars (tread wear bars) that are distributed over the tire contact surface. If the tire tread is level with the bars, the wear limit of 1/16 in (1.6 mm) has been reached.

Distribution of vehicle occupants: distribution of vehicle occupants over designated seat positions in a vehicle.

Maximum permissible payload weight: nominal load and luggage load plus 150 lb (68 kg) multiplied by the number of seats in the vehicle.

Changing a wheel

Notes on selecting, installing and replacing tires

Mercedes-AMG vehicles: observe the notes in the Supplement. Otherwise, you may fail to recognize dangers.

You can ask for information regarding permitted wheel/tire combinations at an authorized Mercedes-Benz Center.

⚠ WARNING Risk of accident due to incorrect dimensions of wheels and tires

If wheels and tires of the wrong size are installed, the wheel brakes or wheel suspension components may be damaged.

▶ Always replace wheels and tires with those that fulfill the specifications of the original part.

When replacing wheels, make sure to fit the correct:

- Designation

- Model

When replacing tires, make sure to install the correct:

- Designation
- Manufacturer
- Model

⚠ WARNING Risk of injury through exceeding the specified tire load rating or the permissible speed rating

Exceeding the specified tire load rating or the permissible speed rating may lead to tire damage and to the tires bursting.

- ▶ Therefore, only use tire types and sizes approved for your vehicle model.
- ▶ Observe the tire load rating and speed rating required for your vehicle.

! NOTE Vehicle and tire damage through tire types and sizes that have not been approved

For safety reasons, only use tires, wheels and accessories which have been specially approved by Mercedes-Benz for your vehicle.

These tires are specially adapted to the control systems, such as ABS, ESP® and 4MATIC, and marked as follows:

- MO = Mercedes-Benz Original
- MOE = Mercedes-Benz Original Extended (run-flat tire only for certain wheels)
- MO1 = Mercedes-Benz Original (only certain AMG tires)

Certain characteristics, such as handling, vehicle noise emissions, fuel consumption, etc. may otherwise be adversely affected. Furthermore, other tire sizes could result in the tires rubbing against the body and axle components when loaded. This could result in damage to the tire or the vehicle.

Only use tires, wheels and accessories that have been checked and recommended by Mercedes-Benz.

! **NOTE** Risk to driving safety from retreaded tires

Retreaded tires are neither tested nor recommended by Mercedes-Benz, since previous damage cannot always be detected on retreaded tires.

For this reason driving safety cannot be guaranteed.

▶ Do not use used tires if you have no information about their previous usage.

! **NOTE** Possible damage to wheels or tires when driving over obstacles

Large wheels have a lower tire section width. The lower the tire section width, the greater is the risk of damage to wheels or tires when driving over obstacles.

▶ Avoid obstacles or drive particularly carefully.

! **NOTE** Damage to electronic component parts from the use of tire-mounting tools

Vehicles with a tire pressure monitoring system: Electronic component parts are located in the wheel. Tire-mounting tools should not be used in the area of the valve.

This could otherwise damage the electronic component parts.

▶ Have the tires changed at a qualified specialist workshop only.

! **NOTE** Damage to summer tires at low ambient temperatures

At low ambient temperatures, tears could form when driving with summer tires, causing permanent damage to the tires.

▶ At temperatures below 45 °F (7 °C), use M+S tires .

Accessory parts that are not approved for your vehicle by Mercedes-Benz or are not being used correctly can impair the operating safety.

Before purchasing and using non-approved accessories, visit a qualified specialist workshop and inquire about:

- Suitability
- Legal stipulations
- Factory recommendations

! **WARNING** Risk of accident with high performance tires

The special tire tread in combination with the optimized tire compound means that the risk of skidding or hydroplaning on wet roads is increased.

In addition, the tire grip is greatly reduced at a low outside temperature and tire running temperature.

- ▶ Switch on the ESP® and adapt your driving style accordingly.
- ▶ Use M+S tire at outside temperatures of less than 10 °C (50 °F).

Observe the following when selecting, installing and replacing tires:

- Only use tires and wheels of the same type (summer tires, winter tires, MOExtended tires) and the same make.
- Only install wheels of the same size on one axle (left and right).

It is only permissible to install a different wheel size in the event of a flat tire in order to drive to the specialist workshop.

- Only install tires of the correct size onto the wheels.
- **Vehicles with a tire pressure monitoring system:** All installed wheels must be equipped with functioning sensors for the tire pressure monitoring system.
- At temperatures below 45 °F (7 °C), use winter tires or all-season tire marked M+S for all wheels.

Winter tires bearing the  snowflake symbol in addition to the M+S marking provide the best possible grip in wintry road conditions.

- For M+S tires, only use tires with the same tread.
- Observe the maximum permissible speed for the M+S tires installed.
If this is below the vehicle's maximum speed, this must be indicated by an appropriate label in the driver's field of vision.
- Breaking in new tires at moderate speeds for the first 60 miles (100 km).
- Replace the tires after six years at the latest, regardless of wear.

For more information on wheels and tires, contact a qualified specialist workshop.

Be sure to also observe the following further related subjects:

- Notes on tire pressure (→ page 371)
- Tire and Loading Information placard (→ page 377)
- Tire size designation, load-bearing capacity, speed rating and load index (→ page 384)
- Tire pressure table (→ page 373)

- Notes on the emergency spare wheel (→ page 397)

Notes on rotating wheels

 **WARNING** Risk of injury through different wheel sizes

Interchanging the front and rear wheels if the wheels or tires have different dimensions may severely impair the driving characteristics.

The wheel brakes or wheel suspension components may also be damaged.

 Rotate front and rear wheels only if the wheels and tires are of the same dimensions.

The wear patterns on the front and rear wheels differ:

- Front wheels wear more on the shoulder of the tire
- Rear wheels wear more in the center of the tire

On vehicles that have the same size front and rear wheels, rotate the wheels according to the intervals in the tire manufacturer's warranty book in your vehicle documents. If this is not available, rotate the tires every 3,000 to 6,000 miles (5,000 to 10,000 km), depending on the wear. Ensure that the direction of rotation is maintained.

It is imperative to observe the instructions and safety notes on "Changing a wheel" when doing so Preparing the vehicle for a wheel change(→ page 393).

Notes on storing wheels

When storing wheels, observe the following notes:

- After removing wheels, store them in a cool, dry and preferably dark place.
- Protect the tires from contact with oil, grease or fuel.

Vehicle tool kit overview

The vehicle tool kit contains:

- Vehicle tool bag with:
 - Pump lever for jack
 - Wheel wrench with T-piece
 - Screwdriver (inserted in a pump lever)
- Jack with adapter

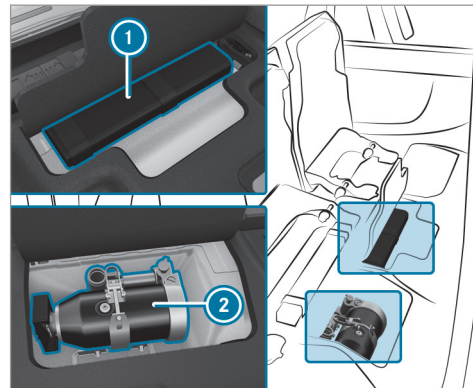

① Vehicle tool bag

② Jack

▶ Fold the rear bench seat forwards (→ page 96).

Preparing the vehicle for a wheel change

Requirements:

- The required tire-change tool is available. If your vehicle is not equipped with the tire-change tool kit, consult a qualified specialist workshop to find out about suitable tools.
 - The vehicle is not on a slope.
 - The vehicle is on solid, non-slippery and level ground.
- ▶ Apply the electric parking brake manually.
 - ▶ Move the front wheels to the straight-ahead position.
 - ▶ Shift the transmission to position **P**.
 - ▶ Switch off the engine.
 - ▶ Make sure that the engine cannot be started.
 - ▶ Place chocks or other suitable items under the front and rear of the wheel that is diagonally opposite the wheel you wish to change.
 - ▶ Remove the hub caps if necessary (→ page 393).
 - ▶ Raise the vehicle (→ page 393).

Removing and installing hub caps

Requirements:

- The vehicle is prepared for a wheel change (→ page 393).

Plastic hub cap

- ▶ **To remove:** turn the center cover of the hub cap counter-clockwise and remove the hub cap.
- ▶ **To install:** make sure that the center cover of the hub cap is turned counter-clockwise.
- ▶ Position the hub cap and turn the center cover clockwise until the hub cap engages physically and audibly.

Raising the vehicle when changing a wheel

Requirements:

- There are no persons in the vehicle.
- The vehicle has been prepared for a wheel change (→ page 393).
- The hub caps have been removed (→ page 393).

Installing the jack

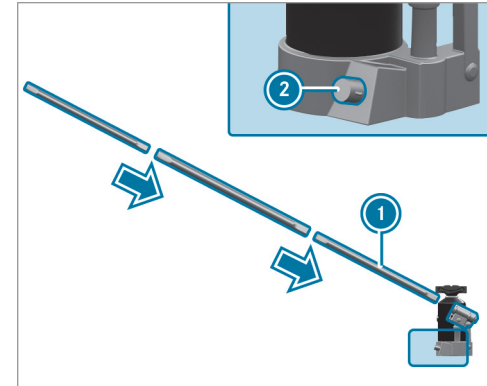

- ▶ Assemble pump lever ①.
- ▶ Place pump lever ① with the recess on lowering screw ② on the jack.
- ▶ Turn pump lever ① clockwise as far as it will go.
- ▶ Lowering screw ② is closed.

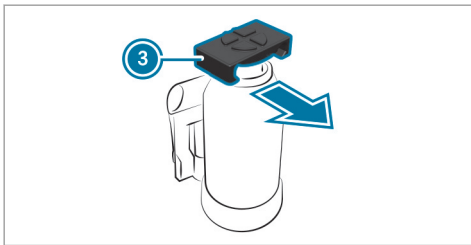

3 Adapter

To raise the vehicle at the front: adapter 3 must be secured on the jack.

To raise the vehicle at the rear: remove adapter 3 from the jack.

Important notes on using the jack:

- Only use the vehicle-specific jack that has been tested and approved by Mercedes-Benz to raise the vehicle.
- The jack is only designed for raising and holding the vehicle for a short time while a wheel is being changed and not for maintenance work under the vehicle.

- The jack must be placed on a firm, flat and non-slip surface. If necessary, use a large, flat, load-bearing, non-slip underlay.
- The jack may only be positioned at the jack support point.

Rules of conduct when the vehicle is raised:

- Never place your hands or feet under the vehicle.
- Never lie under the vehicle.
- Do not start the engine and do not release the electric parking brake.
- Do not open or close any doors or the rear-end door.

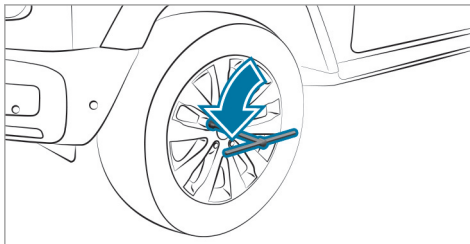

- ▶ Using the lug wrench, loosen the wheel bolts on the wheel you wish to change by about one full turn. Do not unscrew the bolts completely.

⚠ WARNING Risk of injury from incorrect positioning of the jack

If you do not position the jack correctly at the appropriate jacking point of the vehicle, the jack could tip with the vehicle raised.

- ▶ Only position the jack at the appropriate jacking point of the vehicle. The base of the jack must be positioned vertically under the jacking point of the vehicle.

! NOTE Vehicle damage from the jack

If you do not position the jack correctly at the appropriate jack support point of the vehicle, the jack could tip over with the vehicle raised.

- ▶ The jack is designed exclusively for jacking up the vehicle at the jack support points.

Raising the vehicle at the front

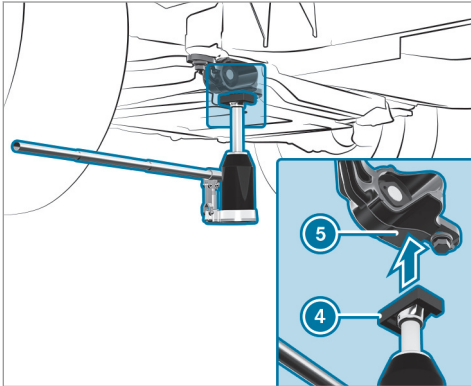

- ▶ Make sure that the adapter is secured on the jack.

- ▶ Position jack ④ on the comfort bushing on transverse link ⑤.
- ▶ Raise the vehicle by pumping until the tire is no more than 1.2 in (3 cm) off the ground.
- ▶ Loosen and remove the wheel (→ page 395).

Raising the vehicle at the rear

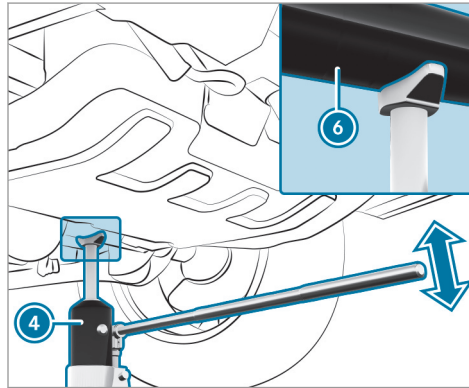

- ▶ Pull out the adapter from the jack.

- ▶ Position jack ④ at the jack support point of axle carrier tube ⑥.
- ▶ Keep pumping until axle carrier tube ⑥ sits securely in the recess of the jack and the base of the jack lies evenly on the ground.
- ▶ Raise the vehicle by pumping until the tire is no more than 1.2 in (3 cm) off the ground.
- ▶ Loosen and remove the wheel (→ page 395).

Removing a wheel

Requirements:

- The vehicle is raised (→ page 393).

When changing a wheel, avoid applying any force to the brake discs, since this could impair the level of comfort when braking.

! **NOTE** Damage to threading from dirt on wheel bolts

- ▶ Do not place wheel bolts in sand or on a dirty surface.

- ▶ Unscrew the wheel bolts.

- ▶ Remove the wheel.
- ▶ Install the new wheel (→ page 396).

Mounting a new wheel

Requirements:

- The wheel is removed (→ page 395).

⚠ WARNING Risk of accident from losing a wheel

Oiled, greased or damaged wheel bolt/wheel nut threads or wheel hub/wheel mounting bolt threads can cause the wheel bolts/wheel nuts to come loose.

As a result, you could lose a wheel while driving.

- ▶ Never oil or grease the threads.
- ▶ In the event of damage to the threads, contact a qualified specialist workshop immediately.
- ▶ Have the damaged wheel bolts or damaged hub threads replaced.
- ▶ Do not continue driving.

- ▶ Observe the information on the choice of tires (→ page 389).

For tires with a specified direction of rotation, an arrow on the side wall of the tire indicates the correct direction of rotation. Observe the direction of rotation when installing.

- ▶ Place the wheel to be installed on the wheel hub and push it on.

⚠ WARNING Risk of injury from tightening wheel bolts and nuts

If you tighten the wheel bolts or wheel nuts when the vehicle is raised, the jack could tip.

- ▶ Only tighten wheel bolts or wheel nuts when the vehicle is on the ground.

- ▶ For safety reasons, only use wheel bolts which have been approved by Mercedes-Benz and for the wheel in question.

! NOTE Damage to paintwork of the wheel rim when screwing on the first wheel bolt

If the wheel has too much play when screwing in the first wheel bolt, the wheel rim paint can be damaged.

- ▶ Press the wheel firmly against the wheel hub when screwing on the first wheel bolt.

- ▶ Tighten the wheel bolts evenly in a diagonal pattern in the order indicated until they are finger-tight.
- ▶ Lower the vehicle (→ page 396).

Lowering the vehicle after a wheel change

Requirements:

- The new wheel has been installed (→ page 396).
- ▶ Place the ratchet onto the hexagon nut of the jack so that the letters "AB" are visible.
- ▶ **To lower the vehicle:** turn the ratchet of the jack counter-clockwise.

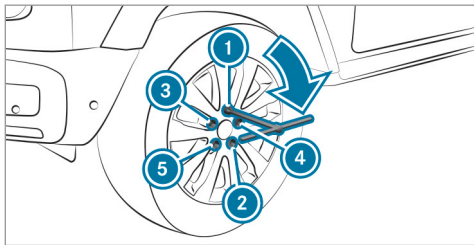

- ▶ Tighten the wheel bolts evenly in a diagonal pattern in the order indicated (① to ⑤).
Specified tightening torque: 111 lb-ft (150 Nm).

⚠ WARNING Risk of injury through incorrect tightening torque

The wheels could come loose if the wheel bolts or wheel nuts are not tightened to the prescribed tightening torque.

- ▶ Make sure the wheel bolts or wheel nuts are tightened to the prescribed tightening torque.

- ▶ If you are not sure, do not move the vehicle. Consult a qualified specialist workshop and have the tightening torque checked immediately.

- ▶ Check the tire pressure of the newly mounted wheel and adjust accordingly.
- ▶ **Vehicles with a tire pressure monitoring system:** Restart the tire pressure monitoring system (→ page 376).

Make sure to observe the following further related subject:

- Notes on tire pressure (→ page 371)

Emergency spare wheel

Notes on the emergency spare wheel

⚠ WARNING Risk of accident caused by incorrect wheel and tire dimensions

The wheel or tire size and the tire type of the emergency spare wheel or spare wheel and the wheel to be replaced may differ. Mount-

ing an emergency spare wheel/spare wheel may severely impair the driving characteristics.

To prevent hazardous situations:

- ▶ Adapt your driving style accordingly and drive carefully.
- ▶ Never mount more than one emergency spare wheel or spare wheel that differs in size.
- ▶ Only use an emergency spare wheel or spare wheel of a different size briefly.
- ▶ Do not switch off ESP®.
- ▶ >Have the emergency spare wheel or spare wheel of a different size replaced at the nearest qualified specialist workshop. The new wheel must have the correct dimensions.

Check the tire pressure of the emergency spare wheel mounted. Correct the pressure as necessary.

The maximum permissible speed with an emergency spare wheel mounted is 50 mph (80 km/h).

Do not mount the emergency spare wheel with snow chains.

Replace the emergency spare wheel after six years at the latest, regardless of wear.

Be sure to also observe the following further related subjects:

- Notes on tire pressure (→ page 371)
- Tire and Loading Information placard (→ page 377)
- Tire pressure table (→ page 373)

Notes on technical data

Mercedes-AMG vehicles: be sure to observe the notes in the Supplement. Otherwise, you may fail to recognize dangers.

The data stated only applies to vehicles with standard equipment. You can obtain further information from an authorized Mercedes-Benz Center.

Vehicle electronics

Two-way radios

Notes on installing two-way radios

⚠ WARNING Risk of accident due to improper work on two-way radios

The electromagnetic radiation from two-way radios can interfere with the on-board electronics if RF transmitters are manipulated or retrofitted incorrectly.

This could jeopardize the operating safety of the vehicle.

▶ You should have all work on electrical and electronic components carried out at a qualified specialist workshop.

⚠ WARNING Risk of accident from incorrect operation of two-way radios

If you operate two-way radios incorrectly in the vehicle, the electromagnetic radiation could interfere with the on-board electronics, e.g.:

- if the two-way radio is not connected to an exterior antenna
- if the exterior antenna is not correctly mounted or is not of low reflection

This could jeopardize the operating safety of the vehicle.

- ▶ Have the low-reflection exterior antenna installed at a qualified specialist workshop.
- ▶ When operating two-way radios in the vehicle, always connect them to the low-reflection exterior antenna.

⚠ NOTE Invalidation of the operating permit due to failure to comply with the instructions for installation and use

The operating permit may be invalidated if the instructions for installation and use of two-way radios are not observed.

- ▶ Only use approved frequency bands.
- ▶ Observe the maximum permissible output power in these frequency bands.
- ▶ Only use approved antenna positions.

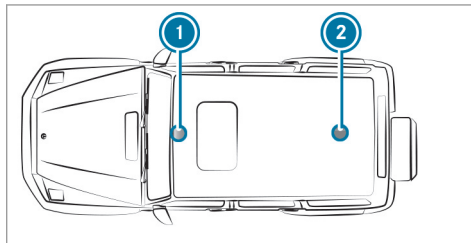

- ① Front roof area
- ② Rear roof area

Use Technical Specification ISO/TS 21609 (Road Vehicles – "EMCs for installation of aftermarket radio frequency transmitting equipment") when retrofitting two-way radios. Comply with the legal requirements for detachable parts.

If your vehicle has installations for two-way radio equipment, use the power supply and antenna connectors provided in the pre-installation. Be sure to observe the manufacturer's supplements when installing.

Two-way radio transmission output

The maximum transmission output (PEAK) at the base of the antenna must not exceed the values in the following table.

Frequency band and maximum transmission output

Frequency band	Maximum transmission output
Short wave 3 - 54 MHz	(100 W)
4 m frequency band 74 - 88 MHz	(30 W)
2 m frequency band 144 - 174 MHz	(50 W)
Trunked radio system/Tetra 380 - 460 MHz	(10 W)
70 cm frequency band 420 - 450 MHz	(35 W)
Two-way radio (2G/3G/4G)	(10 W)

The following devices can be used in the vehicle without restrictions:

- Two-way radios with a maximum transmission output of up to 100 mW
- Two-way radios with transmitter frequencies in the 380 - 410 MHz frequency band and a maximum transmission output of up to 2 W (trunked radio system/Tetra)
- Mobile phones (2G/3G/4G)

There are no restrictions when positioning the antenna on the outside of the vehicle for the following frequency bands:

- Trunked radio system/Tetra
- 70 cm frequency band
- 2G/3G/4G

Vehicle identification plate, VIN and engine number

Vehicle identification plate

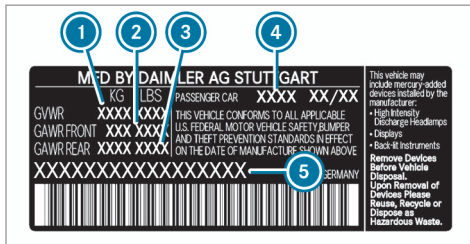
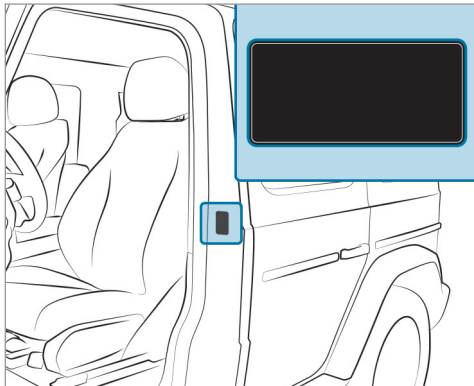

Vehicle identification plate (USA only)

- 1 Maximum gross vehicle weight
- 2 Permissible front axle load
- 3 Permissible rear axle load
- 4 Paint code
- 5 VIN (vehicle identification number)

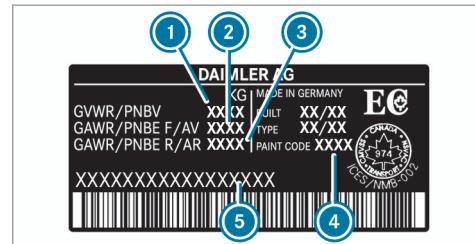

Vehicle identification plate (Canada only)

- 1 Maximum gross vehicle weight
- 2 Permissible front axle load
- 3 Permissible rear axle load
- 4 Paint code
- 5 VIN (vehicle identification number)

The permissible gross vehicle weight is made up of the vehicle weight, all vehicle occupants, the fuel and the load. The maximum gross axle weight rating is the maximum weight that can be carried on one axle (front or rear axle).

Never exceed the permissible gross vehicle weight or the maximum gross axle weight rating for the front or rear axle.

VIN on the chassis

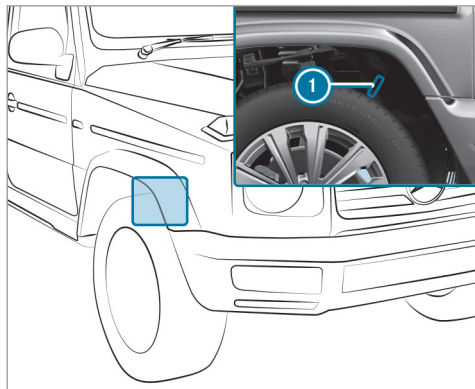

- ① Imprinted VIN (vehicle identification number)

VIN at the lower edge of the windshield

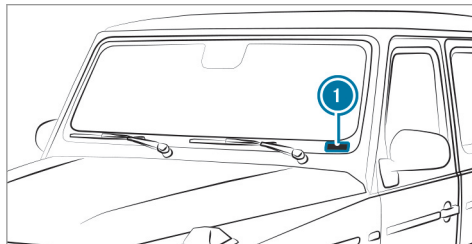

- ① VIN (vehicle identification number) as label

Additional plates

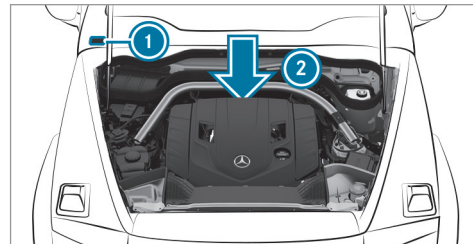

- ① Plate with information about emissions testing, including confirmation of emissions guidelines at the U.S. federal level as well as for California
- ② Engine number stamped into the crankcase

Operating fluids

Notes on operating fluids

Mercedes-AMG vehicles: be sure to observe the information in the Supplement. Otherwise, you may fail to recognize dangers.

⚠ WARNING Risk of injury from operating fluids harmful to your health

Operating fluids may be poisonous and harmful to your health.

- ▶ Observe the text on the original containers when using, storing or disposing of operating fluids.
- ▶ Always store operating fluids sealed in their original containers.
- ▶ Always keep children away from operating fluids.

🌿 ENVIRONMENTAL NOTE Environmental pollution caused by environmentally irresponsible disposal

- ▶ Dispose of operating fluids in an environmentally responsible manner.

Operating fluids include the following:

- Fuels
- Lubricants
- Coolant

- Brake fluid
- Windshield washer fluid
- Climate control system refrigerant

Only use products approved by Mercedes-Benz. Damage caused by the use of products that have not been approved is not covered by the Mercedes-Benz warranty or goodwill gestures.

You can identify operating fluids approved by Mercedes-Benz by the following inscriptions on the container:

- MB-Freigabe (e.g. MB-Freigabe 229.51)
- MB-Approval (e.g. MB-Approval 229.51)

Further information on approved operating fluids is available at the following locations:

- in the Mercedes-Benz Specifications for Operating Fluids by entering the designation
 - at <http://bevo.mercedes-benz.com>
 - in the Mercedes-Benz BeVo App
- at a qualified specialist workshop

⚠ WARNING Risk of fire or explosion from fuel

Fuels are highly flammable.

- ▶ Fire, open flames, smoking and creation of sparks must be avoided.
- ▶ Switch off the ignition and, if available, the stationary heater, before and while refueling the vehicle.

⚠ WARNING Risk of injury from fuels

Fuels are poisonous and hazardous to your health.

- ▶ Do not swallow fuel or let it come into contact with skin, eyes or clothing.
- ▶ Do not inhale fuel vapor.
- ▶ Keep children away from fuel.
- ▶ Keep doors and windows closed during the refueling process.

If you or other people come into contact with fuel, observe the following:

- ▶ Immediately rinse fuel off your skin with soap and water.
- ▶ If fuel comes into contact with your eyes, immediately rinse them thoroughly with clean water. Seek medical attention immediately.
- ▶ If you swallow fuel, seek medical attention immediately. Do not induce vomiting.
- ▶ Change immediately out of clothing that has come into contact with fuel.

Fuel

Notes on fuel grades for vehicles with a gasoline engine

Observe the notes on operating fluids (→ page 402).

! NOTE Damage caused by the wrong fuel

Even small amounts of the wrong fuel could result in damage to the fuel system, the engine and the emission control system.

- ▶ Only refuel with low-sulfur unleaded fuel.

This fuel may contain up to 10% ethanol by volume. Your vehicle is suitable for use with E10 fuel.

Never refuel with one of the following fuels:

- Diesel
- Gasoline with more than 10% ethanol by volume, e.g. E15, E85, E100
- Gasoline with more than 3% methanol by volume, e.g. M15, M30, M85, M100
- Gasoline with additives containing metal

If you have accidentally refueled with the wrong fuel:

- ▶ Do not switch on the ignition.
- ▶ Consult a qualified specialist workshop.

If the available fuel is not sufficiently low in sulfur, this can produce unpleasant odors.

Only refuel with fuel that has at least the octane number specified in the instruction label in the fuel filler flap (→ page 147).

If you want maximum engine output: only refuel with unleaded premium grade gasoline with an octane number of at least 91 AKI/95 RON.

As a temporary measure, if the recommended fuel is not available, you may also refuel with unleaded regular gasoline with at least 87 AKI/91 RON. This may reduce engine output and increase fuel consumption.

Never refuel using gasoline with a lower RON.

! NOTE Premature wear through unleaded regular gasoline

Unleaded regular gasoline can cause the engine to wear more quickly and impair longevity and performance.

If unleaded premium grade gasoline is unavailable and you have to refuel using unleaded regular gasoline:

- ▶ Only fill the fuel tank to half full with unleaded regular gasoline and fill up as soon as possible with unleaded premium grade gasoline.
- ▶ Do not drive at the maximum design speed.
- ▶ Avoid sudden acceleration and engine speeds over 3000 rpm.

Further information on fuel is available at the following locations:

- at a gas station
- at a qualified specialist workshop
- USA only: at <http://www.mbusa.com>

Information on additives in gasoline

Observe the notes on operating fluids (→ page 402).

! **NOTE** Damage from use of unsuitable additives

Even small amounts of the wrong additive may lead to malfunctions occurring.

- ▶ Only add cleaning additives recommended by Mercedes-Benz to the fuel.

Mercedes-Benz recommends that you use fuel brands that have additives.

In some countries, the fuel available may not have sufficient additives. Residue could build up in the fuel injection system as a result. In this case, in consultation with an authorized Mercedes-Benz Center, the fuel may be mixed with the cleaning additive recommended by Mercedes-Benz. Be sure to observe the notes and mixing ratios specified on the container.

Tank content and fuel reserve

Capacity

Model	Total capacity
G 550	26.4 gal (100.0 liters)
Model	Of which reserve
G 550	3.2 gal (12.0 liters)

Engine oil

Notes on engine oil

Observe the notes on operating fluids (→ page 402).



! **NOTE** Engine damage caused by an incorrect oil filter, incorrect oil or additives

- ▶ Do not use engine oils or oil filters other than those which meet the specifications necessary for the prescribed service intervals.

- ▶ Do not alter the engine oil or oil filter in order to achieve longer change intervals than prescribed.
- ▶ Do not use additives.
- ▶ Have the engine oil changed after the prescribed intervals.

Mercedes-Benz recommends that you have the oil change carried out at a qualified specialist workshop.

Further information on engine oil and oil filters is available at the following locations:

- In the Mercedes-Benz Specifications for Operating Fluids by entering the designation:
 - At <http://bevo.mercedes-benz.com>
 - In the Mercedes-Benz BeVo app
- at a qualified specialist workshop

Quality and capacity of engine oil

MB-Freigabe or MB-Approval

Gasoline engine	MB-Freigabe or MB-Approval
G 550	229.52, 229.61

The following values refer to an oil change, including the oil filter.

Replacement amount

Model	Replacement amount
G 550	10.0 US qt (9.5 liters)

Notes on brake fluid

Observe the notes on operating fluids (→ page 402).

⚠ WARNING Risk of an accident due to vapor pockets forming in the brake system

The brake fluid constantly absorbs moisture from the air. This lowers the boiling point of the brake fluid. If the boiling point is too low, vapor pockets may form in the brake system when the brakes are applied hard.

This causes the braking effect to be impaired.

- ▶ Have the brake fluid renewed at the specified intervals.

Have the brake fluid regularly replaced at a qualified specialist workshop. Only use brake fluid approved by Mercedes-Benz according to MB-Freigabe or MB-Approval 331.0. You can obtain further information on brake fluid in the following places:

- in the Mercedes-Benz Specifications for Operating Fluids
 - at <http://bevo.mercedes-benz.com>
 - in the Mercedes-Benz BeVo App

- at a qualified specialist workshop

Coolant

Notes on coolant

Observe the notes on operating fluids (→ page 402).

⚠ WARNING - Risk of fire and injury from antifreeze

If antifreeze comes into contact with hot component parts in the engine compartment, it may ignite.

- ▶ Allow the engine to cool down before adding antifreeze.
- ▶ Make sure that no antifreeze spills out next to the filler opening.
- ▶ Thoroughly clean off any antifreeze from component parts before starting the vehicle.

! NOTE Damage caused by incorrect coolant

- ▶ Only add coolant that has been pre-mixed with the required antifreeze protection.

Information on coolant is available at the following locations:

- In the Mercedes-Benz Specification for Operating Fluids 310.1
 - At <http://bevo.mercedes-benz.com>
 - In the Mercedes-Benz BeVo app
- At a qualified specialist workshop

! NOTE Overheating at high outside temperatures

If an inappropriate coolant is used, the engine cooling system is not sufficiently protected against overheating and corrosion at high outside temperatures.

- ▶ Always use coolant approved by Mercedes-Benz.

- ▶ Observe the instructions in the Mercedes-Benz Specifications for Operating Fluids 310.1.

Have the coolant regularly replaced at a qualified specialist workshop.

The proportion of corrosion inhibitor/antifreeze concentrate in the engine cooling system should be:

- a minimum of 50% (antifreeze protection down to approximately -35 °F (-37 °C))
- a maximum of 55% (antifreeze protection down to -49 °F (-45 °C))

Coolant capacity

Capacity

Model	Capacity
G 550	14.9 US qt (14.1 l)

Notes on windshield washer fluid

Observe the notes on operating fluids (→ page 402).

⚠ WARNING - Risk of fire and injury from windshield washer concentrate

Windshield washer concentrate is highly flammable. It could ignite if it comes into contact with hot engine component parts or the exhaust system.

- ▶ Make sure that no windshield washer concentrate spills out next to the filler opening.

! NOTE Damage to the exterior lighting due to unsuitable windshield washer fluid

Unsuitable windshield washer fluid may damage the plastic surface of the exterior lighting.

- ▶ Only use windshield washer fluid which is also suitable for use on plastic surfaces, e.g. MB SummerFit or MB WinterFit.

! NOTE Blocked spray nozzles caused by mixing windshield washer fluids

- ▶ Do not mix MB SummerFit and MB WinterFit with other windshield washer fluids.

Do not use distilled or de-ionized water as the fill level sensor may be triggered erroneously.

Recommended windshield washer fluid:

- Above freezing point: e.g. MB SummerFit
- Below freezing point: e.g. MB WinterFit

For the correct mixing ratio, refer to the information on the antifreeze container.

Mix the washer fluid with the windshield washer fluid all year round.

Refrigerant

Notes on refrigerants

Observe the notes on operating fluids (→ page 402).

! NOTE Damage due to incorrect refrigerant

If a non-approved refrigerant is used, the climate control system may be damaged.

- ▶ Only use the refrigerant R-134a

! NOTE Damage to the climate control system due to incorrect refrigerant compressor oil

- ▶ Only use refrigerant compressor oil that has been approved by Mercedes-Benz.
- ▶ Do not mix the approved refrigerant compressor oil with a different refrigerant compressor oil.

Work on the climate control system may be carried out only by a qualified specialist workshop. All applicable regulations, as well as SAE standard J639, must be adhered to.

The instruction label on the climate control system for the refrigerant type and the refrigerant compressor oil is located on the radiator cross member in the engine compartment.

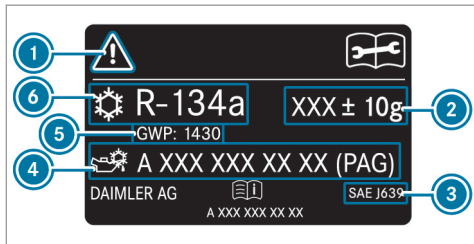

- ① Hazard and service warning symbols
- ② Refrigerant filling capacity
- ③ Applicable standards
- ④ PAG oil part number
- ⑤ GWP (Global Warming Potential) of the refrigerant used
- ⑥ Refrigerant type

Symbols ① warn of the following:

- Possible dangers
- The need to have service work carried out at a qualified specialist workshop only

Refrigerant filling capacity

Filling capacity for refrigerant and PAG oil

Model	Refrigerant
G 550	24.2 ± 0.4 oz (685 ± 10 g)
Model	PAG oil
G 550	2.8 ± 0.4 oz (80 ± 10 g)

Vehicle data

Vehicle dimensions

The heights specified may vary as a result of the following factors:

- Tires
- Load
- Condition of the suspension
- Optional equipment

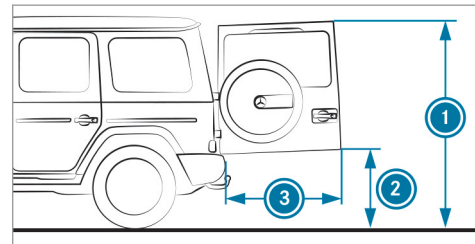

Range of movement

G 550

① Distance to top edge	76.3 in (1937 mm)
② Distance to lower edge	29.3 in (743 mm)
③ Range of movement	43.2 in (1096 mm)

Vehicle dimensions

G 550	
Vehicle length	191.6 in (4866 mm)
Vehicle width including outside mirrors	85.7 in (2177 mm)
Vehicle height	77.5 in (1969 mm)
Wheelbase	113.8 in (2890 mm)
Turning radius	44.6 ft (13.6 m)
Minimum ground clearance	9.5 in (241 mm)

Weights and loads

Note that items of optional equipment increase the curb weight and reduce the payload.

Vehicle data for off-road driving

Fording depth

! **NOTE** Damage caused by water when fording

Water can enter the engine compartment and vehicle interior if:

- you exceed the maximum permissible fording depth when driving through standing water
- a bow wave forms during fording
- water accumulates during fording of flowing water

▶ Do not exceed the maximum permissible fording depth and drive slowly through the water.

The specified value indicates the maximum permissible fording depth for vehicles that are ready to drive. It applies to slow driving through standing water.

Driving through flowing water reduces tire traction. The permissible fording depth is then correspondingly lower.

Observe the notes on off-road driving and fording (→ page 131).



Model

G 550

1 Fording depth

27.6 in (70 cm)

Angle of approach/departure

The specified values are maximum values for vehicles that are ready to drive.

Observe the notes on driving in mountainous terrain (→ page 131).



Model	① Front	② Rear
G 550	30.9°	29.9°

Maximum gradient-climbing capability

The vehicle's gradient climbing ability depends on the weight distribution in the vehicle, the terrain conditions and the road surface conditions. The specified value applies under the following conditions:

- the vehicle is ready to drive

- the **LOW RANGE** off-road gear of the transfer case is engaged
- the road surfaces conditions and thus the traction are good

A gradient climbing ability of 100% corresponds to an incline of 45°.

Observe the notes on driving in mountainous terrain (→ page 131).

Model	Maximum gradient-climbing capability
G 550	100%

Trailer hitch

General notes on the trailer hitch

The installation of a trailer hitch is only permissible if a towing capacity is specified in your vehicle documents.

Further information can be obtained at a qualified specialist workshop.

Permissible towing capacity

The tongue weight is not included in the towing capacity.

Permissible towing capacity, braked (at a minimum start-off gradeability of 8%)

Model	Permissible towing capacity, braked
G 550	7716 lbs (3500 kg)

Permissible towing capacity, braked (at a minimum start-off gradeability of 12%)

Model	Permissible towing capacity, braked
G 550	7716 lbs (3500 kg)

Maximum tongue weight

! **NOTE** Damage caused by the trailer coming loose

If the tongue weight used is too low, the trailer may come loose.

- ▶ The tongue weight must not be below 110.2 lbs (50 kg).
- ▶ Use a tongue weight that is as close as possible to the maximum permissible tongue weight.

Tongue weight

Model	Maximum tongue weight
G 550	496.0 lbs (225 kg)

The actual tongue weight may not be higher than the specified value. The value can be found on the vehicle identification plates of the trailer hitch or of the trailer. The lowest weight applies.

The permissible drawbar tongue weight is the maximum weight with which the drawbar may be

loaded. The permissible drawbar tongue weight is the limit for trailer hitches approved by Mercedes-Benz.

Permissible rear axle load during trailer operation

Axle load

Model	Axle load
G 550	4189 lbs (1900 kg)

Display messages

Introduction

Notes on display messages

Display messages appear on the multifunction display.

Display messages with graphic symbols are simplified in the Operator's Manual and may differ from the symbols on the multifunction display. The multifunction display shows high-priority display messages in red. Certain display messages are accompanied by a warning tone.



Please respond in accordance with the display messages and follow the additional notes in this Operator's Manual.

For some display messages, a symbol is also shown:

-  Further information

-  Hide display message

You can select the desired symbol by swiping left or right on the left-hand Touch Control.

Press the  symbol to show further information on the multifunction display. Press the  symbol to hide the display message.

You can hide low-priority display messages by pressing the  button or the left-hand Touch Control. The display messages are then stored in the message memory.

Rectify the cause of a display message as quickly as possible.

High-priority display messages cannot be hidden. The multifunction display shows these display messages continuously until the cause of the message has been rectified.



Calling up stored display messages

On-board computer:





 Service  1 Message







If there are no display messages, **No Messages** appears on the multifunction display.









 Scroll through the display messages by swiping upwards or downwards on the left-hand Touch Control.

 **To exit the message memory:** press the  button.





Safety systems

Display messages	Possible causes/consequences and ► Solutions
 <p data-bbox="57 350 380 412">Currently Unavailable See Operator's Manual</p>	<p data-bbox="466 236 1377 311">* ESP® is temporarily unavailable. Other driving systems and driving safety systems may also malfunction.</p> <div data-bbox="492 332 1917 567" style="border: 1px solid gray; padding: 5px;"> <p data-bbox="513 342 1222 381">▲ WARNING Risk of skidding if ESP® is malfunctioning</p> <p data-bbox="513 394 1876 464">If ESP® is malfunctioning, ESP® cannot carry out vehicle stabilization. In addition, other driving safety systems are switched off.</p> <ul data-bbox="513 474 1234 557" style="list-style-type: none"> <li data-bbox="513 474 778 508">▶ Drive on carefully. <li data-bbox="513 519 1234 557">▶ Have ESP® checked at a qualified specialist workshop. </div> <ul data-bbox="492 588 1902 695" style="list-style-type: none"> <li data-bbox="492 588 1827 650">▶ Carefully drive on a suitable stretch of road, making slight steering movements at a speed above 19 mph (30 km/h). <li data-bbox="492 660 1902 695">▶ If the display message does not disappear, consult a qualified specialist workshop immediately. Drive carefully.
 <p data-bbox="63 829 196 860">(USA only)</p>	<p data-bbox="466 712 1565 788">* The red  (USA only) or  indicator lamp (Canada only) is lit. You have attempted to release the electric parking brake with the ignition switched off.</p> <ul data-bbox="492 798 813 829" style="list-style-type: none"> <li data-bbox="492 798 813 829">▶ Switch the ignition on.

Display messages	Possible causes/consequences and ► Solutions
 <p>(Canada only)</p> <p>Turn On the Ignition to Release the Parking Brake</p>	
 <p>(USA only)</p>  <p>(Canada only)</p> <p>Parking Brake See Operator's Manual</p>	<p>* The yellow  indicator lamp is lit. The electric parking brake is malfunctioning.</p> <p>To apply:</p> <ul style="list-style-type: none"> ► Switch off the ignition and switch it back on. ► Apply the electric parking brake manually (→ page 156). <p>If it is not possible to apply the electric parking brake:</p> <ul style="list-style-type: none"> ► Visit a qualified specialist workshop. ► Where necessary, also safeguard the parked vehicle against rolling away. <p>The yellow  and the red  (USA only) or  (Canada only) indicator lamps are lit. The electric parking brake is malfunctioning.</p> <p>To release:</p> <ul style="list-style-type: none"> ► Switch off the ignition and switch it back on. ► Release the electric parking brake manually (→ page 156).

Display messages	Possible causes/consequences and ► Solutions
	<p>or</p> <ul style="list-style-type: none">► Release the electric parking brake automatically (→ page 156). <p>If it is still not possible to release the electric parking brake:</p> <ul style="list-style-type: none">► Do not continue driving under any circumstances. Consult a qualified specialist workshop. <p>The yellow  indicator lamp is lit and the red  (USA only) or  (Canada only) indicator lamp is flashing. The electric parking brake is malfunctioning.</p> <p>The electric parking brake could not be applied or released.</p> <ul style="list-style-type: none">► Switch off the ignition and switch it back on. <p>To apply:</p> <ul style="list-style-type: none">► Release and then apply the electric parking brake manually (→ page 156). <p>To release:</p> <ul style="list-style-type: none">► Apply and then release the electric parking brake manually. <p>If the electric parking brake cannot be applied or the red  (USA only) or  (Canada only) indicator lamp continues to flash:</p> <ul style="list-style-type: none">► Do not continue driving under any circumstances. Consult a qualified specialist workshop.► Where necessary, also safeguard the parked vehicle against rolling away. <p>The yellow  indicator lamp is on and the red  indicator lamp (USA only) or the  indicator lamp (Canada only) flashes for approximately ten seconds after the electric parking brake has been applied or released. It then remains lit or goes out. The electric parking brake is malfunctioning.</p>

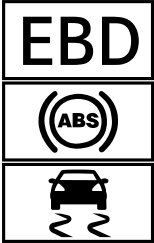
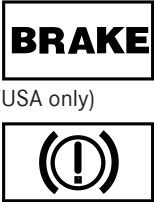

Display messages	Possible causes/consequences and ► Solutions
	<p>If the battery charge level is too low:</p> <ul style="list-style-type: none">► Charge the battery. <p>To apply:</p> <ul style="list-style-type: none">► Switch off the ignition. The electric parking brake is applied automatically. <p>If the electric parking brake should not be applied, e.g. when washing the vehicle in an automatic car wash or when having the vehicle towed, leave the ignition switched on. This does not include having the vehicle towed with the rear axle raised.</p> <p>If the electric parking brake is not applied automatically:</p> <ul style="list-style-type: none">► Switch off the ignition and switch it back on.► Release and then apply the electric parking brake manually (→ page 156). <p>If it is still not possible to apply the electric parking brake:</p> <ul style="list-style-type: none">► Visit a qualified specialist workshop.► Where necessary, also safeguard the parked vehicle against rolling away. <p>To release:</p> <ul style="list-style-type: none">► If the conditions for automatic release are fulfilled and the electric parking brake is not released automatically, release the electric parking brake manually (→ page 156).

Display messages	Possible causes/consequences and ► Solutions
 <p>(USA only)</p>  <p>(Canada only)</p> <p>Please Release Parking Brake</p>	<p>If it is still not possible to release the electric parking brake:</p> <ul style="list-style-type: none">► Do not continue driving under any circumstances. Consult a qualified specialist workshop. <p>* The red  (USA only) or  (Canada only) indicator lamp flashes.</p> <p>The electric parking brake is applied while you are driving:</p> <ul style="list-style-type: none">• A condition for automatic release of the electric parking brake is not fulfilled (→ page 156).• You are performing emergency braking using the electric parking brake (→ page 157). <ul style="list-style-type: none">► Check that the conditions for automatic release of the electric parking brake are fulfilled.► Release the electric parking brake manually.

Display messages	Possible causes/consequences and ► Solutions
 <p data-bbox="118 512 457 572">Inoperative See Operator's Manual</p>	<p data-bbox="527 184 1438 262">* EBD, ABS and ESP® are malfunctioning. Other driving systems and driving safety systems may also malfunction.</p> <div data-bbox="553 283 1982 339" style="background-color: #f0f0f0; padding: 5px;"> <p data-bbox="574 294 1481 329">▲ WARNING Risk of skidding if EBD, ABS and ESP® are malfunctioning</p> </div> <p data-bbox="574 350 1954 412">If EBD, ABS and ESP® are malfunctioning, the wheels can lock when braking and ESP® cannot carry out vehicle stabilization.</p> <p data-bbox="574 427 1954 490">The steering capability and braking characteristics are thus severely impaired. The braking distance in an emergency braking situation can increase. In addition, other driving safety systems are switched off.</p> <ul data-bbox="574 505 1600 578" style="list-style-type: none"> ▶ Drive on carefully. ▶ Have the brake system checked immediately at a qualified specialist workshop. <p data-bbox="553 609 1208 681"> ▶ Drive on carefully. ▶ Visit a qualified specialist workshop immediately. </p>
 <p data-bbox="118 819 253 850">(USA only)</p>	<p data-bbox="527 702 1275 733">* There is insufficient brake fluid in the brake fluid reservoir.</p> <div data-bbox="553 755 1982 811" style="background-color: #f0f0f0; padding: 5px;"> <p data-bbox="574 765 1344 800">▲ WARNING Risk of an accident due to low brake fluid level</p> </div> <p data-bbox="574 816 1815 847">If the brake fluid level is too low, the braking effect and the braking characteristics may be impaired.</p> <ul data-bbox="574 862 1902 925" style="list-style-type: none"> ▶ Pull over and stop the vehicle safely as soon as possible, paying attention to road and traffic conditions. Do not continue driving under any circumstances.

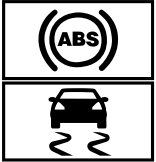
Display messages	Possible causes/consequences and ► Solutions
<p>(Canada only) Check Brake Fluid Level</p>	<div style="border: 1px solid #ccc; padding: 5px; margin-bottom: 10px;"> <ul style="list-style-type: none"> ▶ Consult a qualified specialist workshop. ▶ Do not add brake fluid. </div> <ul style="list-style-type: none"> ▶ Pull over and stop the vehicle safely as soon as possible, paying attention to road and traffic conditions. Do not continue driving under any circumstances. ▶ Do not add brake fluid. ▶ Consult a qualified specialist workshop.
<p>Radar Sensors Dirty See Operator's Manual</p>	<p>* The radar sensor system is malfunctioning. Possible causes are:</p> <ul style="list-style-type: none"> • Dirt on the sensors • Heavy rain or snow • Extended country driving without other traffic, e.g. in the desert <p>Driving systems and driving safety systems may be malfunctioning or temporarily unavailable. Once the cause of the problem is no longer present, driving systems and driving safety systems will be available again.</p> <p>If the display message does not disappear:</p> <ul style="list-style-type: none"> ▶ Pull over and stop the vehicle safely as soon as possible, paying attention to road and traffic conditions. ▶ Clean all sensors (→ page 348). ▶ Restart the engine.

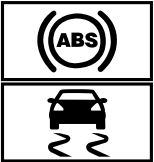



Display messages	Possible causes/consequences and ► Solutions
 <p data-bbox="118 407 445 467">Currently Unavailable See Operator's Manual</p>	<p data-bbox="527 184 1085 218">* ABS and ESP® are temporarily unavailable.</p> <p data-bbox="553 231 1616 265">Other driving systems and driving safety systems may also be temporarily unavailable.</p> <p data-bbox="553 272 1902 334">The brake system continues to operate normally. The braking distance in an emergency braking situation can increase.</p> <div data-bbox="553 360 1984 667" style="background-color: #f0f0f0; padding: 10px;"><p data-bbox="578 370 1416 405">▲ WARNING Risk of skidding if ABS and ESP® are malfunctioning</p><p data-bbox="578 422 1909 487">If ABS and ESP® are malfunctioning, the wheels could lock when braking and ESP® cannot carry out vehicle stabilization.</p><p data-bbox="578 500 1954 565">The steering capability and braking characteristics are thus severely impaired. The braking distance in an emergency braking situation can increase. In addition, other driving safety systems are switched off.</p><ul data-bbox="578 578 1565 653" style="list-style-type: none"><li data-bbox="578 578 844 612">► Drive on carefully.<li data-bbox="578 622 1565 653">► Have ABS and ESP® checked immediately at a qualified specialist workshop.</div> <ul data-bbox="553 686 1968 793" style="list-style-type: none"><li data-bbox="553 686 1892 752">► Carefully drive on a suitable stretch of road, making slight steering movements at a speed above 19 mph (30 km/h).<li data-bbox="553 762 1968 793">► If the display message does not disappear, consult a qualified specialist workshop immediately. Drive carefully.



Display messages	Possible causes/consequences and ► Solutions
 <p data-bbox="57 408 394 464">Inoperative See Operator's Manual</p>	<p data-bbox="466 184 915 218">* ABS and ESP® are malfunctioning.</p> <p data-bbox="492 232 1375 266">Other driving systems and driving safety systems may also malfunction.</p> <p data-bbox="492 273 1841 332">The brake system continues to operate normally. The braking distance in an emergency braking situation can increase.</p> <div data-bbox="492 360 1923 667" style="border: 1px solid gray; padding: 5px;"> <p data-bbox="517 370 1351 405">▲ WARNING Risk of skidding if ABS and ESP® are malfunctioning</p> <p data-bbox="513 425 1845 484">If ABS and ESP® are malfunctioning, the wheels could lock when braking and ESP® cannot carry out vehicle stabilization.</p> <p data-bbox="513 501 1892 560">The steering capability and braking characteristics are thus severely impaired. The braking distance in an emergency braking situation can increase. In addition, other driving safety systems are switched off.</p> <ul style="list-style-type: none"> <li data-bbox="513 578 778 612">► Drive on carefully. <li data-bbox="513 622 1500 656">► Have ABS and ESP® checked immediately at a qualified specialist workshop. </div> <ul style="list-style-type: none"> <li data-bbox="492 687 758 722">► Drive on carefully. <li data-bbox="492 732 1142 766">► Visit a qualified specialist workshop immediately.
 <p data-bbox="57 902 394 958">Inoperative See Operator's Manual</p>	<p data-bbox="466 782 778 816">* ESP® is malfunctioning</p> <p data-bbox="492 829 1375 864">Other driving systems and driving safety systems may also malfunction.</p> <p data-bbox="492 871 1841 930">The brake system continues to operate normally. The braking distance in an emergency braking situation can increase.</p>

Display messages	Possible causes/consequences and ► Solutions
	<p>⚠ WARNING Risk of skidding if ESP® is malfunctioning</p> <p>If ESP® is malfunctioning, ESP® cannot carry out vehicle stabilization. In addition, other driving safety systems are switched off.</p> <ul style="list-style-type: none">▶ Drive on carefully.▶ Have ESP® checked at a qualified specialist workshop. <p>▶ Drive on carefully.</p> <p>▶ Visit a qualified specialist workshop immediately.</p>
 <p>Left Side Curtain Airbag Malfunction Service Required (Example)</p>	<p>* The corresponding window curtain airbag is malfunctioning (→ page 32).</p> <p>⚠ WARNING Risk of injury or fatal injury due to malfunctions in the window airbag</p> <p>If the window airbag is malfunctioning, it might be triggered unintentionally or might not be triggered at all in the event of an accident with high deceleration.</p> <ul style="list-style-type: none">▶ Have the window airbag checked and repaired immediately at a qualified specialist workshop. <p>▶ Visit a qualified specialist workshop immediately.</p>
<p>Front Passenger Airbag Enabled See Operator's Manual</p>	<p>* The front passenger airbag and knee airbags are enabled during the journey:</p> <ul style="list-style-type: none">• even when a child, a small adult or an object weighing less than the system weight threshold is located on the front passenger seat

Display messages	Possible causes/consequences and ► Solutions
	<ul style="list-style-type: none"> • even when the front passenger seat is not occupied <p>The system may detect objects or forces that are adding to the weight applied to the seat.</p> <div style="background-color: #f0f0f0; padding: 5px; border: 1px solid #ccc;"> <p>▲ WARNING Risk of injury or fatal injury when using a child restraint system while the front passenger air bag is enabled</p> <p>If you secure a child in a child restraint system on the front passenger seat and the front passenger air bag is enabled, the front passenger air bag can deploy in the event of an accident.</p> <p>The child could be struck by the air bag.</p> <p>► Ensure, both before and during the journey, that the status of the front passenger air bag is correct.</p> <p>NEVER use a rearward facing child restraint on a seat protected by an ACTIVE FRONT AIR BAG; DEATH or SERIOUS INJURY to the CHILD can occur.</p> </div> <ul style="list-style-type: none"> ► Pull over and stop the vehicle safely as soon as possible, paying attention to road and traffic conditions. ► Check the status of the automatic front passenger airbag shutoff (→ page 43). ► If necessary, consult a qualified specialist workshop immediately.
<p>Front Passenger Airbag Disabled See Operator's Manual</p>	<p>* The front passenger airbag and the knee airbag are deactivated, although an adult or a person with an adult stature is on the front passenger seat. If additional forces are applied to the seat, the weight the system detects may be too low.</p>

Display messages	Possible causes/consequences and ► Solutions
	<p>⚠ WARNING Risk of injury or fatal injury due to a disabled front passenger airbag</p> <p>If the front passenger airbag is disabled, the front passenger airbag will not be deployed in the event of an accident and cannot perform its intended protective function.</p> <p>A person in the front passenger seat could then, for example, come into contact with the vehicle's interior, especially if the person is sitting too close to the cockpit.</p> <p>► Make sure, both before and during the journey, that the status of the front passenger airbag is correct.</p> <ul style="list-style-type: none"> ► Pull over and stop the vehicle safely as soon as possible, paying attention to road and traffic conditions. ► Check the status of the automatic front passenger airbag shutoff (→ page 43). ► If necessary, consult a qualified specialist workshop immediately.
Active Brake Assist Functions Limited See Operator's Manual	<ul style="list-style-type: none"> * Active Brake Assist is malfunctioning. ► Visit a qualified specialist workshop.
PRE-SAFE Inoperative See Operator's Manual	<ul style="list-style-type: none"> * PRE-SAFE® functions are malfunctioning. ► Visit a qualified specialist workshop.
Mercedes me connect Services Limited See Operator's Manual	<ul style="list-style-type: none"> * Service limited. <p>At least one of the main functions of the Mercedes me connect system is malfunctioning.</p> <ul style="list-style-type: none"> ► Observe the notes on the diagnostics connection (→ page 23).



Display messages	Possible causes/consequences and ► Solutions
 <p>Inoperative</p>	<ul style="list-style-type: none"> ► Visit a qualified specialist workshop. <p>* At least one main function of the Mercedes me connect system or of the SOS emergency call system is malfunctioning.</p> <ul style="list-style-type: none"> ► Visit a qualified specialist workshop.
 <p>Front Left Malfunction Service Required (Example)</p>	<p>* The corresponding restraint system is faulty (→ page 32).</p> <div style="background-color: #f0f0f0; padding: 5px; border: 1px solid #ccc;"> <p>▲ WARNING Risk of injury or fatal injury due to a malfunction in the restraint system</p> <p>If the restraint system is malfunctioning, restraint system components may be triggered unintentionally or might not be triggered at all in the event of an accident. This may affect the Emergency Tensioning Device or airbag, for example.</p> <ul style="list-style-type: none"> ► Have the restraint system checked and repaired immediately at a qualified specialist workshop. </div> <p>Detection of a restraint system malfunction:</p> <ul style="list-style-type: none"> • The  restraint system warning lamp does not light up when the ignition is switched on. • The  restraint system warning lamp lights up continuously or repeatedly during a journey. <ul style="list-style-type: none"> ► Visit a qualified specialist workshop immediately.
	<p>* Active Brake Assist is temporarily unavailable. The ambient conditions are outside the system limits .</p>

Display messages	Possible causes/consequences and ► Solutions
<p>Active Brake Assist Functions Currently Limited See Operator's Manual</p>	<ul style="list-style-type: none"> ► Drive on. As soon as the ambient conditions are within the system limits, the system will become available again. ► If the display message does not disappear, stop the vehicle while paying attention to road and traffic conditions and restart the engine.
<div data-bbox="130 342 327 446" data-label="Image"> </div> <p>SRS Malfunction Service Required</p>	<p>* The restraint system is faulty (→ page 32).</p> <div data-bbox="553 391 1984 443" data-label="Text"> <p>▲ WARNING Risk of injury or fatal injury due to a malfunction in the restraint system</p> </div> <p>If the restraint system is malfunctioning, restraint system components may be triggered unintentionally or might not be triggered at all in the event of an accident. This may affect the Emergency Tensioning Device or airbag, for example.</p> <ul style="list-style-type: none"> ► Have the restraint system checked and repaired immediately at a qualified specialist workshop. <p>Detection of a restraint system malfunction:</p> <ul style="list-style-type: none"> • The  restraint system warning lamp does not light up when the ignition is switched on. • The  restraint system warning lamp lights up continuously or repeatedly during a journey. <ul style="list-style-type: none"> ► Visit a qualified specialist workshop immediately.
<p>Check Brake Pads See Operator's Manual</p>	<p>* The brake pads have reached the wear limit.</p> <div data-bbox="553 847 1984 899" data-label="Text"> <p>▲ WARNING Risk of accident due to restricted braking power</p> </div> <p>When the brake pads have reached their wear limit, the braking power may be restricted.</p>



Display messages	Possible causes/consequences and ► Solutions
	<ul style="list-style-type: none"> ▶ Drive on carefully. ▶ Have the brake system checked immediately at a qualified specialist workshop. <p>▶ Visit a qualified specialist workshop.</p>

Driving systems

Display messages	Possible causes/consequences and ► Solutions
 <p>Off</p>	<p>* The HOLD function is deactivated because the vehicle is skidding or a condition for activation is not met.</p> <p>▶ Reactivate the HOLD function later or check the activation conditions for the HOLD function (→ page 171).</p>
<p>Traffic Sign Assist Camera View Restricted See Operator's Manual</p>	<p>* The camera view is restricted. Possible causes are:</p> <ul style="list-style-type: none"> • Dirt on the windshield in the camera's field of vision • Heavy rain, snow or fog <p>Driving systems and driving safety systems may be malfunctioning or temporarily unavailable. Once the cause of the problem is no longer present, driving systems and driving safety systems will be available again.</p> <p>If the display message does not disappear:</p>

Display messages	Possible causes/consequences and ► Solutions
	<ul style="list-style-type: none"> ► Pull over and stop the vehicle safely as soon as possible, paying attention to road and traffic conditions. ► Clean the windshield.
Blind Spot Assist Inoperative	<ul style="list-style-type: none"> * Blind Spot Assist is malfunctioning. ► Visit a qualified specialist workshop.
Active Lane Keeping Assist Inoperative	<ul style="list-style-type: none"> * Active Lane Keeping Assist is malfunctioning. ► Consult a qualified specialist workshop.
 <p data-bbox="118 557 466 619">Malfunction Drive at Max. 50 mph</p>	<ul style="list-style-type: none"> * The adjustable damping is malfunctioning. The vehicle's handling characteristics may be affected. ► Do not drive at speeds greater than 50 mph (80 km/h). ► Visit a qualified specialist workshop.
Blind Spot Assist Not Available When Towing a Trailer See Operator's Manual	<ul style="list-style-type: none"> * When you establish the electrical connection to the trailer, Blind Spot Assist is unavailable. ► Press the left-hand Touch Control and acknowledge the display message.
 <p data-bbox="118 881 466 940">ATTENTION ASSIST: Take a Break!</p>	<ul style="list-style-type: none"> * ATTENTION ASSIST has detected fatigue or an increasing lack of concentration on the part of the driver (→ page 190). ► If necessary, take a break.



Display messages	Possible causes/consequences and ► Solutions
<p>Traffic Sign Assist Inoperative</p>	<ul style="list-style-type: none"> * Traffic Sign Assist is malfunctioning. <ul style="list-style-type: none"> ► Visit a qualified specialist workshop.
<p>Active Lane Keeping Assist Currently Unavailable See Operator's Manual</p>	<ul style="list-style-type: none"> * Active Lane Keeping Assist is temporarily unavailable. The ambient conditions are outside the system limits (→ page 195). <ul style="list-style-type: none"> ► Drive on. As soon as the ambient conditions are within the system limits, the system will become available again. ► Pull over and stop the vehicle safely as soon as possible, paying attention to road and traffic conditions. ► Clean the windshield.
<div data-bbox="69 534 263 638" data-label="Image"> </div> <p>ATTENTION ASSIST Inoperative</p>	<ul style="list-style-type: none"> * ATTENTION ASSIST is malfunctioning. <ul style="list-style-type: none"> ► Consult a qualified specialist workshop.
<p>Traffic Sign Assist Currently Unavailable See Operator's Manual</p>	<ul style="list-style-type: none"> * Traffic Sign Assist is temporarily unavailable. <ul style="list-style-type: none"> ► Drive on. Once the cause of the problem is no longer present, the system will be available again.
<div data-bbox="69 855 263 959" data-label="Image"> </div>	<ul style="list-style-type: none"> * Active Distance Assist DISTRONIC was deactivated. If a warning tone also sounds, the Active Distance Assist DISTRONIC has deactivated automatically (→ page 169).



Display messages	Possible causes/consequences and ► Solutions
Off	
 <p>--- mph</p>	<ul style="list-style-type: none"> * Active Distance Assist DISTRONIC cannot be activated as not all activation conditions have been fulfilled. <ul style="list-style-type: none"> ► Comply with the activation conditions of Active Distance Assist DISTRONIC (→ page 169).
 <p>Suspended</p>	<ul style="list-style-type: none"> * If you activate the accelerator pedal beyond the Active Distance Assist DISTRONIC setting, the system will be put into passive mode (→ page 170).
Active Distance Assist Currently Unavailable See Operator's Manual	<ul style="list-style-type: none"> * Active Distance Assist DISTRONIC is temporarily unavailable. The ambient conditions are outside the system limits (→ page 167). <ul style="list-style-type: none"> ► Drive on. As soon as the ambient conditions are within the system limits, the system will become available again.
Active Distance Assist Inoperative	<ul style="list-style-type: none"> * Active Distance Assist DISTRONIC is malfunctioning. Other driving systems and driving safety systems may also malfunction. <ul style="list-style-type: none"> ► Visit a qualified specialist workshop.
Active Distance Assist Now Available	<ul style="list-style-type: none"> * Active Distance Assist DISTRONIC is operational again and can be activated (→ page 169).



Display messages	Possible causes/consequences and ► Solutions
 <p>--- mph</p>	<ul style="list-style-type: none"> * Cruise control cannot be activated as not all activation conditions are fulfilled. <ul style="list-style-type: none"> ► Observe the activation conditions for cruise control (→ page 166).
Cruise Control Off	<ul style="list-style-type: none"> * Cruise control has been deactivated. If there is an additional warning tone, cruise control has been deactivated automatically (→ page 165).
Cruise Control Inoperative	<ul style="list-style-type: none"> * Cruise control is malfunctioning. <ul style="list-style-type: none"> ► Visit a qualified specialist workshop.
Blind Spot Assist Currently Unavailable See Operator's Manual	<ul style="list-style-type: none"> * Blind Spot Assist is temporarily unavailable. The system limits have been reached (→ page 193). <ul style="list-style-type: none"> ► Drive on. Once the cause of the problem is no longer present, the system will be available again. or ► If the display message does not disappear, stop the vehicle while paying attention to road and traffic conditions and restart the engine. ► If necessary, clean the rear bumper. If the bumper is extremely dirty, the sensors in the bumper may be malfunctioning.
	<ul style="list-style-type: none"> * The camera view is restricted.

Display messages	Possible causes/consequences and ► Solutions
<p>Active Lane Keeping Assist Camera View Restricted See Operator's Manual</p>	<p>Possible causes are:</p> <ul style="list-style-type: none"> • dirt on the windshield in the camera's field of vision • heavy rain, snow or fog <p>Driving systems and driving safety systems may be malfunctioning or temporarily unavailable. Once the cause of the problem is no longer present, driving systems and driving safety systems will be available again.</p> <p>If the display message does not disappear:</p> <ul style="list-style-type: none"> ► Pull over and stop the vehicle safely as soon as possible, paying attention to road and traffic conditions. ► Clean the windshield.
<p>Active Parking Assist and PARKTRONIC Inoperative See Operator's Manual</p>	<p>* Active Parking Assist and Parking Assist PARKTRONIC are malfunctioning.</p> <ul style="list-style-type: none"> ► Stop the vehicle, paying attention to road and traffic conditions, and restart the engine. ► If the display message continues to be displayed, consult a qualified specialist workshop.

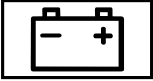
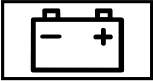
Engine



Display messages	Possible causes/consequences and ▶ Solutions
 <p>See Operator's Manual</p>	<p>* The battery is not being charged.</p> <div data-bbox="492 288 1917 436" style="border: 1px solid gray; padding: 5px;"> <p>! NOTE Possible engine damage if you continue driving</p> <ul style="list-style-type: none"> ▶ Do not continue driving under any circumstances. ▶ Consult a qualified specialist workshop. </div> <ul style="list-style-type: none"> ▶ Pull over and stop the vehicle safely and switch off the engine, paying attention to road and traffic conditions. ▶ Consult a qualified specialist workshop.
 <p>Stop Vehicle Leave Engine Running</p>	<p>* The battery charge level is too low.</p> <ul style="list-style-type: none"> ▶ Pull over and stop the vehicle safely as soon as possible, paying attention to road and traffic conditions. Do not continue driving under any circumstances. ▶ Leave the engine running. ▶ Wait until the display message disappears before pulling away.
<p>Check Coolant Level See Operator's Manual</p>	<p>* The coolant level is too low.</p> <div data-bbox="492 816 1917 923" style="border: 1px solid gray; padding: 5px;"> <p>! NOTE Engine damage due to insufficient coolant</p> <ul style="list-style-type: none"> ▶ Avoid long journeys with insufficient coolant. </div> <ul style="list-style-type: none"> ▶ Add coolant (→ page 341).



Display messages	Possible causes/consequences and ► Solutions
 <p data-bbox="118 301 425 360">12 V Battery See Operator's Manual</p>	<ul style="list-style-type: none"> * The engine is off and the battery charge level is too low. <ul style="list-style-type: none"> ► Switch off electrical consumers that are not required. ► Leave the engine running for a few minutes, or drive for a longer distance. The battery will charge.
 <p data-bbox="118 498 425 557">Stop Vehicle See Operator's Manual</p>	<ul style="list-style-type: none"> * The battery is no longer being charged and the battery charge level is too low. <div style="border: 1px solid black; padding: 5px; margin: 10px 0;"> <p>! NOTE Possible engine damage if you continue driving</p> <ul style="list-style-type: none"> ► Do not continue driving under any circumstances. ► Consult a qualified specialist workshop. </div> <ul style="list-style-type: none"> ► Pull over and stop the vehicle safely as soon as possible, paying attention to road and traffic conditions. Do not continue driving under any circumstances. ► Switch off the engine. ► Consult a qualified specialist workshop.
	<ul style="list-style-type: none"> * The fan motor is defective. <ul style="list-style-type: none"> ► Avoiding high loads on the engine, drive to the nearest qualified specialist workshop. In doing so, ensure that the coolant temperature display remains below the red marking.

Display messages	Possible causes/consequences and ► Solutions
 <p data-bbox="57 301 400 363">Coolant Too Hot Stop Vehicle Turn Engine Off</p>	<p data-bbox="466 184 768 213">* The coolant is too hot.</p> <ul style="list-style-type: none"> <li data-bbox="486 228 1888 259">► Pull over and stop the vehicle safely and switch off the engine, paying attention to road and traffic conditions. <div data-bbox="492 291 1917 339" style="background-color: #e0e0e0; padding: 5px;"> <p data-bbox="513 301 1205 332">▲ WARNING Danger of burns when opening the hood</p> </div> <p data-bbox="513 350 1847 415">If you open the hood when the engine has overheated or during a fire in the engine compartment, you could come into contact with hot gases or other escaping operating fluids.</p> <ul style="list-style-type: none"> <li data-bbox="513 425 1255 455">► Before opening the hood, allow the engine to cool down. <li data-bbox="513 467 1733 497">► In the event of a fire in the engine compartment, keep the hood closed and call the fire service. <ul style="list-style-type: none"> <li data-bbox="486 534 1013 564">► Wait until the engine has cooled down. <li data-bbox="486 576 1304 606">► Make sure that the air supply to the radiator is not obstructed. <li data-bbox="486 617 1882 682">► Avoiding high loads on the engine, drive to the nearest qualified specialist workshop. In doing so, ensure that the coolant temperature display remains below the red marking.
 <p data-bbox="57 819 247 850">Gas Cap Loose</p>	<p data-bbox="466 702 1851 767">* There has been pressure loss in the fuel system. The fuel filler cap is not closed correctly or the fuel system is leaking.</p> <ul style="list-style-type: none"> <li data-bbox="486 778 829 808">► Close the fuel filler cap. <li data-bbox="486 819 1674 849">► If the fuel filler cap was already properly closed: consult a qualified specialist workshop.

Display messages	Possible causes/consequences and ► Solutions
 <p data-bbox="118 301 306 327">Fuel Level Low</p>	<ul style="list-style-type: none"> * The fuel supply has dropped into the reserve range. <ul style="list-style-type: none"> ► Refuel.

Engine oil

Display messages	Possible causes/consequences and ► Solutions
 <p data-bbox="118 622 457 681">Engine Oil Level Cannot Be Measured</p>	<ul style="list-style-type: none"> * The electrical connection to the oil level sensor has been interrupted or the oil level sensor is faulty. <ul style="list-style-type: none"> ► Consult a qualified specialist workshop.
 <p data-bbox="118 823 461 849">Engine Oil Reduce Oil Level</p>	<ul style="list-style-type: none"> * Display message only for certain engines: The engine oil level is too high. <div data-bbox="553 801 1984 909" style="border: 1px solid black; padding: 5px; margin-top: 10px;"> <p data-bbox="574 812 1402 843">! NOTE Engine damage caused by driving with excess engine oil</p> <ul style="list-style-type: none"> ► Avoid long journeys with excess engine oil. </div> <ul style="list-style-type: none"> ► Consult a qualified specialist workshop immediately and have the engine oil siphoned off.

Display messages	Possible causes/consequences and ► Solutions
 <p data-bbox="57 301 380 363">Engine Oil Level Low Stop Vehicle Turn Engine Off</p>	<p data-bbox="466 184 1007 256">* Display message only for certain engines: The engine oil level is too low.</p> <div data-bbox="492 280 1917 387" style="border: 1px solid black; padding: 5px;"> <p data-bbox="513 291 1391 322">! NOTE Engine damage caused by driving with insufficient engine oil</p> <p data-bbox="513 342 1140 373">► Avoid long journeys with insufficient engine oil.</p> </div> <ul data-bbox="486 408 1909 598" style="list-style-type: none"> <li data-bbox="486 408 1909 470">► Pull over and stop the vehicle safely as soon as possible, paying attention to road and traffic conditions. Do not continue driving under any circumstances. <li data-bbox="486 480 805 511">► Switch off the engine. <li data-bbox="486 522 895 553">► Add 1.1 US qt (1 l) engine oil. <li data-bbox="486 563 860 594">► Check the engine oil level. <p data-bbox="486 619 891 650">Top up engine oil (→ page 340).</p> <p data-bbox="486 660 921 692">Notes on engine oil (→ page 405).</p>
 <p data-bbox="57 831 363 894">Engine Oil Pressure Stop Switch Off Engine</p>	<p data-bbox="466 714 1007 787">* Display message only for certain engines: The engine oil pressure is too low.</p> <div data-bbox="492 811 1917 917" style="border: 1px solid black; padding: 5px;"> <p data-bbox="513 821 1508 852">! NOTE Engine damage caused by driving with insufficient engine oil pressure</p> <p data-bbox="513 873 1173 904">► Avoid driving with insufficient engine oil pressure.</p> </div>

Display messages	Possible causes/consequences and ► Solutions
	<ul style="list-style-type: none"> ► Pull over and stop the vehicle safely as soon as possible, paying attention to road and traffic conditions. Do not continue driving under any circumstances. ► Consult a qualified specialist workshop.
<div style="text-align: center;">  </div> <p data-bbox="118 425 406 487">Check Engine Oil Level (Add 1 quart)</p>	<p data-bbox="527 311 1228 381">* Display message only for certain engines: The engine oil level has dropped to the minimum level.</p> <div style="border: 1px solid black; padding: 5px; margin: 10px 0;"> <p data-bbox="578 417 1457 446">! NOTE Engine damage caused by driving with insufficient engine oil</p> <ul style="list-style-type: none"> ► Avoid long journeys with insufficient engine oil. </div> <ul style="list-style-type: none"> ► When next refueling, add 1 quart of engine oil. <p data-bbox="553 586 956 615">Top up engine oil (→ page 340).</p> <p data-bbox="553 627 983 656">Notes on engine oil (→ page 405).</p>



Transmission

Display messages	Possible causes/consequences and ► Solutions
<p data-bbox="118 845 441 907">Transmission Malfunction Stop</p>	<p data-bbox="527 837 1651 866">* The transmission is malfunctioning. The transmission shifts to position N automatically.</p> <ul style="list-style-type: none"> ► Pull over and stop the vehicle safely as soon as possible, paying attention to road and traffic conditions. ► Switch the transmission to position P.





Display messages	Possible causes/consequences and ► Solutions
<p>N Permanently Active Risk of Rolling Away</p>	<ul style="list-style-type: none"> ► Consult a qualified specialist workshop. * While the vehicle is rolling or while you are driving, the transmission has been shifted to position N. <ul style="list-style-type: none"> ► Depress the brake pedal to stop and, when the vehicle is stationary, shift the transmission to position P. ► To continue your journey, shift the transmission to position D or R.
<p>Stop Vehicle Leave Engine Running Wait Transmission Cooling</p>	<ul style="list-style-type: none"> * The transmission is overheating. Pulling away may be temporarily impaired or not possible. <ul style="list-style-type: none"> ► Pull over and stop the vehicle safely as soon as possible, paying attention to road and traffic conditions. Do not continue driving under any circumstances. ► Leave the engine running. ► Wait until the display message disappears before pulling away.
<p>To Deselect P or N, Depress Brake and Start Engine</p>	<ul style="list-style-type: none"> * You have attempted to shift the transmission out of position P or N into another transmission position. <ul style="list-style-type: none"> ► Depress the brake pedal. ► Start the engine.
<p>Apply Brake to Shift from 'P'</p>	<ul style="list-style-type: none"> * You have attempted to shift the transmission out of position P and into another transmission position. <ul style="list-style-type: none"> ► Depress the brake pedal.
<p>Service Required Do Not Shift Gears Visit Dealer</p>	<ul style="list-style-type: none"> * The transmission is malfunctioning. The transmission position can no longer be shifted. <ul style="list-style-type: none"> ► When the transmission is in position D, consult a qualified specialist workshop and do not change the transmission position. ► For all other transmission positions, park the vehicle safely.

Display messages	Possible causes/consequences and ► Solutions
	<ul style="list-style-type: none"> ► Consult a qualified specialist workshop or breakdown service.
Reversing Not Possible Service Required	<ul style="list-style-type: none"> * The transmission is malfunctioning. Reverse gear can no longer be engaged. ► Visit a qualified specialist workshop.
Only Shift to 'P' when Vehicle is Stationary	<ul style="list-style-type: none"> * The transmission can only be shifted to position P when the vehicle is stationary.
Driver's Door Open & Transmission Not in P Risk of Vehicle Rolling Away	<ul style="list-style-type: none"> * The driver's door is not fully closed and the transmission is in position R, N or D. ► Shift the transmission to position P when you park the vehicle.
To Engage Transmiss. Position R First Depress the Brake	<ul style="list-style-type: none"> * You have tried to switch to transmission position R. ► Depress the brake pedal. ► Shift the transmission to position R.
Auxiliary Battery Malfunction	<ul style="list-style-type: none"> * The auxiliary battery for the transmission is no longer being charged. ► Visit a qualified specialist workshop. ► Until then, manually set the transmission to position P before you switch off the engine. ► Before leaving the vehicle, apply the electric parking brake.

Tires

Display messages	Possible causes/consequences and ► Solutions
 <p data-bbox="57 350 369 379">Warning Tire Malfunction</p>	<p data-bbox="466 236 1637 265">* The tire pressure in one or more tires has dropped suddenly. The wheel position is displayed.</p> <div data-bbox="492 288 1917 339" style="background-color: #f0f0f0; padding: 5px;"> <p data-bbox="517 298 1279 327">▲ WARNING Risk of an accident from driving with a flat tire</p> <p data-bbox="513 350 1079 379">Flat tires are dangerous in the following ways:</p> <ul data-bbox="523 391 1596 462" style="list-style-type: none"> <li data-bbox="523 391 1044 420">• The tires can overheat and cause a fire. <li data-bbox="523 433 1596 462">• The driving characteristics, as well as steering and braking, may be greatly impaired. <p data-bbox="513 484 1030 513">You could then lose control of the vehicle.</p> <ul data-bbox="513 526 942 596" style="list-style-type: none"> <li data-bbox="513 526 895 555">► Do not drive with a flat tire. <li data-bbox="513 567 942 596">► Observe the notes on flat tires. </div> <p data-bbox="492 636 901 665">Notes on flat tires (→ page 355).</p> <ul data-bbox="492 677 1324 747" style="list-style-type: none"> <li data-bbox="492 677 1324 706">► Stop the vehicle, paying attention to road and traffic conditions. <li data-bbox="492 718 731 747">► Check the tires.
 <p data-bbox="57 888 206 917">Check Tires</p>	<p data-bbox="466 770 1678 799">* The tire pressure in one or more tires has dropped significantly. The wheel position is displayed.</p>

Display messages	Possible causes/consequences and ► Solutions
	<p>▲ WARNING Risk of an accident due to insufficient tire pressure</p> <p>Tire pressures that are too low pose the following hazards:</p> <ul style="list-style-type: none">• The tires may burst, especially as the load and vehicle speed increase.• The tires may wear excessively and/or unevenly, which may greatly impair tire traction.• The driving characteristics, as well as steering and braking, may be greatly impaired. <p>You could then lose control of the vehicle.</p> <ul style="list-style-type: none">► Observe the recommended tire pressure.► Adjust the tire pressure if necessary. <ul style="list-style-type: none">► Stop the vehicle, paying attention to road and traffic conditions.► Check the tire pressure (→ page 371) and the tires.
 <p>Please Correct Tire Pressure</p>	<p>* The tire pressure is too low in at least one of the tires, or the tire pressure difference between the wheels is too great.</p> <ul style="list-style-type: none">► Check the tire pressure and add air, if necessary.► When the tire pressure is correct, restart the tire pressure monitoring system (→ page 376).

Display messages	Possible causes/consequences and ► Solutions
 <p data-bbox="57 301 355 363">Tire Press. Monitor Currently Unavailable</p>	<ul style="list-style-type: none"> <li data-bbox="466 184 1902 249">* There is interference from a powerful radio signal source. As a result, no signals from the tire pressure sensor are received. The tire pressure monitoring system is temporarily unavailable. <ul style="list-style-type: none"> <li data-bbox="492 260 1766 325">► Drive on. The tire pressure monitoring system restarts automatically as soon as the cause has been rectified.
 <p data-bbox="57 500 363 529">Wheel Sensor(s) Missing</p>	<ul style="list-style-type: none"> <li data-bbox="466 383 1851 490">* The tire pressure sensor signal is missing from one or more tire(s). The pressure of the affected tire is not displayed. <ul style="list-style-type: none"> <li data-bbox="492 458 1561 487">► Have the defective tire pressure sensor replaced at a qualified specialist workshop.
 <p data-bbox="57 666 400 726">Tire Pressure Monitor Inoperative No Wheel Sensors</p>	<ul style="list-style-type: none"> <li data-bbox="466 549 1917 622">* The wheels installed do not have suitable tire pressure sensors. The tire pressure monitoring system is deactivated. <ul style="list-style-type: none"> <li data-bbox="492 591 1146 620">► Install wheels with suitable tire pressure sensors.
 <p data-bbox="57 862 406 923">Tire Press. Monitor Inoperative</p>	<ul style="list-style-type: none"> <li data-bbox="466 745 1095 774">* The tire pressure monitoring system is defective. <div data-bbox="492 798 1923 845" style="background-color: #f0f0f0; padding: 5px;"> <p data-bbox="513 809 1759 843">⚠ WARNING There is a risk of an accident if the tire pressure monitoring system is malfunctioning</p> </div> <p data-bbox="513 860 1896 919">If the tire pressure monitoring system is malfunctioning, it is not able to issue a warning if there is pressure loss in one or more of the tires.</p>

Display messages	Possible causes/consequences and ► Solutions
	<p>Underinflated tires may, for example, impair the driving, steering and braking characteristics.</p> <ul style="list-style-type: none"> ► Have the tire pressure monitoring system checked at a qualified specialist workshop. <p>► Visit a qualified specialist workshop.</p>
Tires Overheated	<p>* At least one tire is overheating. The affected tires are displayed in red. At temperatures close to the limit value, the tires are displayed in yellow.</p> <ul style="list-style-type: none"> ► Drive more slowly.
Decrease Speed	<p>* At least one tire is overheating. The affected tires are displayed in red. At temperatures close to the limit value, the tires are displayed in yellow.</p> <div style="background-color: #f0f0f0; padding: 5px; margin-bottom: 10px;"> <p>▲ WARNING Risk of an accident from driving with overheated tires</p> </div> <p>Overheated tires may burst, particularly at high speeds.</p> <ul style="list-style-type: none"> ► Reduce speed so that the tires cool down. <p>► Reduce speed so that the tires cool down.</p>

SmartKey

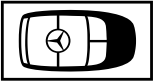
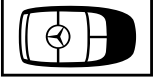
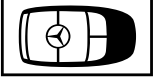
Display messages	Possible causes/consequences and ► Solutions
 <p data-bbox="57 350 398 415">Key Not Detected (red display message)</p>	<p data-bbox="466 236 1365 267">* The SmartKey cannot be detected and may no longer be in the vehicle.</p> <p data-bbox="486 277 1365 308">The SmartKey is no longer in the vehicle and you switch off the engine:</p> <ul data-bbox="498 322 997 391" style="list-style-type: none"> <li data-bbox="498 322 968 353">• You can no longer start the engine. <li data-bbox="498 363 997 391">• You cannot centrally lock the vehicle. <p data-bbox="486 415 1105 446">► Make sure that the SmartKey is in the vehicle.</p> <p data-bbox="486 477 1590 508">If the SmartKey detection function has a malfunction due to a strong radio signal source:</p> <ul data-bbox="486 519 1821 591" style="list-style-type: none"> <li data-bbox="486 519 1821 550">► Pull over and stop the vehicle safely as soon as possible, paying attention to road and traffic conditions. <li data-bbox="486 560 1739 591">► Place the SmartKey in the marked space for starting the engine with the SmartKey (→ page 127).
 <p data-bbox="57 733 282 764">Obtain a New Key</p>	<p data-bbox="466 619 942 650">* The SmartKey needs to be replaced.</p> <ul data-bbox="486 660 983 692" style="list-style-type: none"> <li data-bbox="486 660 983 692">► Visit a qualified specialist workshop.
 <p data-bbox="57 899 369 959">Key Not Detected (white display message)</p>	<p data-bbox="466 785 962 816">* The SmartKey is currently undetected.</p> <ul data-bbox="486 826 1892 899" style="list-style-type: none"> <li data-bbox="486 826 1167 857">► Change the location of the SmartKey in the vehicle. <li data-bbox="486 868 1892 899">► If the SmartKey is still not recognized, start the engine with the SmartKey in the marked space (→ page 127).

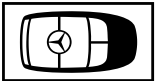
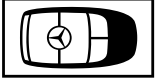
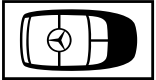
Display messages	Possible causes/consequences and ► Solutions
 <p data-bbox="118 298 374 329">Replace Key Battery</p>	<ul style="list-style-type: none"> <li data-bbox="519 184 1003 215">* The SmartKey battery is discharged. <li data-bbox="551 225 1017 256">► Replace the battery (→ page 64).
 <p data-bbox="118 469 451 557">Place the Key in the Marked Space See Operator's Manual</p>	<ul style="list-style-type: none"> <li data-bbox="519 355 1187 386">* The SmartKey detection function is malfunctioning. <li data-bbox="551 396 1234 427">► Change the location of the SmartKey in the vehicle. <li data-bbox="551 438 1483 469">► Start the vehicle with the SmartKey in the marked space (→ page 127).
 <p data-bbox="118 697 396 728">Don't Forget Your Key</p>	<ul style="list-style-type: none"> <li data-bbox="519 583 1913 640">* A warning tone will also sound. This message reminds you to take your SmartKey with you when you leave the vehicle.

Vehicle

Display messages	Possible causes/consequences and ► Solutions
	<ul style="list-style-type: none"> <li data-bbox="519 903 1058 934">* The differential locks are malfunctioning.

Display messages	Possible causes/consequences and ► Solutions
<p>Front/Rear Differential Lock System Malfunction</p>	<p>Other driving systems and driving safety systems may also malfunction.</p> <p>▲ WARNING Risk of accident in the event of a malfunction with the driving and driving safety systems</p> <p>If the differential locks are malfunctioning, the ABS, ESP[®], ETS/4ETS and BAS driving and driving safety systems may also malfunction.</p> <p>The wheels may lock when braking. The braking distance in an emergency braking situation can increase.</p> <ul style="list-style-type: none"> ▶ Drive on carefully. ▶ Visit a qualified specialist workshop immediately. <p>► Drive on carefully.</p> <p>► Visit a qualified specialist workshop immediately.</p>
<p>Differential Lock Engaged ABS and ESP Unavailable</p>	<p>* ABS and ESP[®] are not available when the differential locks are switched on.</p> <p>Other driving and driving safety systems may also be unavailable.</p> <p>The brake system continues to operate normally. The braking distance in an emergency braking situation can increase.</p> <p>▲ WARNING Risk of skidding if ABS and ESP[®] are unavailable</p> <p>If ABS and ESP[®] are unavailable, the wheels could lock when braking and ESP[®] cannot perform vehicle stabilization.</p>



Display messages	Possible causes/consequences and ► Solutions
	<p>The steering capability and braking characteristics are thus severely impaired. The braking distance in an emergency braking situation can increase. In addition, other driving safety systems are switched off.</p> <ul style="list-style-type: none"> ► Drive on carefully. ► Switch on the differential locks only for off-road driving. ► Switch off the differential locks immediately after off-road driving. <ul style="list-style-type: none"> ► Drive on carefully. ► Switch on the differential locks only for off-road driving. ► Switch off the differential locks immediately after off-road driving.
<p>Desert Drive Program Act. ESP Unavailable See Operator's Manual</p>	<p>* ABS and ESP[®] are restricted in the Desert drive program. Other driving and driving safety systems may also be unavailable. The brake system continues to operate normally. The braking distance in an emergency braking situation can increase.</p> <div style="background-color: #f0f0f0; padding: 5px;"> <p>▲ WARNING Risk of skidding if ABS and ESP[®] are restricted</p> </div> <p>If ABS and ESP[®] are restricted, the wheels could lock when braking and ESP[®] cannot perform vehicle stabilization. The steering capability and braking characteristics are thus severely impaired. The braking distance in an emergency braking situation can increase. In addition, other driving safety systems are switched off.</p>



Display messages	Possible causes/consequences and ► Solutions
	<ul style="list-style-type: none"> ▶ Drive on carefully. ▶ Activate the Desert drive program only when driving on sand. ▶ Deactivate the Desert drive program immediately after driving on sand. <ul style="list-style-type: none"> ▶ Drive on carefully. ▶ Activate the Desert drive program only when driving on sand. ▶ Deactivate the Desert drive program immediately after driving on sand.
<p>LOW RANGE Stop Apply Parking Brake</p>	<p>* There is a transfer case malfunction.</p> <ul style="list-style-type: none"> ▶ Pull over and stop the vehicle safely as soon as possible, paying attention to road and traffic conditions. ▶ Apply the electric parking brake. ▶ Where necessary, also secure the vehicle against rolling away. ▶ Switch the transmission to position P.
 <p>Different. Lock Sys. Malfunction</p>	<p>* There is a transfer case malfunction.</p> <ul style="list-style-type: none"> ▶ Do not shift the transfer case. ▶ Use the electric parking brake to secure the vehicle against rolling away. ▶ Visit a qualified specialist workshop.
<p>Disengage LOW RANGE Differential Locks</p>	<p>* One or several shifting conditions were not met.</p>

Display messages	Possible causes/consequences and ► Solutions
	<ul style="list-style-type: none"> ► To engage HIGH RANGE, the differential locks must be switched off. ► Repeat the gear change.
LOW RANGE Malfunction	<ul style="list-style-type: none"> * There is a transfer case malfunction. ► Do not shift the transfer case. ► Use the electric parking brake to secure the vehicle against rolling away. ► Visit a qualified specialist workshop.
LOW RANGE Shift to Position N Briefly	<ul style="list-style-type: none"> * One or several shifting conditions were not met. ► Switch the transmission to position N. ► Repeat the gear change.
LOW RANGE Max. Speed 25 mph	<ul style="list-style-type: none"> * The maximum speed for changing gear of 25 mph (40 km/h) has been exceeded. ► Drive more slowly. ► Repeat the gear change.
LOW RANGE Malfunction To Park, Apply Brake	<ul style="list-style-type: none"> * There is a transfer case malfunction. ► Do not shift the transfer case. ► Use the electric parking brake to secure the vehicle against rolling away. ► Visit a qualified specialist workshop.
	<ul style="list-style-type: none"> * The maximum speed for changing gear of 40 mph (70 km/h) has been exceeded.

Display messages	Possible causes/consequences and ► Solutions
<p>LOW RANGE Max. Speed 40 mph</p>	<ul style="list-style-type: none"> ► Drive more slowly. ► Repeat the gear change.
<p>Gearbox Protection Limit 18 mph Disable LOW RANGE</p>	<ul style="list-style-type: none"> * The oil temperature in the transfer case is too high. <ul style="list-style-type: none"> ► In the on-road position, shift to HIGH RANGE.
<div style="border: 1px solid black; width: 40px; height: 40px; margin: 0 auto; display: flex; align-items: center; justify-content: center;">  </div> <p>Different. Locking Sys. Cooling Down Please Wait</p>	<ul style="list-style-type: none"> * The differential locks are overheated. <ul style="list-style-type: none"> ► Wait briefly.
<p>LOW RANGE Shifting Can- celed Please Reactivate</p>	<ul style="list-style-type: none"> * The transfer case did not perform the gear change. <ul style="list-style-type: none"> ► Repeat the gear change. ► Ensure all shifting conditions are met (→ page 144).
<p>LOW RANGE Max. Speed 6 mph</p>	<ul style="list-style-type: none"> * The maximum speed for changing gear of 6 mph (10 km/h) has been exceeded. <ul style="list-style-type: none"> ► Drive more slowly. ► Repeat the gear change.
<p>LOW RANGE Max. Speed 12 mph</p>	<ul style="list-style-type: none"> * The maximum speed for changing gear of 12 mph (20 km/h) has been exceeded. <ul style="list-style-type: none"> ► Drive more slowly.

Display messages	Possible causes/consequences and ► Solutions
	<ul style="list-style-type: none"> ► Repeat the gear change.
<p>Speed Max. 6 mph (yellow display message)</p>	<ul style="list-style-type: none"> * The maximum reliable speed for fording of 6 mph (10 km/h) has been exceeded. ► Drive more slowly.
<p>Fording Not Possible Service Required</p>	<ul style="list-style-type: none"> * There is a malfunction with the air flap of the air intake. Fording is not possible. ► Drive on carefully. ► Visit a qualified specialist workshop.
<p>Air Intake Malfunction See Operator's Manual</p>	<ul style="list-style-type: none"> * The air flap of the air intake is dirty or iced up. Fording is not possible. ► At outside temperatures above 39 °F (4 °C), re-start the engine. ► If you have already started fording, drive on carefully. ► Clean the vehicle. ► Defrost the air intake.
	<ul style="list-style-type: none"> * The steering is malfunctioning Steering capability is considerably impaired. <div style="background-color: #e0e0e0; padding: 5px; margin-top: 10px;"> <p>▲ WARNING Risk of accident if steering capability is impaired</p> <p>If the steering does not function as intended, the vehicle's operating safety is jeopardized.</p> </div>





Display messages	Possible causes/consequences and ► Solutions
<p>Steering Malfunction Stop Immediately See Operator's Manual</p>	<ul style="list-style-type: none"> ► Pull over and stop the vehicle safely as soon as possible, paying attention to road and traffic conditions. Do not continue driving under any circumstances. ► Consult a qualified specialist workshop. <ul style="list-style-type: none"> ► Pull over and stop the vehicle safely as soon as possible, paying attention to road and traffic conditions. Do not continue driving under any circumstances. ► Consult a qualified specialist workshop.
 <p>Steering Malfunction Increased Physical Effort See Operator's Manual</p>	<p>* The power assistance for the steering is malfunctioning.</p> <p>⚠ WARNING Risk of an accident due to altered steering characteristics</p> <p>If the power assistance of the steering fails partially or completely, you will need to use more force to steer.</p> <ul style="list-style-type: none"> ► If safe steering is possible, drive on carefully. ► Visit or consult a qualified specialist workshop immediately. <ul style="list-style-type: none"> ► If safe steering is possible, drive on carefully. ► Visit or consult a qualified specialist workshop immediately.
	<p>* The hood is open.</p> <p>⚠ WARNING Risk of accident if the engine hood is unlatched while driving</p> <p>An unlocked engine hood may open up when the vehicle is in motion and block your view.</p>

Display messages	Possible causes/consequences and ► Solutions
	<ul style="list-style-type: none"> ▶ Never unlatch the engine hood while driving. ▶ Before every trip, ensure that the engine hood is latched. <ul style="list-style-type: none"> ▶ Stop the vehicle immediately, paying attention to road and traffic conditions. ▶ Close the hood.
	<ul style="list-style-type: none"> * At least one door is open. ▶ Close all doors.
 <p data-bbox="124 605 369 629">Check Washer Fluid</p>	<ul style="list-style-type: none"> * The washer fluid level in the washer fluid reservoir has dropped below the minimum. ▶ Add washer fluid (→ page 342).

Lights

Display messages	Possible causes/consequences and ► Solutions
	<ul style="list-style-type: none"> * The Intelligent Light System is defective. The lighting system continues to function properly without the functions of the Intelligent Light System. ▶ Visit a qualified specialist workshop.

Display messages	Possible causes/consequences and ► Solutions
<p>Intell. Light System Inoperative</p>	
<div data-bbox="69 270 263 373" data-label="Image"> </div> <p>Check Left Low Beam (Example)</p>	<ul style="list-style-type: none"> * The corresponding light source is defective. <ul style="list-style-type: none"> ► Drive on carefully. ► Visit a qualified specialist workshop immediately. ⓘ LED light bulbs: the display message for the corresponding lamp appears only when all the light-emitting diodes in the lamp have failed.
<div data-bbox="69 480 263 584" data-label="Image"> </div> <p>Active Headlamps Inoperative</p>	<ul style="list-style-type: none"> * The active headlamps are defective. <ul style="list-style-type: none"> ► Visit a qualified specialist workshop.
<div data-bbox="69 677 263 781" data-label="Image"> </div> <p>Switch Off Lights</p>	<ul style="list-style-type: none"> * You are leaving the vehicle and the lights are still switched on. <ul style="list-style-type: none"> ► Turn the light switch to the AUTO position.
<div data-bbox="69 843 263 946" data-label="Image"> </div>	<ul style="list-style-type: none"> * The exterior lighting is defective. <ul style="list-style-type: none"> ► Visit a qualified specialist workshop. Vehicles with a trailer hitch: A fuse may have blown.

Display messages	Possible causes/consequences and ► Solutions
<p>Malfunction See Operator's Manual</p>	<ul style="list-style-type: none"> ► Pull over and stop the vehicle safely as soon as possible, paying attention to road and traffic conditions. ► Check the fuses and replace them if necessary (→ page 367).
<div style="text-align: center;">  </div> <p>Switch On Headlamps</p>	<ul style="list-style-type: none"> * You are driving without low-beam headlamps. <ul style="list-style-type: none"> ► Turn the light switch to the  or AUTO position.
<div style="text-align: center;">  </div> <p>Automatic Headlamp Mode Inoperative</p>	<ul style="list-style-type: none"> * The light sensor is faulty. <ul style="list-style-type: none"> ► Consult a qualified specialist workshop.
<div style="text-align: center;">  </div> <p>Hazard Warning Flashers Malfunctioning</p>	<ul style="list-style-type: none"> * The hazard warning light switch is defective. <ul style="list-style-type: none"> ► Visit a qualified specialist workshop.
<p>Adaptive Highbeam Assist Inoperative</p>	<ul style="list-style-type: none"> * Adaptive Highbeam Assist is malfunctioning. <ul style="list-style-type: none"> ► Visit a qualified specialist workshop.
	<ul style="list-style-type: none"> * Adaptive Highbeam Assist is temporarily unavailable.

Display messages	Possible causes/consequences and ► Solutions
<p>Adaptive Highbeam Assist Currently Unavailable See Operator's Manual</p>	<p>The system limits have been reached (→ page 111).</p> <ul style="list-style-type: none"> ► Drive on. Once the cause of the problem is no longer present, the system will be available again. The Adaptive Highbeam Assist Now Available display message appears.
<p>Adaptive Highbeam Assist Camera View Restricted See Operator's Manual</p>	<p>* The camera view is restricted. Possible causes are:</p> <ul style="list-style-type: none"> • Dirt on the windshield in the camera's field of vision • Heavy rain, snow or fog <p>Driving systems and driving safety systems may be malfunctioning or temporarily unavailable. Once the cause of the problem is no longer present, driving systems and driving safety systems will be available again.</p> <p>If the display message does not disappear:</p> <ul style="list-style-type: none"> ► Pull over and stop the vehicle safely as soon as possible, paying attention to road and traffic conditions. ► Clean the windshield.

Warning and indicator lamps

Overview of warning and indicator lamps

Some systems will perform a self-test when the ignition is switched on. Some warning and indicator lamps may briefly light up or flash. This

behavior is non-critical. These warning and indicator lamps indicate a malfunction only if they light up or flash after the engine has been started or during a journey.

Instrument Display (standard)

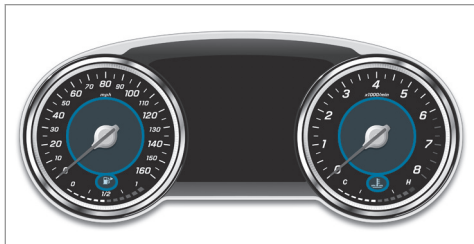

Widescreen Cockpit Instrument Display









Progressive setting



Vehicles with a Widescreen Cockpit: If you select the progressive display setting, the positions of the indicator lamps on the Instrument Display will change.

Warning and indicator lamps:

-  Low beam (→ page 109)
-  Parking lights (→ page 109)
-  High beam (→ page 110)
-  Turn signal indicators (→ page 110)
-  Rear fog light (→ page 109)
-  Restraint system (→ page 460)



Seat belt not fastened (→ page 465)



USA: brakes (red) (→ page 460)



Canada: brakes (red) (→ page 460)



Electric parking brake (yellow)
(→ page 460)



USA: electric parking brake applied
(red) (→ page 460)



Canada: electric parking brake
applied (red) (→ page 460)



ABS malfunction (→ page 460)



ESP® (→ page 460)



ESP® OFF (→ page 460)



Distance warning (→ page 466)



Power-assisted steering malfunction
(→ page 471)



Off-road gear (→ page 143)



On-road position (→ page 143)



Check Engine (→ page 467)



Electrical malfunction (→ page 467)



Fuel reserve with fuel filler cap location indicator (→ page 467)
(→ page 467)



Coolant too hot/cold (→ page 467)



Tire pressure monitor (→ page 469)



Trailer hitch not operational
(→ page 471)

Safety systems

Warning/indicator lamp



Red indicator lamp, electric parking brake applied (USA only)





Red indicator lamp, electric parking brake applied (Canada only)



Possible causes/consequences and ► Solutions

The red electric parking brake indicator lamp flashes or is lit. The yellow indicator lamp is also lit if the electric parking brake malfunctions.

- Observe the messages on the multifunction display.

Warning/indicator lamp	Possible causes/consequences and ► Solutions
<p>Yellow electric parking brake indicator lamp is malfunctioning</p>	
 <p>ESP® warning lamp flashes</p>	<p>The yellow ESP® warning lamp flashes while the vehicle is in motion. At least one wheel and tire assembly has reached its traction limit (→ page 160).</p> <p>► Adapt your driving style to suit the road and weather conditions.</p>
 <p>ESP® OFF warning lamp</p>	<p>The yellow ESP® OFF warning lamp is lit while the engine is running. ESP® is deactivated.</p> <div style="background-color: #f0f0f0; padding: 5px; border: 1px solid #ccc;"> <p>⚠ WARNING Risk of skidding when driving with ESP® deactivated</p> <p>If ESP® is deactivated, ESP® cannot carry out vehicle stabilization. The availability of further driving safety systems is also limited.</p> <ul style="list-style-type: none"> ► Drive on carefully. ► Only deactivate ESP® for as long as the situation requires. <p>If ESP® cannot be activated, ESP® is malfunctioning.</p> <ul style="list-style-type: none"> ► Have ESP® checked immediately at a qualified specialist workshop. </div> <p>► Observe the notes on deactivating ESP® (→ page 160).</p>

Warning/indicator lamp



Brake warning lamp (USA)



Brakes warning lamp (Canada)

Possible causes/consequences and ► Solutions

The red brake system warning lamp is lit while the engine is running.

Possible causes are:

- The brake force boosting is malfunctioning and the braking characteristics may be affected.
- There is not enough brake fluid in the brake fluid reservoir.

▲ WARNING Risk of accident and injury if brake force boosting is malfunctioning

If brake force boosting is malfunctioning, increased brake pedal force may be necessary for braking. The braking characteristics may be impaired. The braking distance can increase in emergency braking situations.

- ▶ Stop in a safe location immediately. Do not continue driving.
- ▶ Consult a qualified specialist workshop.

▲ WARNING Risk of an accident due to low brake fluid level

If the brake fluid level is too low, the braking effect and the braking characteristics may be impaired.

- ▶ Pull over and stop the vehicle safely as soon as possible, paying attention to road and traffic conditions. Do not continue driving under any circumstances.
- ▶ Consult a qualified specialist workshop.
- ▶ Do not add brake fluid.

- ▶ Pull over and stop the vehicle safely as soon as possible, paying attention to road and traffic conditions. Do not continue driving under any circumstances.

Warning/indicator lamp	Possible causes/consequences and ► Solutions
	<ul style="list-style-type: none"> ► Observe the messages on the multifunction display. ► Consult a qualified specialist workshop.
 <p>ABS warning lamp</p>	<p>The yellow ABS warning lamp is lit while the engine is running. ABS is malfunctioning.</p> <p>If there is an additional warning tone, EBD is malfunctioning.</p> <p>Other driving systems and driving safety systems may also malfunction.</p> <div style="background-color: #e0e0e0; padding: 5px; margin: 10px 0;"> <p>⚠ WARNING There is risk of skidding if EBD or ABS is malfunctioning</p> <p>If EBD or ABS is malfunctioning, the wheels could lock when braking. The steering capability and braking characteristics are thus severely impaired. The braking distance in an emergency braking situation can increase. In addition, other driving safety systems are switched off.</p> <ul style="list-style-type: none"> ► Drive on carefully. ► Have the brake system checked immediately at a qualified specialist workshop. </div> <ul style="list-style-type: none"> ► Drive on carefully. ► Observe the messages on the multifunction display. ► Visit a qualified specialist workshop.

Warning/indicator lamp



ESP® warning lamp lights up

Possible causes/consequences and ▶ Solutions

The yellow ESP® warning lamp is lit while the engine is running.
 ESP® is malfunctioning
 Other driving systems and driving safety systems may also malfunction.

⚠ WARNING Risk of skidding if ESP® is malfunctioning

If ESP® is malfunctioning, ESP® cannot carry out vehicle stabilization. In addition, other driving safety systems are switched off.

- ▶ Drive on carefully.
- ▶ Have ESP® checked at a qualified specialist workshop.

- ▶ Drive on carefully.
- ▶ Observe the messages on the multifunction display.
- ▶ Visit a qualified specialist workshop.





Restraint system warning lamp

The red restraint system warning lamp is lit while the engine is running.
 The restraint system is faulty (→ page 32).

Warning/indicator lamp	Possible causes/consequences and ► Solutions
	<p data-bbox="523 194 1976 228">  WARNING Risk of injury or fatal injury due to a malfunction in the restraint system </p> <p data-bbox="523 246 1976 339"> If the restraint system is malfunctioning, restraint system components may be triggered unintentionally or might not be triggered at all in the event of an accident. This may affect the Emergency Tensioning Device or airbag, for example. </p> <ul data-bbox="523 355 1976 528" style="list-style-type: none"> <li data-bbox="523 355 1976 389">► Have the restraint system checked and repaired immediately at a qualified specialist workshop. <li data-bbox="523 417 1976 451">► Drive on carefully. <li data-bbox="523 458 1976 493">► Observe the messages on the multifunction display. <li data-bbox="523 500 1976 534">► Visit a qualified specialist workshop immediately.

Seat belts



Warning/indicator lamp	Possible causes/consequences and ► Solutions
 <p data-bbox="118 829 410 888">Seat belt warning lamp flashes</p>	<p data-bbox="502 715 1500 743">The red seat belt warning lamp flashes and an intermittent warning tone sounds.</p> <p data-bbox="502 757 1631 785">The driver or front passenger has not fastened their seat belt while the vehicle is in motion.</p> <ul data-bbox="502 798 1986 899" style="list-style-type: none"> <li data-bbox="502 798 1986 832">► Fasten your seat belt(→ page 36). <li data-bbox="502 836 1986 870">There are objects on the front passenger seat. <li data-bbox="502 873 1986 907">► Remove the objects from the front passenger seat.



Warning/indicator lamp	Possible causes/consequences and ► Solutions
 <p data-bbox="57 301 349 363">Seat belt warning lamp lights up</p>	<p data-bbox="441 184 1528 215">The red seat belt warning lamp will light up for six seconds once the engine has started.</p> <p data-bbox="441 225 921 256">In addition, a warning tone may sound.</p> <p data-bbox="441 267 1586 298">The seat belt warning lamp reminds the driver and front passenger to fasten their seat belts.</p> <ul data-bbox="441 308 921 339" style="list-style-type: none">► Fasten your seat belt (→ page 36). <p data-bbox="441 360 1647 391">If you have placed objects on the front passenger seat, the seat belt warning lamp may remain lit.</p>

Driving systems

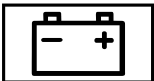
Warning/indicator lamp	Possible causes/consequences and ► Solutions
 <p data-bbox="57 687 384 750">Warning lamp for distance warning function</p>	<p data-bbox="441 570 1310 601">The red distance warning lamp lights up while the vehicle is in motion.</p> <p data-bbox="441 612 1310 643">The distance to the vehicle in front is too small for the speed selected.</p> <p data-bbox="441 653 1565 684">If there is an additional warning tone, you are approaching an obstacle at too high a speed.</p> <ul data-bbox="441 695 911 767" style="list-style-type: none">► Be prepared to brake immediately.► Increase the distance. <p data-bbox="441 788 840 819">Function of Active Brake Assist .</p>

Engine

Warning/indicator lamp	Possible causes/consequences and ► Solutions
 <p data-bbox="118 350 439 412">Engine diagnosis warning lamp</p>	<p data-bbox="500 236 1389 267">The yellow Check Engine warning lamp is lit while the engine is running.</p> <p data-bbox="500 277 1508 308">A malfunction has occurred in the engine, the exhaust system or the fuel system.</p> <p data-bbox="500 319 1584 350">The emission limit values may be exceeded and the engine may be in emergency mode.</p> <p data-bbox="500 360 1972 426">In some states, legal requirements stipulate that you must immediately consult a qualified specialist workshop as soon as the yellow Check Engine warning lamp lights up.</p> <ul style="list-style-type: none"> <li data-bbox="500 437 1543 468">► Have the vehicle checked as soon as possible at a qualified specialist workshop.
 <p data-bbox="118 602 470 665">Electrical malfunction warning lamp</p>	<p data-bbox="500 488 1113 520">The red electrical malfunction warning lamp is lit.</p> <p data-bbox="500 530 977 561">There is a malfunction in the electrics.</p> <ul style="list-style-type: none"> <li data-bbox="500 571 1189 602">► Observe the messages on the multifunction display.
 <p data-bbox="118 803 449 835">Fuel reserve warning lamp</p>	<p data-bbox="500 689 1246 721">The yellow fuel reserve warning lamp lights up while driving.</p> <p data-bbox="500 731 1966 762">There has been pressure loss in the fuel system. The fuel filler cap is not closed correctly or the fuel system is leaking.</p> <ul style="list-style-type: none"> <li data-bbox="500 772 842 803">► Close the fuel filler cap. <p data-bbox="500 835 1169 866">If the fuel filler cap has already been closed correctly:</p> <ul style="list-style-type: none"> <li data-bbox="500 876 997 907">► Visit a qualified specialist workshop.

Warning/indicator lamp	Possible causes/consequences and ► Solutions
 <p data-bbox="57 301 386 329">Fuel reserve warning lamp</p>	<p data-bbox="441 184 1304 215">The yellow fuel reserve warning lamp is lit while the engine is running.</p> <p data-bbox="441 225 1079 256">The fuel supply has dropped into the reserve range.</p> <p data-bbox="441 267 574 298">► Refuel.</p>
 <p data-bbox="57 469 329 497">Coolant warning lamp</p>	<p data-bbox="441 352 1216 383">The red coolant warning lamp is lit while the engine is running.</p> <p data-bbox="441 393 694 424">Possible causes are:</p> <ul data-bbox="451 435 1011 595" style="list-style-type: none"> <li data-bbox="451 435 1011 466">• The temperature sensor is malfunctioning <li data-bbox="451 476 817 507">• The coolant level is too low <li data-bbox="451 518 1011 549">• The air supply to the radiator is obstructed <li data-bbox="451 559 786 590">• The radiator fan is faulty <p data-bbox="441 616 1880 647">If there is an additional warning tone, the coolant temperature has exceeded the maximum permissible temperature.</p> <div data-bbox="441 668 1921 880" style="background-color: #f0f0f0; padding: 10px;"> <p data-bbox="457 678 1154 709">⚠ WARNING Danger of burns when opening the hood</p> <p data-bbox="457 730 1870 792">If you open the hood when the engine has overheated or during a fire in the engine compartment, you could come into contact with hot gases or other escaping operating fluids.</p> <ul data-bbox="457 802 1686 875" style="list-style-type: none"> <li data-bbox="457 802 1205 833">► Before opening the hood, allow the engine to cool down. <li data-bbox="457 844 1686 875">► In the event of a fire in the engine compartment, keep the hood closed and call the fire service. </div>

Warning/indicator lamp	Possible causes/consequences and ► Solutions
	<ul style="list-style-type: none"> ► Pull over and stop the vehicle safely and switch off the engine, paying attention to road and traffic conditions. Do not continue driving under any circumstances. ► Observe the messages on the multifunction display. <p>If the coolant temperature display is at the lower end of the temperature scale:</p> <ul style="list-style-type: none"> ► Consult a qualified specialist workshop. <p>or</p> <ul style="list-style-type: none"> ► Exit the vehicle and keep a safe distance from it until the engine has cooled down. ► Check the coolant level (→ page 341). ► Make sure that the air supply to the radiator is not obstructed. ► Avoiding high loads on the engine, drive to the nearest qualified specialist workshop. In doing so, ensure that the coolant temperature display remains below the red area.



Tires

Warning/indicator lamp	Possible causes/consequences and ► Solutions
	<p>The yellow tire pressure monitoring system warning lamp (pressure loss/malfunction) is lit.</p> <p>The tire pressure monitoring system has detected tire pressure loss in at least one of the tires.</p>

Warning/indicator lamp	Possible causes/consequences and ► Solutions
<p>Tire pressure monitoring system warning lamp lights up</p>	<p>▲ WARNING Risk of an accident due to insufficient tire pressure</p> <p>Tire pressures that are too low pose the following hazards:</p> <ul style="list-style-type: none"> • The tires may burst, especially as the load and vehicle speed increase. • The tires may wear excessively and/or unevenly, which may greatly impair tire traction. • The driving characteristics, as well as steering and braking, may be greatly impaired. <p>You could then lose control of the vehicle.</p> <ul style="list-style-type: none"> ► Observe the recommended tire pressure. ► Adjust the tire pressure if necessary. <p>► Stop the vehicle, paying attention to road and traffic conditions.</p> <p>► Check the tire pressure and the tires.</p>
<p></p> <p>Tire pressure monitoring system warning lamp flashes</p>	<p>The yellow tire pressure monitoring system warning lamp (pressure loss/malfunction) flashes for approximately one minute and then remains lit.</p> <p>The tire pressure monitoring system is defective.</p> <p>▲ WARNING There is a risk of an accident if the tire pressure monitoring system is malfunctioning</p> <p>If the tire pressure monitoring system is malfunctioning, it is not able to issue a warning if there is pressure loss in one or more of the tires.</p> <p>Underinflated tires may, for example, impair the driving, steering and braking characteristics.</p>

Warning/indicator lamp	Possible causes/consequences and ► Solutions
	<ul style="list-style-type: none"> ▶ Have the tire pressure monitoring system checked at a qualified specialist workshop. ▶ Visit a qualified specialist workshop.

Vehicle

Warning/indicator lamp	Possible causes/consequences and ► Solutions
 <p data-bbox="118 581 404 643">Power steering system warning lamp</p>	<p data-bbox="502 467 1467 539">The red power steering system warning lamp is lit while the engine is running. The power steering assistance or the steering itself is malfunctioning.</p> <div data-bbox="502 560 1986 783" style="background-color: #f0f0f0; padding: 10px;"> <p data-bbox="519 570 1320 607">⚠ WARNING Risk of accident if steering capability is impaired</p> <p data-bbox="519 622 1641 653">If the steering does not function as intended, the vehicle's operating safety is jeopardized.</p> <ul style="list-style-type: none"> ▶ Pull over and stop the vehicle safely as soon as possible, paying attention to road and traffic conditions. Do not continue driving under any circumstances. ▶ Consult a qualified specialist workshop. </div> <ul style="list-style-type: none"> ▶ Observe the messages on the multifunction display.
	<p data-bbox="502 855 1050 928">The red trailer tow hitch warning lamp is on. There is a malfunction with the trailer hitch.</p> <ul style="list-style-type: none"> ▶ Have the trailer hitch checked at a qualified specialist workshop.

472 Display messages and warning/indicator lamps

Warning/indicator lamp	Possible causes/consequences and ► Solutions
Trailer tow hitch warning lamp	

1, 2, 3 ...	
4MATIC	146
Function	146
12 V battery	
see Battery (vehicle)	
12 V socket	
see Socket (12 V)	
115 V socket	
see Socket (115 V)	
360° Camera	180
Function	180
Opening the camera cover (rear view camera)	183
Selecting a view	183
Setting favorites	183

A

A/C function	
Activating/deactivating (multimedia system)	123
Switching on/off (control panel)	123
ABS (Anti-lock Brake System)	159

Acceleration	
see Kickdown	
Accident and breakdown management	
Mercedes me connect	291
Acoustic locking verification signal	
Activating/deactivating	63
Activating/deactivating automatic volume adjustment	
Burmester® surround sound system ...	322
Active Brake Assist	
Function/notes	162
Setting	165
Active Distance Assist DISTRONIC	167
Calling up a speed	169
Displays in the Instrument Display	170
Function	167
Increasing/decreasing speed	169
Requirements	169
Steering wheel buttons	169
Storing a speed	169
Switching off/deactivating	169
Switching on/activating	169
System limitations	167

Active Lane Keeping Assist	195
Activating/deactivating	197
Activating/deactivating (multimedia system)	198
Activating/deactivating the warning ...	198
Function	195
Sensitivity (function/notes)	198
Setting the sensitivity	198
System limitations	195
Active Parking Assist	184
Cross Traffic Alert	189
Drive Away Assist	188
Exiting a parking space	187
Function	184
Maneuvering assistance	189
Parking	185
System limitations	184
Active Service System PLUS	
see ASSYST PLUS	
Adaptive cruise control	
see Active Distance Assist DISTRONIC	
Adaptive Highbeam Assist	
Function	111
Switching on/off	112

- Additional value range**
 Setting display content 204
- Additives** 405
 Engine oil 405
 Fuel 405
- Additives (engine oil)**
 see Additives
- Additives (fuel)**
 see Fuel
- Address book**
 see Contacts
- Adjustable damping** 172
- Adjusting the balance/fader**
 Burmester® surround sound system ... 322
- Adjusting the sound focus**
 Burmester® surround sound system ... 322
- Adjusting treble, mid-range and bass settings**
 Burmester® surround sound system ... 322
- After-sales service center**
 see ASSYST PLUS
- Air bag**
 Reduced protection 40
- Air inlet**
 see Air-water duct
- Air pressure**
 see Tire pressure
- Air vents** 125
 Adjusting (front) 125
 Adjusting (rear) 125
- Air vents**
 see Air vents
- Air-recirculation mode** 124
- Air-water duct** 343
 Keeping free 343
- Airbag** 38
 Activation 32
 Front airbag (driver, front passenger) 38
 Installation locations 38
 Knee airbag 38
 Overview 38
 PASSENGER AIR BAG indicator lamp 43
 Protection 39
 Side airbag 38
- Window curtain airbag 38
- Alarm**
 see Panic alarm
- Alarm system**
 see ATA (anti-theft alarm system)
- All-wheel drive**
 see 4MATIC
- Alternative route**
 see Route
- Ambient lighting**
 Setting (multimedia system) 114
- Android Auto** 287
 Connecting a mobile phone 287
 Ending 288
 Information 287
 Overview 287
 Sound settings 288
 Transferred vehicle data 288
- Animals**
 Pets in the vehicle 61
- Anti-lock braking system**
 see ABS (Anti-lock Brake System)

- Anti-skid chains**
 - see Snow chains
- Anti-theft alarm system**
 - see ATA (anti-theft alarm system)
- Anti-theft protection**
 - Immobilizer 76
- Anti-theft protection**
 - see ATA (anti-theft alarm system)
- Anticipatory occupant protection**
 - see PRE-SAFE® (anticipatory occupant protection)
- Apple CarPlay™** 285
 - Connecting an iPhone® 286
 - Ending 287
 - Notes 286
 - Overview 285
 - Sound settings 286
 - Transferred vehicle data 288
- Ashtray**
 - Rear passenger compartment 103
 - Using 102
- Assistance systems**
 - see Driving safety system
- Assistant display**
 - Menu (on-board computer) 206
- ASSYST PLUS** 336
 - Battery disconnection periods 337
 - Displaying the service due date 336
 - Function/notes 336
 - Regular maintenance work 336
 - Special service requirements 336
- ATA (anti-theft alarm system)** 76
 - Activating/deactivating the interior motion sensor 78
 - Arming/disarming the tow-away alarm 77
 - Deactivating the alarm 77
 - Function 76
 - Function of the interior motion sensor .. 78
 - The tow-away alarm function 77
- ATTENTION ASSIST** 190, 191
 - Function 190
 - Setting 191
 - System limitations 190
- Attention assistant**
 - see ATTENTION ASSIST
- Audio mode**
 - Activating media mode 301
 - Connecting USB devices 304
 - Copyrights 301
 - Information 300
 - Inserting/removing an SD card 301
 - Media search 307
 - Overview 303
 - Pause and playback function 304
 - Selecting a track 304
 - Selecting playback options 304
 - Track list 304
- Authorized Mercedes-Benz Center**
 - see Qualified specialist workshop
- Authorized workshop**
 - see Qualified specialist workshop
- Automatic distance control**
 - see Active Distance Assist DISTRONIC
- Automatic driving lights** 110
- Automatic engine start (ECO start/stop function)** 133
- Automatic engine stop (ECO start/stop function)** 133

- Automatic front passenger front airbag shutoff** 41, 43
 - Function of the automatic front passenger front airbag shutoff 41
 - PASSENGER AIR BAG indicator lamp 43
 - Automatic front passenger front airbag shutoff**
 - see Automatic front passenger front airbag shutoff
 - Automatic lateral support adjustment**
 - Setting 84
 - Automatic mirror folding function**
 - Activating/deactivating 120
 - Automatic transmission**
 - DIRECT SELECT lever 138
 - Drive program display 136
 - Drive programs 135
 - DYNAMIC SELECT switch 135
 - Engaging drive position 139
 - Engaging neutral 139
 - Engaging park position 139
 - Engaging reverse gear 139
 - Kickdown 141
 - Manual gearshifting 140
 - Steering wheel paddle shifters 140
 - Transmission position display 138
 - Transmission positions 138
 - Automatic transmission (problem)**
 - see Transmission (problem)
 - Axle load**
 - Towing a trailer 412
- B**
- Bag hook** 100
 - BAS (Brake Assist System)** 160
 - Battery**
 - SmartKey 64
 - Battery**
 - see Battery (vehicle)
 - Battery (vehicle)** 361
 - Charging 360
 - Notes 357
 - Notes (starting assistance and charging) 359
 - Replacing 361
 - Starting assistance 360
 - Belt**
 - see Seat belt
 - Blind Spot Assist** 193
 - Activating/deactivating 195
 - Function 193
 - System limitations 193
 - Bluetooth®** 238
 - Activating/deactivating 238
 - Information 238
 - Bluetooth® audio**
 - Activating 312
 - De-authorizing (de-registering) the device 312
 - Information 310
 - Overview 310
 - Searching for a track 312
 - Searching for and authorizing the device 311
 - Selecting a media player 312
 - Switching device via NFC 312
 - Brake Assist System**
 - see BAS (Brake Assist System)
 - Brake fluid**
 - Notes 406

Brake force distribution

EBD (electronic brake force distribution) 162

Brakes

ABS (Anti-lock Braking System) 159
 Active Brake Assist 162
 BAS (Brake Assist System) 160
 Driving tips 128
 EBD (electronic brake force distribution) 162
 HOLD function 171
 Limited braking effect (salt-treated roads) 128
 New/replaced brakepads/brake discs 128
 Notes on breaking-in a new vehicle 128

Braking assistance

see BAS (Brake Assist System)

Breakdown

Changing a wheel 393
 Overview of the help functions 16
 Recovering 364
 Roadside Assistance 21
 Tow-starting 367
 Towing away 363

Towing away in the event of front axle damage 365
 Towing away in the event of malfunctions 365
 Towing away in the event of rear axle damage 365
 Towing away, various malfunctions (notes) 365
 Transporting the vehicle 365

Breakdown

see Flat tire

Burmester® surround sound system 321

Adjusting the balance/fader 322
 Adjusting the sound focus 322
 Adjusting treble, mid-range and bass settings 322
 Automatic volume adjustment 322
 Calling up the sound menu 321
 Information 321
 Switching the surround sound on/off 322

Buttons

Steering wheel 202

C**Call list**

Making a call 283
 Overview 282

Calling up the sound menu

Burmester® surround sound system 321

Calls 279

Accepting 279
 Activating functions during a call 279
 Calls with several participants 279
 Declining 279
 Ending a call 279
 Incoming call during an existing call 280
 Making 279
 Via the overhead control panel (Mercedes me connect) 290

Camera

see 360° Camera
 see Rear view camera

Car key

see SmartKey

Car wash

see Care

- Car wash (care)** 343
- Care** 350
 - Air-water duct 343
 - Car wash 343
 - Carpet 350
 - Decorative foil 346
 - Display 350
 - Exterior lighting 348
 - Headliner 350
 - Matte finish 345
 - Paintwork 345
 - Plastic trim 350
 - Power washer 343
 - Real wood/trim elements 350
 - Rear view camera 348
 - Seat belts 350
 - Seat cover 350
 - Sensors 348
 - Tailpipes 348
 - Trailer tow hitch 348
 - Washing by hand 344
 - Wheels/rims 348
 - Windows 348
 - Wiper blades 348
- Cargo compartment cover**
 - Extending/retracting 97
 - Removing/installing 98
- Cargo tie-down rings** 100
- Carpet (Care)** 350
- Change of address** 21
- Change of ownership** 21
- Changing a wheel**
 - Preparation 393
 - Raising the vehicle 393
- Changing a wheel**
 - see Emergency spare wheel
- Changing gears** 140
 - Manually 140
- Changing hub caps** 393
- Character entry**
 - On the touchpad 235
 - Using the controller 235
- Charging**
 - Battery (vehicle) 360
 - Mobile phone (wireless) 106
 - USB port 106
- Child safety lock**
 - Activating/deactivating (multimedia system) 241
 - Rear door 59
 - Rear side windows 60
- Child seat**
 - Attaching (notes) 51
 - Basic instructions 46
 - front-passenger seat (notes) 57
 - LATCH-type (ISOFIX) (installing) 53
 - Notes on risks and dangers 47
 - Securing on the front passenger seat 58
 - Securing on the rear seat 56
 - Top Tether 55
- Children**
 - Avoiding dangers in the vehicle 47
 - Basic instructions 46
 - Special seat belt retractor 52
- Cigarette lighter**
 - Front center console 103
 - Rear passenger compartment 103
- Cleaning**
 - see Care

Climate control

3-zone automatic climate control panel	122
Activating/deactivating	123
Activating/deactivating the A/C function (control panel)	123
Activating/deactivating the A/C function (multimedia system)	123
Activating/deactivating the synchronization function (multimedia system)	124
Air distribution settings	124
Air-recirculation mode	124
Automatic control	123
Climate style function	123
Filling capacity for PAG oil	409
Front air vents	125
Ionization	124
Note	122
Rear air vents	125
Rear operating unit	122
Refrigerant	408
Refrigerant filling capacity	409
Removing condensation from the windows	124
Residual heat	124

Setting the climate style	123
Ventilating the vehicle (convenience opening)	70
Windshield heater	125

Climate style

Function	123
Setting	123

Cockpit

Overview	6
----------------	---

Coffee cup symbol

see ATTENTION ASSIST

COMAND

see Multimedia system

COMAND Touch

Managing devices	241
------------------------	-----

Combination switch

.....	110
-------	-----

Compass

.....	271
-------	-----

Computer

see On-board computer

Connection status

Displaying	296
Overview	295

Connectivity

Switching transmission of the vehicle position on/off	238
---	-----

Contacts

.....	280
Calling up	281
Deleting	282
Downloading (from mobile phone)	280
Importing	281
Importing (overview)	281
Information	280
Making a call	282
Name format	281
Options	282
Storing	282

Controller

Operating	229
-----------------	-----

Convenience closing feature

.....	71
-------	----

Convenience opening

.....	70
-------	----







Coolant (engine)



















Check level	341
Filling capacity	407
Notes	407





















Copyright















Licenses	29
----------------	----

- Trademarks 29
 - Cross Traffic Alert** 189
 - Cruise control** 165
 - Buttons 166
 - Calling up a speed 166
 - Function 165
 - Requirements: 166
 - Selecting 166
 - Setting a speed 166
 - Storing a speed 166
 - Switching off 166
 - Switching on 166
 - System limitations 165
 - Cup holder** 101
 - Installing/removing (center console) ... 101
 - Rear passenger compartment 102
 - Customer Assistance Center (CAC)** 25
 - Customer Relations Department** 25
- D**
- Damage detection (parked vehicle)** 157
 - Dashboard**
 - see Cockpit
 - Dashboard lighting**
 - see Instrument cluster lighting
 - Data acquisition**
 - Vehicle 26
 - Data import/export** 242
 - Function/notes 242
 - Importing/exporting 242
 - Data storage**
 - Electronic control units 26
 - Online services 27
 - Vehicle 26
 - Date**
 - Setting the time and date automati-
cally 237
 - Daytime running lamp mode**
 - see Daytime running lights
 - Daytime running lights** 113
 - Switching on/off 113
 - Deactivating the alarm (ATA)** 77
 - Dealership**
 - see Qualified specialist workshop
 - Declaration of conformity**
 - Wireless vehicle components 23
 - Decorative foil (cleaning instructions)**
 - 346
 - Definitions (tires and loading)** 386
 - Designs**
 - Menu (on-board computer) 204
 - Destination** 263
 - Editing intermediate destinations 252
 - Editing the previous destinations 263
 - External 263
 - Saving (current vehicle position) 263
 - Saving as global favorite 263
 - Storing a map position 263
 - Destination entry** 248
 - Entering 3 word addresses 254
 - Entering a POI or address 248
 - Entering an intermediate destination .. 252
 - Entering geo-coordinates 253
 - Selecting a contact 253
 - Selecting a POI 251
 - Selecting from the map 254
 - Selecting previous destinations 251
 - Detecting inattentiveness**
 - see ATTENTION ASSIST
 - Diagnostics connection** 23

- Differential locks** 145
 - Engaging/disengaging 146
- Differential locks**
 - see Differential locks
- Digital Operator's Manual** 18
- Digital speedometer** 207
- Dinghy towing**
 - see Tow-bar system
- DIRECT SELECT lever** 138
 - Engaging drive position 139
 - Engaging neutral 139
 - Engaging park position 139
 - Engaging park position automatically .. 139
 - Engaging reverse gear 139
 - Function 138
- Display**
 - Care 350
- Display (multimedia system)**
 - Settings 236
- Display (on-board computer)**
 - Displays on the multifunction display .. 205
- Display content**
 - Setting the additional value range 204
- Display message** 413
 - Calling up (on-board computer) 413
 - Notes 413
- Display messages**
 -  --- mph 432
 -  --- mph 431
 -  12 V Battery See Operator's Manual 435
 - Active Brake Assist Functions Currently Limited See Operator's Manual 426
 - Active Brake Assist Functions Limited See Operator's Manual 425
 - Active Distance Assist Currently Unavailable See Operator's Manual 431
 - Active Distance Assist Inoperative 431
 - Active Distance Assist Now Available .. 431
 -  Active Headlamps Inoperative 456
 - Active Lane Keeping Assist Camera View Restricted See Operator's Manual 432
- Active Lane Keeping Assist Currently Unavailable See Operator's Manual 430
- Active Lane Keeping Assist Inoperative 429
- Active Parking Assist and PARKTRONIC Inoperative See Operator's Manual 433
- Adaptive Highbeam Assist Camera View Restricted See Operator's Manual 458
- Adaptive Highbeam Assist Currently Unavailable See Operator's Manual 457
- Adaptive Highbeam Assist Inoperative 457
- Air Intake Malfunction See Operator's Manual 453
- Apply Brake to Shift from 'P' 440
-  ATTENTION ASSIST Inoperative ... 430
-  ATTENTION ASSIST: Take a Break! 429

- | | | | | | |
|---|-----|--|-----|---|-----|
|  Automatic Headlamp Mode | |  Coolant Too Hot Stop Vehicle | | Driver's Door Open & Transmission | |
| Inoperative | 457 | Turn Engine Off | 436 | Not in P Risk of Vehicle Rolling Away ... | 441 |
| Auxiliary Battery Malfunction | 441 | Cruise Control Inoperative | 432 |  Engine Oil Level Cannot Be Measured | 437 |
| Blind Spot Assist Currently Unavailable See Operator's Manual | 432 | Cruise Control Off | 432 |  Engine Oil Level Low Stop Vehicle Turn Engine Off | 438 |
| Blind Spot Assist Inoperative | 429 |  Currently Unavailable See Operator's Manual | 421 |  Engine Oil Pressure Stop Switch Off Engine | 438 |
| Blind Spot Assist Not Available When Towing a Trailer See Operator's Manual | 429 |  Currently Unavailable See Operator's Manual | 414 |  Engine Oil Reduce Oil Level | 437 |
|  Check Brake Fluid Level | 419 | Decrease Speed | 445 | Fording Not Possible Service Required | 453 |
| Check Brake Pads See Operator's Manual | 427 | Desert Drive Program Act. ESP Unavailable See Operator's Manual ... | 449 |  Front Left Malfunction Service Required (Example) | 426 |
| Check Coolant Level See Operator's Manual | 434 |  Different. Lock Sys. Malfunction | 450 | Front Passenger Airbag Disabled See Operator's Manual | 424 |
|  Check Engine Oil Level (Add 1 quart) | 439 |  Different. Locking Sys. Cooling Down Please Wait | 452 | Front Passenger Airbag Enabled See Operator's Manual | 423 |
|  Check Left Low Beam (Example) | 456 | Differential Lock Engaged ABS and ESP Unavailable | 448 | Front/Rear Differential Lock System Malfunction | 447 |
|  Check Tires | 442 | Disengage LOW RANGE Differential Locks | 450 |  Fuel Level Low | 437 |
|  Check Washer Fluid | 455 |  Don't Forget Your Key | 447 | | |

 Gas Cap Loose	436	LOW RANGE Malfunction To Park, Apply Brake	451	 Off	430
Gearbox Protection Limit 18 mph Disable LOW RANGE	452	LOW RANGE Max. Speed 6 mph	452	 Off	428
 Hazard Warning Flashers Mal- functioning	457	LOW RANGE Max. Speed 12 mph	452	Only Shift to 'P' when Vehicle is Sta- tionary	441
 Inoperative See Operator's Manual	422	LOW RANGE Max. Speed 25 mph	451	 Parking Brake See Operator's Manual	415
 Inoperative See Operator's Manual	422	LOW RANGE Max. Speed 40 mph	451	 Place the Key in the Marked Space See Operator's Manual	447
 EBD Inoperative See Operator's Manual	419	LOW RANGE Shift to Position N Briefly	451	 Please Correct Tire Pressure	443
 SOS Inoperative	426	LOW RANGE Shifting Canceled Please Reactivate	452	 Please Release Parking Brake	418
 Intell. Light System Inoperative ...	455	LOW RANGE Stop Apply Parking Brake	450	PRE-SAFE Inoperative See Opera- tor's Manual	425
 Key Not Detected (red display message)	446	Malfunction Drive at Max. 50 mph	429	Radar Sensors Dirty See Operator's Manual	420
 Key Not Detected (white dis- play message)	446	 Malfunction See Operator's Manual	456	 Replace Key Battery	447
 Left Side Curtain Airbag Mal- function Service Required (Example) ...	423	Mercedes me connect Services Limi- ted See Operator's Manual	425	Reversing Not Possible Service Required	441
LOW RANGE Malfunction	451	N Permanently Active Risk of Rolling Away	440	 See Operator's Manual	434
		 Obtain a New Key	446	Service Required Do Not Shift Gears Visit Dealer	440

- Speed Max. 6 mph (yellow display message) 453
-  SRS Malfunction Service Required 427
-  Steering Malfunction Increased Physical Effort See Operator's Manual 454
-  Steering Malfunction Stop Immediately See Operator's Manual ... 453
- Stop Vehicle Leave Engine Running Wait Transmission Cooling 440
-  Stop Vehicle Leave Engine Running 434
-  Stop Vehicle See Operator's Manual 435
-  Suspended 431
-  Switch Off Lights 456
-  Switch On Headlamps 457
-  Tire Press. Monitor Currently Unavailable 444
-  Tire Press. Monitor Inoperative ... 444
-  Tire Pressure Monitor Inoperative No Wheel Sensors 444
- Tires Overheated 445
- To Deselect P or N, Depress Brake and Start Engine 440
- To Engage Transmiss. Position R First Depress the Brake 441
- Traffic Sign Assist Camera View Restricted See Operator's Manual 428
- Traffic Sign Assist Currently Unavailable See Operator's Manual 430
- Traffic Sign Assist Inoperative 430
- Transmission Malfunction Stop 439
-  Turn On the Ignition to Release the Parking Brake 414
-  Warning Tire Malfunction 442
-  Wheel Sensor(s) Missing 444
- Distance control**
see Active Distance Assist DISTRONIC
- Distance recorder**
see Trip distance
- DISTRONIC**
see Active Distance Assist DISTRONIC
- Door**
- Child safety lock (rear door) 59
 - Locking (emergency key) 68
 - Opening (from the inside) 67
 - Unlocking (emergency key) 68
 - Unlocking (from the inside) 67
- Door control panel** 14
- DOT, Tire Identification Number (TIN)** ... 382
- Drawbar**
see Tow-bar system
- Drinking and driving** 128
- Drinks holder**
see Cup holder
- Drive Away Assist** 188
- Drive position**
Inserting 139
- Drive program**
see G-Mode

- Drive program display** 136
- Drive programs**
see DYNAMIC SELECT
- Driver's seat**
see Seat
- Driving lights**
see Automatic driving lights
- Driving safety system** 158
ABS (Anti-lock Brake System) 159
Active Brake Assist 162
BAS (Brake Assist System) 160
EBD (electronic brake force distribution) 162
ESP® trailer stabilization 162
Off-road ABS 159
Overview 159
Radar sensors 158
Responsibility 158
- Driving system**
see 360° Camera
see Active Distance Assist DISTRONIC
see Active Lane Keeping Assist
see Active Parking Assist
see ATTENTION ASSIST
- see Blind Spot Assist
see Cruise control
see Driving safety system
see HOLD function
see Parking Assist PARKTRONIC
see Rear view camera
see Traffic Sign Assist
- Driving tips**
Drinking and driving 128
General driving tips 128
Notes on breaking-in a new vehicle 128
- Drowsiness detection**
see ATTENTION ASSIST
- Dynamic handling control system**
see ESP® (Electronic Stability Program)
- DYNAMIC SELECT** 135
Configuring drive program I 136
Displaying engine data 137
Displaying vehicle data 137
Drive program display 136
Drive programs 135
Function 135
Operating (DYNAMIC SELECT switch)
..... 136
- Selecting the drive program 136
Showing operation feedback 136
- DYNAMIC SELECT switch**
Adjustable damping 172
- E**
- E10** 404
- Easy entry feature**
Function/notes 88
Setting 89
- Easy exit feature**
Function/notes 88
Setting 89
- EBD (electronic brake force distribution)**
Function/notes 162
- ECO display**
Function 134
Resetting 208
- ECO start/stop function** 133
Automatic engine start 133
Automatic engine stop 133
Method of operation 133

- Switching off/on 134
- Electric parking brake** 155
 - Applying automatically 155
 - Applying or releasing manually 156
 - Emergency braking 157
 - Releasing automatically 156
- Electronic Stability Program**
 - see ESP® (Electronic Stability Program)
- Emergency**
 - First-aid kit (soft sided) 354
 - Overview of the help functions 16
 - Reflective safety vest 353
 - Removing the warning triangle 354
 - Setting up the warning triangle 354
- Emergency braking** 157
 - see BAS (Brake Assist System)
- Emergency call system**
 - see Mercedes-Benz emergency call system
- Emergency engine start** 367
- Emergency key**
 - Locking a door 68
 - Unlocking a door 68
- Emergency operation mode**
 - Starting the vehicle 127
- Emergency spare wheel** 397
 - Notes 397
- Emergency Tensioning Devices**
 - Activation 32
- Engine**
 - ECO start/stop function 133
 - Engine number 401
 - Starting (emergency operation mode) 127
 - Starting (start/stop button) 127
 - Starting assistance 360
 - Switching off (start/stop button) 149
- Engine data**
 - Displaying 137
- Engine number** 401
- Engine oil** 340
 - Additives 405
 - Capacity 406
 - Checking the oil level using the on-board computer 339
 - MB-Freigabe or MB-Approval 406
 - Quality 406
- Topping up 340
- Entering characters**
 - Function/notes 234
- ESC (Electronic Stability Control)**
 - see ESP® (Electronic Stability Program)
- ESP®**
 - Trailer stabilization 162
- ESP® (Electronic Stability Program)** 160
 - Activating/deactivating 161
 - Function/notes 160
- Exterior lighting**
 - Care 348
- Exterior lighting**
 - see Lights
- Exterior mirrors** 118, 119
 - Anti-glare mode (automatic) 119
 - Automatic mirror folding function 120
 - Folding in/out 118
 - Operating the memory function 89
 - Parking position 120
 - Setting 118
- External device**
 - Locking (child safety lock) 241

Eyeglasses compartment 93

F

Fatigue detection

see ATTENTION ASSIST

Favorites

Adding 232
 Calling up 231
 Deleting 232
 Moving 232
 Overview 231
 Renaming 232

First-aid kit (soft sided) 354

Flat tire 355

Changing a wheel 393
 Notes 355
 Spare wheel 355

Flat towing

see Tow-bar system

Floor mats 108

Foil covering

Radar sensors 158

Folding back the rear bench seat 96

Free software 29

Frequencies

Two-way radio 400

Frequency band

Dialing (on-board computer) 210

Front airbag (driver, front passenger) 38

Fuel 405

Additives 405
 E10 404
 Fuel reserve 405
 Gasoline 404
 Quality (gasoline) 404
 Refueling 147
 sulfur content 404
 Tank content 405

Fuel consumption

On-board computer 207

Function seat

see Door control panel

Fuses 367

Before replacing a fuse 367
 Dashboard fuse box 368
 Fuse assignment diagram 367

Fuse box in the engine compartment .. 368

Fuse box in the rear passenger compartment 368

Notes 367

Fuses

see Fuses

G

G-Mode 137

Garage door opener

Clearing the memory 153
 Opening or closing the door 153
 Programming buttons 150
 Radio equipment approval numbers 153
 Resolving problems 152
 Synchronizing the rolling code 152

Gas station search

Starting automatic search 252
 Switching automatic search on/off 257
 Using automatic search 257

Gasoline 404

Gearshift recommendation 141

Genuine parts 19

- Glide mode** 141
- Glove box**
Locking/unlocking 93
- H**
- Handbrake**
see Electric parking brake
- Handling characteristics (unusual)** 370
- Hazard warning lights** 111
- Head restraint**
Front (luxury head restraint) 82
Rear (installing/removing) 83
Rear passenger compartment
(adjusting) 83
- Headliner (care)** 350
- Headphones (Rear Seat Entertainment System)**
Connecting 329
Disconnecting 329
Overview 329
- High beam**
Switching on/off 110
- HIGH RANGE**
Shifting 144
- High-beam flasher** 110
- High-beam headlamps**
Adaptive Highbeam Assist 111
- Hill start assist** 171
- HOLD function** 171
Function/notes 171
Switching on/off 172
- Hood**
Opening/closing 337
- Hotspot**
Setting up (Wi-Fi) 240
- I**
- Identification plate**
Engine 401
Refrigerant 408
Vehicle 401
- Ignition**
Switching on (Start/Stop button) 126
- Ignition key**
see SmartKey
- Immobilizer** 76
- Indicator lamps**
see Warning/indicator lamps
- Individual drive program**
Configuring 136
Selecting 136
- Inside rearview mirror**
see Exterior mirrors
- Inspection**
see ASSYST PLUS
- Instrument cluster**
see Instrument Display
- Instrument cluster lighting** 206
- Instrument Display** 201
Adjusting the lighting 206
Function/notes 201
Instrument cluster 8
Setting the additional value range 204
Warning/indicator lamps 458
- Intelligent Light System**
Adaptive Highbeam Assist 111
- Interior lighting** 113
Ambient lighting 114

- | | | | | | |
|--|-----|---|-----|------------------------------------|-----|
| Reading light | 113 | Displaying the connection status | 296 | J | |
| Setting | 113 | Establishing | 295 | Jack | |
| Switch-off delay time | 114 | Information | 294 | Storage location | 392 |
| Interior motion sensor | | Restrictions | 294 | Jump-start connection | 360 |
| Activating/deactivating | 78 | Internet radio | | General notes | 359 |
| Function | 78 | Calling up | 298 | K | |
| Intermediate destination | | Deleting stations | 299 | Kickdown | 141 |
| Calculating a route with intermediate destinations | 253 | Logging out | 300 | Using | 141 |
| Entering | 252 | Overview | 299 | Knee airbag | 38 |
| Modifying | 252 | Registering | 300 | L | |
| Starting an automatic gas station search | 252 | Saving stations | 299 | Labeling (tires) | |
| Starting the automatic service station search | 258 | Selecting and connecting to a station | 299 | see Tire labeling | |
| Internet | | Selecting stream | 300 | Lamp | |
| Calling up a web page | 296 | Setting options | 300 | see Interior lighting | |
| Closing the browser | 298 | Terms of use | 300 | Lamps (Instrument Display) | |
| Deleting a bookmark | 298 | Ionization | | see Warning/indicator lamps | |
| Deleting browser data | 298 | Activating/deactivating (multimedia system) | 124 | Lane detection (automatic) | |
| Managing bookmarks | 298 | iPhone® | | see Active Lane Keeping Assist | |
| Internet connection | | see Apple CarPlay™ | | Lane Keeping Assist | |
| Communication module function | 295 | see Mercedes-Benz Link | | see Active Lane Keeping Assist | |
| Connection status | 295 | | | | |

- Language** 242
 - Notes 242
 - Setting 242
 - LATCH-type (ISOFIX) child seat securing system**
 - Installing 53
 - Light switch**
 - Overview 109
 - Lighting**
 - see Interior lighting
 - see Lights
 - Lights** 109
 - Adaptive Highbeam Assist 111
 - Adjusting the instrument lighting 206
 - Automatic driving lights 110
 - Combination switch 110
 - Hazard warning lights 111
 - High beam 110
 - High-beam flasher 110
 - Light switch 109
 - Low-beam headlamps 109
 - Parking lights 109
 - Rear fog lamp 109
 - Responsibility for lighting systems 109
 - Setting the exterior lighting switch-off delay time 113
 - Setting the surround lighting 113
 - Standing lights 109
 - Turn signals 110
 - Limited Warranty**
 - Vehicle 25
 - Live Traffic Information**
 - Displaying subscription information 264
 - Displaying the traffic map 265
 - Displaying traffic incidents 265
 - Extending a subscription 264
 - Issuing hazard alerts 266
 - Load index (tires)** 384
 - Load-bearing capacity (tires)** 384
 - Loading** 100
 - Bag hook 100
 - Cargo tie-down rings 100
 - Definitions 386
 - Notes 90
 - Roof carrier 101
 - Loading guidelines** 90
 - Loading information table** 377
 - Loads**
 - Securing 90
 - Locator lighting**
 - see Surround lighting
 - Locking differential**
 - see Differential locks
 - Locking/unlocking**
 - Emergency key 68
 - Unlocking and opening doors from the inside 67
 - LOW RANGE**
 - Shifting 144
 - Low-beam headlamps**
 - Switching on/off 109
 - Lubricant additives**
 - see Additives
 - Luggage**
 - Securing 90
- M**
- Maintenance**
 - Menu (on-board computer) 206
 - Vehicle 21

- Maintenance**
 - see ASSYST PLUS
- Malfunction**
 - Restraint system 32
- Malfunction message**
 - see Display message
- Map** 265, 266, 267
 - Avoiding an area 269
 - Avoiding an area (overview) 269
 - Changing an area 270
 - Deleting an area 270
 - Displaying the compass 271
 - Displaying the map version 269
 - Displaying the next intersecting street 269
 - Displaying the satellite map 272
 - Displaying the traffic map 265
 - Displaying weather information 272
 - Map data 271
 - Moving 268
 - Overview 266
 - Selecting POI symbols 268
 - Selecting text information 268
 - Selecting the map orientation 268
 - Setting the map scale 267
 - Setting the map scale automatically 271
 - Updating 270
- Map and compass**
 - Overview 266
- Message program**
 - Overview 84
 - Resetting the settings 85
- Message programs**
 - Selecting the front seats 85
- Message settings**
 - Resetting 85
- Matte finish (cleaning instructions)** 345
- Maximum load rating** 383
- Maximum permissible load**
 - Calculation example 379
 - Determining 378
- Maximum tire pressure** 383
- Mechanical key**
 - Inserting/removing 64
- Media**
 - Menu (on-board computer) 210
 - Searching 307
 - Starting cinema mode 313
- Media display**
 - Notes 227
- Media Interface**
 - Activating 308
 - Information 307
 - Overview 309
- Media mode**
 - Activating 301
- Media playback**
 - Operating (on-board computer) 210
- Media search**
 - Starting 307
- Media source**
 - Selecting (on-board computer) 210
- Memory function**
 - Operating 89
 - Outside mirror – Calling up stored settings 89
 - Outside mirror – Storing settings 89
 - Seat – Calling up stored settings 89
 - Seat – Storing settings 89
 - Steering wheel – Calling up saved settings 89
 - Steering wheel – Saving settings 89

Menu (on-board computer)

Assistant display	206
Designs	204
Maintenance	206
Media	210
Navigation	208
Overview	202
Radio	210
Telephone	211
Trip	207

Mercedes me connect 290

Accident and breakdown management	291
Arranging a service appointment	291
Calling the Mercedes-Benz Customer Center	290
Information	289
Making a call via the overhead control panel	290
Service call with the me button	290
Transferred data	291

Mercedes-AMG vehicles

Notes	126
-------------	-----

Mercedes-Benz Apps

Calling up	296
------------------	-----

Using voice control	296
---------------------------	-----

Mercedes-Benz emergency call system

Automatic emergency call	293
Information	292
Information on data processing	294
Manual emergency call	293
Overview	292

Mercedes-Benz Link

Connecting	285
Ending	285
Overview	284
Using	285

Message (multifunction display)

see Display message

Message memory 413**Messages**

Voice commands (Voice Control System)	224
---	-----

Messages

see Text messages

Mirrors

see Exterior mirrors

Mobile phone

Damage detection (parked vehicle)	157
Wireless charging	107

Mobile phone

see Android Auto
 see Apple CarPlay™
 see Mercedes-Benz Link
 see Second telephone
 see Telephone

Mobile phone voice recognition

Starting	279
Stopping	279

Model series

see Vehicle identification plate

Multifunction display

Overview of displays	205
----------------------------	-----

Multifunction steering wheel

Overview of buttons	202
---------------------------	-----

Multifunction steering wheel

see Steering wheel

Multimedia system 227

Activating/deactivating standby mode	158
--	-----

Adjusts the volume	233
Central control elements	228
Configuring display settings	236
Entering characters	234
Favorites	231
Main functions	231
Overview	227
Restoring the factory settings	247
Standby mode function	157
Switching the sound on or off	233
Multimedia system	
see Touch Control	
see Touchpad	

N

Navigation

Calling up the Digital Operator's Manual	272
Menu (on-board computer)	208
Showing/hiding the menu	248
Switching on	247
Updating the map data	270
Voice commands (Voice Control System)	217

Navigation

see Destination	
see Destination entry	
see Map	
see Route	
see Route guidance	
see Traffic information	

Navigation announcements

Activating/deactivating	261
Adjusting the volume	261
Repeating	262
Switching audio fadeout on/off	261

Navigation messages

On-board computer	208
-------------------------	-----

Near Field Communication (NFC)

Connecting the mobile phone to the multimedia system	278
Information	278
Switching Bluetooth® audio equipment	312
Switching mobile phones	278
Using a mobile phone	278

Neutral

Inserting	139
-----------------	-----

NFC

see Near Field Communication (NFC)	
------------------------------------	--

Non-operational time

Activating/deactivating standby mode	158
Standby mode function	157

Notes on breaking-in a new vehicle

128

O

Occupant safety

Pets in the vehicle	61
---------------------------	----

Occupant safety

see Airbag	
see Automatic front passenger front airbag shutoff	
see PRE-SAFE® (anticipatory occupant protection)	
see Restraint system	
see Seat belt	

Odometer

see Total distance	
--------------------	--

Off-road drive program

see G-Mode	
------------	--

- Off-road driving** 131
- Off-road driving**
see Off-road driving
- Oil**
see Engine oil
- On-board computer** 202
Assistance graphic menu 206
Displaying the service due date 336
Media menu 210
Menu designs 204
Menu overview 202
Multifunction display 205
Navigation system menu 208
Operating 202
Radio menu 210
Service menu 206
Telephone menu 211
Trip menu 207
- On-board diagnostics interface**
see Diagnostics connection
- Open-source software** 29
- Operating fluids**
Additives (fuel) 405
Brake fluid 406
- Coolant (engine) 407
Engine oil 405
Fuel (gasoline) 404
Notes 402
Refrigerant (air conditioning system) ... 408
Windshield washer fluid 407
- Operating safety**
Declaration of conformity (wireless
vehicle components) 23
Information 22
- Operating system**
see On-board computer
- Operator's Manual**
Vehicle equipment 20
- Operator's Manual (digital)** 18
- Overhead control panel**
Making calls (Mercedes me connect)
..... 290
Overview 12
- P**
- Paint code** 401
- Paintwork (cleaning instructions)** 345
- Panic alarm** 63
Activating/deactivating 63
- Park position**
Inserting 139
Selecting automatically 139
- Parking**
see Electric parking brake
- Parking aid**
see Parking Assist PARKTRONIC
- Parking Assist PARKTRONIC** 174
Activating 176
Adjusting warning tones 177
Function 174
Side impact protection 175
Switching off 176
System limitations 174
- Parking assistance systems**
see Active Parking Assist
- Parking brake**
see Electric parking brake
- Parking for an extended period** 157
- Parking lights** 109

- Parking position**
 - Exterior mirrors 120
 - Storing the position of the front-passenger outside mirror using reverse gear 120
 - Partition net**
 - Attaching 98
 - PASSENGER AIR BAG status display**
 - see Automatic front passenger front airbag shutoff
 - Payload**
 - Calculation example 379
 - Determining the maximum 378
 - Permitted towing methods** 362
 - Personalization**
 - see User profile
 - Pets in the vehicle** 61
 - Phone book**
 - see Contacts
 - Picture formats**
 - see Video mode
 - Picture settings**
 - see Video mode
 - PIN protection**
 - Activating/deactivating 243
 - Plastic trim (Care)** 350
 - Playback options**
 - Selecting 304
 - POI**
 - Selecting 251
 - POI symbols**
 - Selecting 268
 - Power supply**
 - Switching on (Start/Stop button) 126
 - Power washer (care)** 343
 - Power windows**
 - see Side windows
 - PRE-SAFE® (anticipatory occupant protection)** 45
 - Function 45
 - PRE-SAFE® Sound 45
 - Reversing measures 46
 - Preventative occupant protection system**
 - see PRE-SAFE® (anticipatory occupant protection)
 - Previous destinations**
 - Selecting 251
 - Programs**
 - see DYNAMIC SELECT
 - Protecting the environment**
 - Notes 19
- Q**
- QR code**
 - Rescue card 26
 - Qualified specialist workshop** 24
- R**
- Radar sensors**
 - Foil covering 158
 - Radio**
 - Activating/deactivating radio text 316
 - Calling up the station list 315
 - Deleting channels 315
 - Direct frequency entry 315
 - Displaying information 316
 - Displaying radio text 316
 - Editing station presets 315
 - Menu (on-board computer) 210

- Moving stations 315
- Overview 314
- Searching for stations 315
- Setting a channel 315
- Setting the waveband 315
- Storing radio stations 315
- Switching on 313
- Switching the HD radio function on/off 315
- Tagging music tracks 316
- Voice commands (Voice Control System) 221
- Radio stations**
 - Dialing (on-board computer) 210
- Range**
 - Displaying 207
- Reading light**
 - see Interior lighting
- Real wood (Care)** 350
- Rear bench seat**
 - Folding down 95
 - Folding forwards 95
- Rear compartment display**
 - Locking (child safety lock) 241
- Switching on/off 241
- Rear display**
 - Cleaning 327
 - Inserting in the console 325
 - Operating 327
 - Overview 324
 - Removing from the console 326
 - Switching on/off 326
- Rear door (child safety lock)** 59
- Rear fog lamp**
 - Switching on/off 110
- Rear Seat Entertainment System**
 - Activating media mode 333
 - Controlling playback 334, 335
 - Headphones overview 329
 - Homescreen overview 328
 - Information about media mode 332
 - Operating safety 322
 - Overview 324
 - Overview of the rear displays 324
- Rear view camera** 178
 - Care 348
 - Function 178
- Opening the camera cover (360° Camera) 183
- Setting favorites (360° Camera) 183
- Rear window**
 - Changing the wiper blade 117
- Rear window wipers**
 - Activating/deactivating 115
- Rear-end door**
 - Closing 68
 - Opening 68
 - Opening dimensions 409
- Recovering** 364
- Reflective safety vest** 353
- Refrigerant (air conditioning system)**
 - Notes 408
- Refueling**
 - Refueling the vehicle 147
- Reporting malfunctions relevant to safety** 25
- Rescue card** 26
- Reserve**
 - Fuel 405

Reset function (multimedia system)	247
Residual heat	124
Restoring (factory settings) see Reset function (multimedia system)	
Restraint system	31
Basic instructions for children	46
Function in an accident	32
Functionality	32
Malfunction	32
Protection	31
Reduced protection	31
Self-test	32
Warning lamp	32
Reverse gear Inserting	139
Rims (Care)	348
Roadside Assistance	21
Roadside Assistance call see Mercedes me connect	
Roll away protection see HOLD function	
Roof carrier Attaching	101

Loading	101
Route	255, 257
Calculating	255
Displaying destination information	257
Planning	252
Selecting a type	256
Selecting an alternative route	257
Selecting notifications	257
Selecting options	256
Starting the automatic service station search	258
Switching the automatic gas station search on/off	257
Using automatic gas station search	257
With intermediate destinations	253
Route guidance	258
Canceling	262
Changing direction	259
Destination reached	260
From an off-road location	262
Lane recommendations	260
Notes	258
Off-road	262
To an off-road destination	262

S

Safety systems

 see Driving safety system

Satellite map	272
----------------------------	-----

Satellite radio

Activating/deactivating TuneStart	320
Adding a channel to Smart Favorites ...	320
Deleting a channel	319
Displaying EPG information	319
Displaying service information	321
Information	316
Information about Smart Favorites and TuneStart	320
Logging in	316
Moving a channel	319
Music and sport alerts function	319
Overview	318
Pause and playback function	320
Restrictions	316
Selecting a category	319
Selecting a channel	319
Setting music and sport alerts	319
Setting the parental control	319
Storing a channel	319

- Switching on 317
- SD card**
 - Inserting/removing 301
- Seat** 79
 - Adjusting (electrically) 80
 - Adjusting the seat backrest angle (rear passenger compartment) 96
 - Correct driver's seat position 79
 - Massage program overview 84
 - Operating the memory function 89
 - Resetting the settings 85
 - Setting automatic lateral support adjustment 84
 - Setting options 14
 - Workout program overview 84
- Seat adjustment**
 - Configuring 84
- Seat belt** 33
 - Protection 33
- Seat belt adjustment**
 - Activating/deactivating 37
 - Function 37
- Seat belt warning**
 - see Seat belts
- Seat belts** 38
 - Activating/deactivating seat belt adjustment 37
 - Adjusting the height 36
 - Care 350
 - Fastening 36
 - Reduced protection 34
 - Releasing 37
 - Seat belt adjustment (function) 37
 - Warning lamp 38
- Seat cover (Care)** 350
- Seat heating**
 - Activating/deactivating 85
- Seat ventilation**
 - Switching on/off 86
- Second telephone** 276
 - Connecting 276
 - Features 276
- Selecting a gear**
 - see Changing gears
- Selector lever**
 - see DIRECT SELECT lever
- Self-test**
 - Automatic front passenger front air-bag shutoff 43
- Sensors (Care)** 348
- Service center**
 - see Qualified specialist workshop
- Service interval display**
 - see ASSYST PLUS
- Service station search**
 - Starting automatic search 258
- Setting a speed**
 - see Cruise control
- Setting summer time** 237
- Setting the date format** 237
- Setting the distance unit** 242
- Setting the map scale**
 - see Map
- Shift paddles**
 - see Steering wheel paddle shifters
- Shifting gears**
 - Gearshift recommendation 141

- Short messages**
 - see Text messages
- Side airbag** 38
- Side impact protection** 175
- Side windows** 69
 - Child safety lock in the rear passenger compartment 60
 - Closing 69
 - Closing using the SmartKey 71
 - Convenience closing feature 71
 - Convenience opening 70
 - Opening 69
 - Opening with the SmartKey 70
 - Problem 71
- Size designation (tires)** 384
- Sliding sunroof**
 - Closing 73
 - Closing using the SmartKey 71
 - Opening 73
 - Opening with the SmartKey 70
 - Problem 74
- SmartKey** 62
 - Acoustic locking verification signal 63
 - Battery 64
 - Energy consumption 63
 - Features 62
 - Key ring attachment 64
 - Mechanical key 64
 - Overview 62
 - Panic alarm 63
 - Problem 65
 - Unlocking setting 63
- SmartKey functions**
 - Deactivating 63
- Smartphone**
 - see Android Auto
 - see Apple CarPlay™
 - see Mercedes-Benz Link
 - see Telephone
- Snow chains** 371
- Socket (12 V)** 104
 - Cargo compartment 105
 - Front center console 104
 - Rear passenger compartment 104
- Socket (115 V)** 104
 - Cargo compartment 104
- Software update** 245
 - Important system updates 246
- Information 245
- Performing 246
- Sound**
 - PRE-SAFE® Sound 45
 - Wheels and tires 370
- Sound**
 - see Burmester® surround sound system
 - see Sound settings
- Sound settings** 321
 - Adjusting the balance/fader 321
 - Adjusting treble, mid-range and bass settings 321
 - Automatic volume adjustment 321
 - Calls up the sound menu 321
 - Information 321
- Spare wheel** 355
- Spare wheel**
 - see Emergency spare wheel
 - see Spare wheel
- Spare wheel bracket**
 - Rear-end door 355
- Special seat belt retractor** 52
- Specialist workshop** 24

- Speech dialog system**
see Voice Control System
- Speed index (tires)** 384
- Speed Limit Assist**
Setting 193
- Speedometer**
Digital 207
- Standby mode**
Activating/deactivating 158
Function 157
- Standing lights** 109
- Start/Stop button**
Parking the vehicle 149
Starting the vehicle 127
Switching on the power supply or
ignition 126
- Start/stop function**
see ECO start/stop function
- Starting assistance**
see Jump-start connection
- Starting the engine**
see Vehicle
- Starting-off aid**
see Hill start assist
- Station**
Deleting 315
Direct frequency entry 315
Moving 315
Searching 315
Setting 315
Storing 315
- Station list**
Calling up 315
- Station presets**
Editing 315
Modifying 315
- Steering wheel** 202
Adjusting (electrically) 87
Buttons 202
Operating the memory function 89
Steering wheel heater 87
- Steering wheel heater**
Switching on/off 87
- Steering wheel paddle shifters** 140
- Stowage areas**
see Loading
see Stowage compartment
- Stowage compartment** 92
Armrest 92
Center console 92
Door 92
Eyeglasses compartment 93
Glove box 92
- Stowage compartments**
see Loading
see Stowage compartment
- Sulfur content** 404
- Sun visor**
Operating 121
- Surround lighting** 113
Setting 113
- Surround View**
see 360° Camera
- Switch-off delay time**
Exterior 113
Interior 114

Switching the surround sound on/off	
Burmester® surround sound system ...	322
Synchronization function	
Activating/deactivating (multimedia system)	124
System settings	
Activating/deactivating PIN protection	243
Reset function (multimedia system)	247
Setting the distance unit	242
Setting the time and date automatically	237
Setting the time zone	237
Setting the time/date format	237
Switching transmission of the vehicle position on/off	238
System settings	
see Bluetooth®	
see Data import/export	
see Language	
see Software update	
see Wi-Fi	

T

Tailpipes (Care)	348
Tank content	
Fuel	405
Reserve (fuel)	405
Technical data	
Axle load (trailer operation)	412
Information	399
Notes (trailer hitch)	411
Tire pressure monitor	377
Tongue weight	412
Towing capacity (trailer operation)	411
Vehicle identification plate	401
Telephone	211, 274
Activating functions during a call	279
Call and ringtone volume	279
Calls with several participants	279
Connecting a mobile phone (Near Field Communication (NFC))	278
Connecting a mobile phone (Pass-key)	275
Connecting a mobile phone (Secure Simple Pairing)	275
De-authorizing a mobile phone	277

Disconnecting a mobile phone	277
Importing contacts	281
Importing contacts (overview)	281
Incoming call during an existing call ...	280
Information	275
Interchanging mobile phones	277
Menu (on-board computer)	211
Mobile phone voice recognition	279
Notes	272
Operating modes	275
Reception and transmission volume ...	278
Switching mobile phones (Near Field Communication (NFC))	278
Telephone menu overview	274
Telephone operation	279
Using Near Field Communication (NFC)	278
Voice commands (Voice Control System)	220
Wireless charging (mobile phone)	107

Telephone

see Second telephone

Telephone number

Dialing (on-board computer)

211

Telephony operating modes

Bluetooth® Telephony 275

Telephony operating modes

see Second telephone

Temperature grade 381**Text messages** 283

Calling a message sender 284

Changing folders 284

Composing 283

Configuring the displayed text messages 283

Deleting 284

Drafts 284

Notes 283

Options 284

Outbox 284

Read-aloud function 283

Reading 283

Replying 284

Sending 283

Voice commands (Voice Control System) 224

Through-loading feature in the rear**passenger compartment** 93**Time**

Manual time setting 237

Setting summer time 237

Setting the time and date automatically 237

Setting the time zone 237

Setting the time/date format 237

TIN (Tire Identification Number) 382**Tire and Loading Information placard** ... 377**Tire characteristics** 384**Tire information table** 377**Tire labeling** 381

Characteristics 384

DOT, Tire Identification Number (TIN) 382

Load index 384

Load-bearing capacity 384

Maximum tire load 383

Maximum tire pressure 383

Overview 381

Speed rating 384

Temperature grade 381

Tire Quality Grading 381

Tire size designation 384

Traction grade 381

Tread wear grade 381

Tire load (maximum) 383**Tire pressure** 373, 374

Checking (manually) 374

Checking (tire pressure monitoring system) 376

Maximum 383

Notes 371

Restarting the tire pressure monitoring system 376

Tire pressure monitoring system (function) 374

Tire pressure table 373

Tire pressure monitor

Restarting 376

Technical data 377

Tire pressure monitoring system

Checking the tire pressure 376

Checking the tire temperature 376

Function 374

Tire pressure table 373**Tire Quality Grading** 381

- Tire temperature**
 - Checking (tire pressure monitoring system) 376
 - Tire pressure monitoring system (function) 374
- Tire tread** 370
- Tire-change tool kit**
 - see Vehicle tool kit
- Tires**
 - Changing hub caps 393
 - Characteristics 384
 - Checking 370
 - Checking the tire pressure (manually) 374
 - Checking the tire pressure (tire pressure monitoring system) 376
 - Definitions 386
 - DOT, Tire Identification Number (TIN) 382
 - Flat tire 355
 - Installing 396
 - Load index 384
 - Load-bearing capacity 384
 - Maximum tire load 383
 - Maximum tire pressure 383
 - Noise 370
 - Notes on installing 389
 - Overview of tire labeling 381
 - Removing 395
 - Replacing 389, 393
 - Restarting the tire pressure monitoring system 376
 - Rotating 391
 - Selection 389
 - Snow chains 371
 - Speed rating 384
 - Storing 392
 - Temperature grade 381
 - Tire and Loading Information placard .. 377
 - Tire pressure (notes) 371
 - Tire pressure monitoring system (function) 374
 - Tire pressure table 373
 - Tire Quality Grading 381
 - Tire size designation 384
 - Traction grade 381
 - Tread wear grade 381
 - Unusual handling characteristics 370
- Toll system**
 - Windshield 121
- Tongue weight** 412
- Top Tether** 55
- Total distance** 207
 - Displaying 207
- Touch Control** 228
 - On-board computer 202
 - Operating 228
 - Setting the sensitivity 228
- Touchpad** 229
 - Activating/deactivating haptic operation feedback 230
 - Operating 229
 - Reading the handwriting recognition aloud 230
 - Selecting a station and track 230
 - Setting the sensitivity 230
 - Switching on/off 229
- Tow-away alarm**
 - Activating/deactivating 77
 - Function 77
- Tow-bar system** 200
- Tow-starting** 367

Tow-starting and towing away		Traffic information	264	Transfer case	
Towing eye	366	Displaying the traffic map	265	HIGH RANGE	143
Towing a trailer		Displaying traffic incidents	265	LOW RANGE	143
Coupling up/uncoupling a trailer	199	Extending a Live Traffic Information subscription	264	Shifting	144
Notes	198	Issuing hazard warnings	266	Transferred vehicle data	
Socket	199	Live Traffic Information	264	Android Auto	288
Towing away	363	Overview	264	Apple CarPlay™	288
Towing away in the event of front axle damage	365	Traffic map		Transmission (problem)	142
Towing away in the event of malfunc- tions	365	see Map		Transmission position display	138
Towing away in the event of malfunc- tions (notes)	365	Traffic Sign Assist	191	Transporting	
Towing away in the event of rear axle damage	365	Function/notes	191	Vehicle	365
Towing eye		System limitations	191	Tread wear grade	381
Position	366	Trailer stabilization		Trim element (Care)	350
Towing methods	362	Function/notes	162	Trip	
Track		Trailer tow hitch		Menu (on-board computer)	207
Selecting (audio mode)	304	Axle load	412	Trip computer	
Traction grade	381	Care	348	Displaying	207
		Coupling up/uncoupling a trailer	199	Resetting	208
		General notes	411	Trip distance	207
		Notes	198	Displaying	207
		Socket	199	Resetting	208
		Tongue weight	412		
		Towing capacity	411		

Trip odometer	
see Trip distance	
Turn signal indicator	
see Turn signals	
Turn signals	110
Switching on/off	110
Two phone mode	
see Second telephone	
Two-way radios	
Frequencies	400
Notes on installation	399
Transmission output (maximum)	400
U	
Units of measurement	
Setting	242
Unlocking setting	63
USB devices	
Connecting	304
USB port	106
User profile	244
Creating	244
Importing/exporting	244

Options	245
Setting	244

Using the telephone

see Calls

V

Vehicle	127
Activating/deactivating standby mode	158
Correct use	24
Damage detection (parking)	157
Data acquisition	26
Data storage	26
Diagnostics connection	23
Equipment	20
Limited Warranty	25
Locking (from the inside)	67
Locking/unlocking (emergency key)	68
Lowering	396
Maintenance	21
Parking for an extended period	157
Problem notification	25
QR code rescue card	26
Qualified specialist workshop	24
Raising	393

Standby mode function	157
Starting (emergency operation mode)	127
Starting (start/stop button)	127
Switching off (start/stop button)	149
Towing	200
Unlocking (from the inside)	67
Ventilating (convenience opening)	70
Voice commands (Voice Control System)	225

Vehicle data

Angle of approach/departure	410
Displaying (DYNAMIC SELECT)	137
Fording depth	410
Maximum gradient-climbing capability	410
Minimum ground clearance	409
Transferring to Android Auto™	288
Transferring to Apple CarPlay™	288
Turning circle	409
Vehicle height	409
Vehicle length	409
Vehicle width	409
Weights	410
Wheelbase	409

- Vehicle data storage**
 - Event data recorders 28
 - Multimedia system/Mercedes me connect 28
- Vehicle dimensions** 409
- Vehicle electronics**
 - Notes 399
 - Two-way radios 399
- Vehicle identification number**
 - see VIN
- Vehicle identification plate** 401
 - Paint code 401
 - VIN 401
- Vehicle key**
 - see SmartKey
- Vehicle maintenance**
 - see ASSYST PLUS
- Vehicle operation**
 - Outside the USA or Canada 21
- Vehicle position**
 - Switching transmission on/off 238
- Vehicle tool bag** 392
- Vehicle tool kit** 392
 - Overview 392
- Ventilating**
 - Convenience opening 70
- Vents**
 - see Air vents
- Video mode** 307
 - Activating 305
 - Activating/deactivating full-screen mode 307
 - Overview 306
 - Settings 307
- VIN** 401
 - Identification plate 401
 - Seat 401
 - Windshield 401
- Vision**
 - Removing condensation from the windows 124
 - Windshield heater 125
- Voice command types (Voice Control System)** 214
- Voice Control System** 213
 - Application specific voice commands .. 214
 - Audible help functions 215
 - Global voice commands 214
 - Improving speech quality 215
 - Language setting 215
 - Media player voice commands 222
 - Message voice commands 224
 - Multifunction steering wheel (operating) 213
 - Navigation voice commands 217
 - Operable functions 214
 - Operating safety 213
 - Radio voice commands 221
 - Switch voice commands 215
 - Telephone voice controls 220
 - Text message voice commands 224
 - Types of voice commands 214
 - Vehicle voice commands 225
 - Voice prompting 214
- Voice control system**
 - see Voice Control System

W

Warning lamps

see Warning/indicator lamps

Warning system

see ATA (anti-theft alarm system)

Warning triangle

Removing 354

Setting up 354

Warning/indicator lamp

 ABS warning lamp 463

 BRAKE Brake warning lamp (USA) 462

 Brakes warning lamp (Canada) 462

 Coolant warning lamp 468

 Electrical malfunction warning lamp 467

 Engine diagnosis warning lamp ... 467

 ESP® OFF warning lamp 461

 ESP® warning lamp flashes 461

 ESP® warning lamp lights up 464

 Fuel reserve warning lamp .. 467, 468

 Power steering system warning lamp 471

 Red indicator lamp, electric parking brake applied (Canada only) ... 460

 PARK Red indicator lamp, electric parking brake applied (USA only) 460

 Restraint system warning lamp ... 464

 Seat belt warning lamp flashes ... 465

 Seat belt warning lamp lights up 466

 Tire pressure monitoring system warning lamp flashes 470

 Tire pressure monitoring system warning lamp lights up 469

 Trailer tow hitch warning lamp 471

 Warning lamp for distance warning function 466

 Yellow electric parking brake indicator lamp is malfunctioning 460

Warning/indicator lamps 458

Overview 458

PASSENGER AIR BAG 43

Warranty 25

Washer fluid

see Windshield washer fluid

Washing by hand (care) 344

Water tank

see Air-water duct

Weather information 272

Web browser

Calling up a web page 296

Calling up options 297

Calling up the settings 297

Deleting a bookmark 298

Deleting browser data 298

Ending 298

Managing bookmarks 298

Overview 297

Showing/hiding the menu 296

Website

Calling up 296

- Showing/hiding the web browser menu 296
- Wheel change**
 - Lowering the vehicle 396
 - Mounting a new wheel 396
 - Removing a wheel 395
 - Removing/installing hub caps 393
- Wheel rotation** 391
- Wheels**
 - Care 348
 - Changing hub caps 393
 - Checking 370
 - Checking the tire pressure (manually) 374
 - Checking the tire pressure (tire pressure monitoring system) 376
 - Definitions 386
 - DOT, Tire Identification Number (TIN) 382
 - Flat tire 355
 - Installing 396
 - Load index 384
 - Load-bearing capacity 384
 - Maximum tire load 383
 - Maximum tire pressure 383
- Noise 370
- Notes on installing 389
- Overview of tire labeling 381
- Removing 395
- Replacing 389, 393
- Restarting the tire pressure monitoring system 376
- Rotating 391
- Selection 389
- Snow chains 371
- Speed rating 384
- Storing 392
- Temperature grade 381
- Tire and Loading Information placard .. 377
- Tire characteristics 384
- Tire pressure (notes) 371
- Tire pressure monitoring system (function) 374
- Tire pressure table 373
- Tire Quality Grading 381
- Tire size designation 384
- Traction grade 381
- Tread wear grade 381
- Unusual handling characteristics 370
- Wi-Fi** 238
 - Overview 238
 - Setting 239
 - Setting up a hotspot 240
- Window curtain airbag** 38
- Windows**
 - see Side windows
- Windows (Care)** 348
- Windshield** 116
 - Radio waves 121
 - Replacing the wiper blades 116
- Windshield**
 - see Windshield
- Windshield heater** 125
- Windshield heating**
 - see Windshield heater
- Windshield washer fluid** 407
 - Notes 407
- Windshield washer system**
 - Topping up 342
- Windshield wipers**
 - Activating/deactivating 115

Replacing the wiper blades	116
Winter operation	
Snow chains	371
Wiper blades	
Care	348
Replacing	116
Wireless charging	
Function/notes	106
Mobile phone	107
Wireless vehicle components	
Declaration of conformity	23
Workout program	
Overview	84
Workshop	
see Qualified specialist workshop	

